

Taf. 1



Abb. 1 Gordion, Plan der Nekropole

Quelle: Kohler (1995) Abb. 1.

Taf. 2

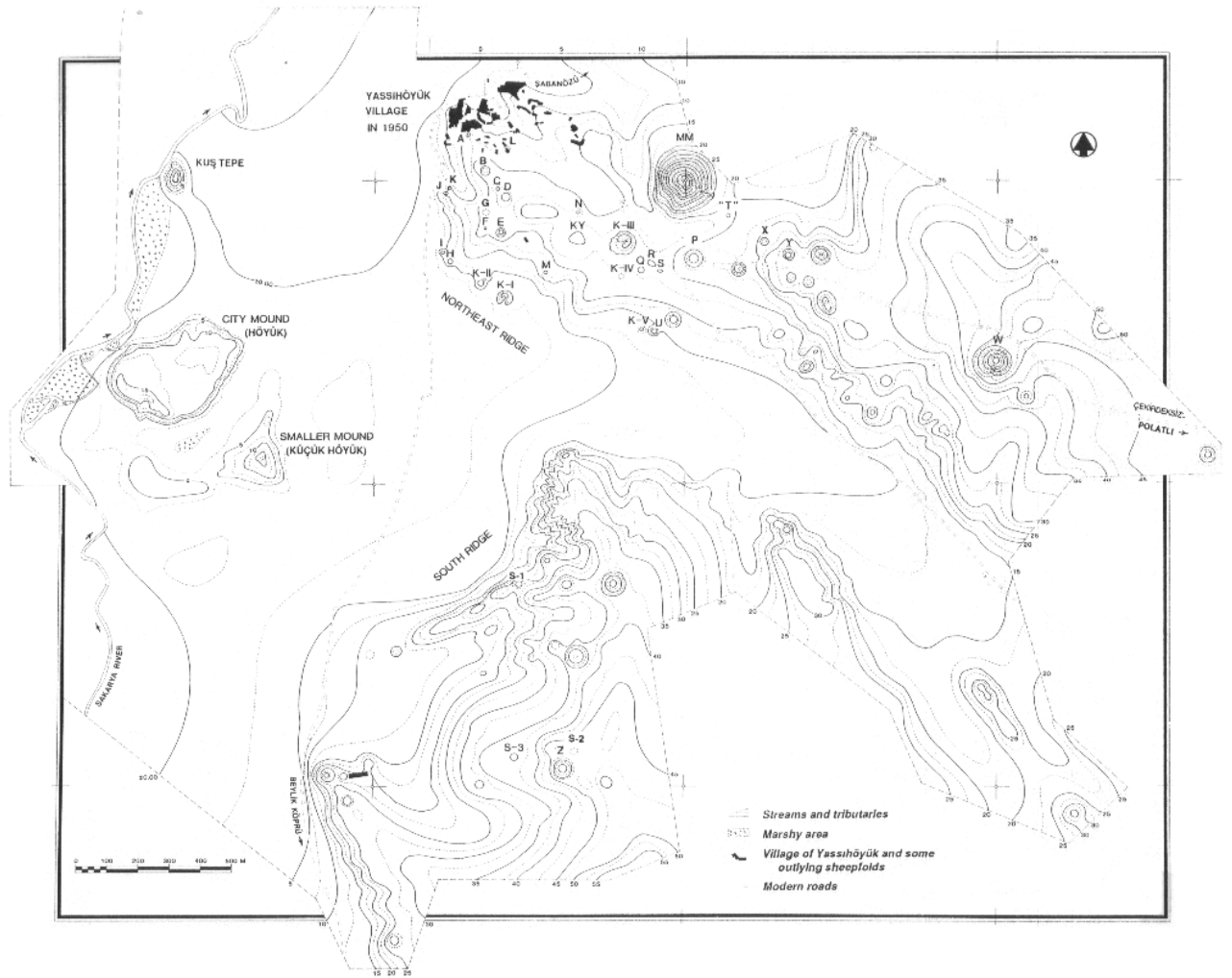

Abb.1 Tumulus W, Schnitt

Quelle: Young (1981) 192 Abb. 114 oben.

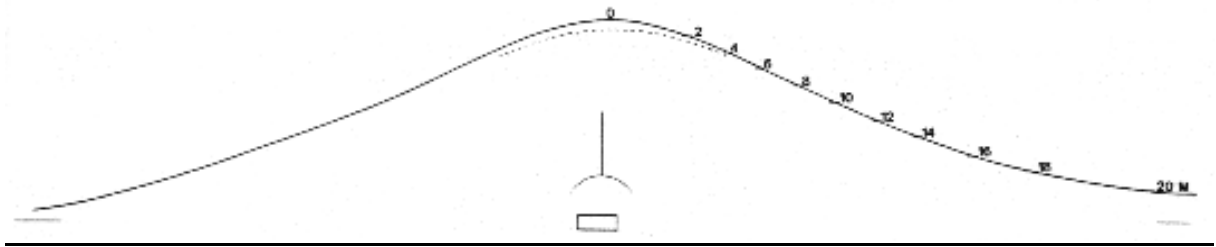

Abb.2 Tumulus W, Plan

Quelle: Young (1981) 192 Abb. 114 unten.

Taf. 3

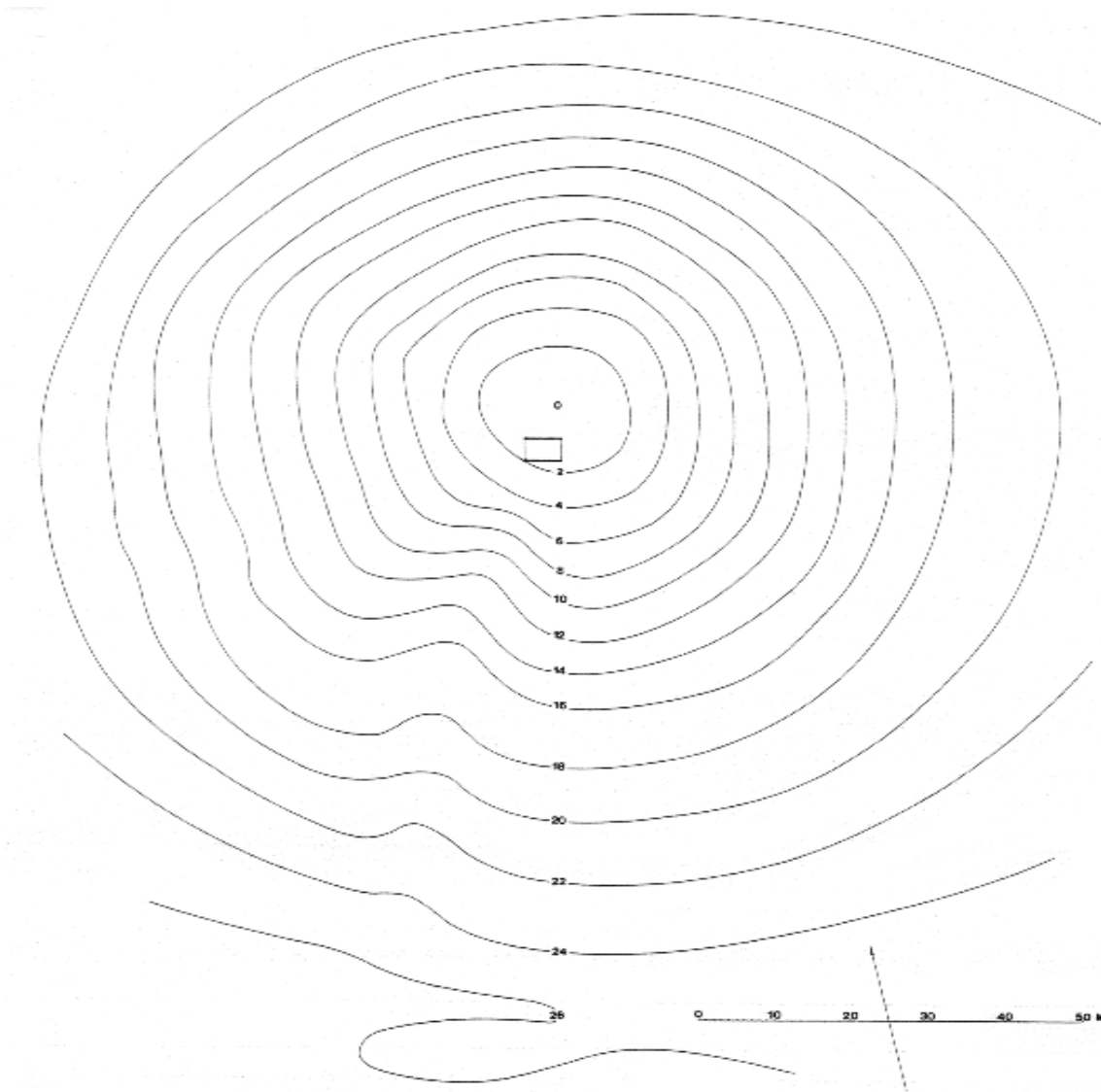

Abb.1 Tumulus W, Holzkammer, W-O Schnitt

Quelle: Young (1981) 195 Abb. 115 oben.

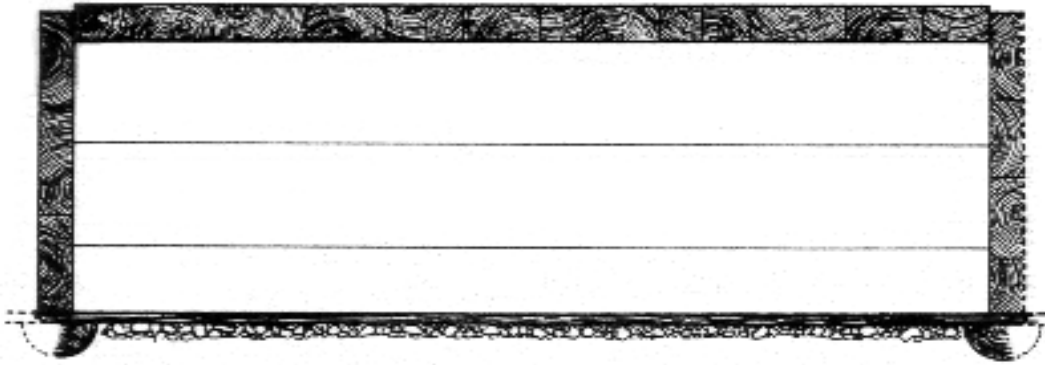

Abb. 2 Tumulus W, Holzkammer, N-S Schnitt

Quelle: Young (1981) 195 Abb. 115 Mitte.

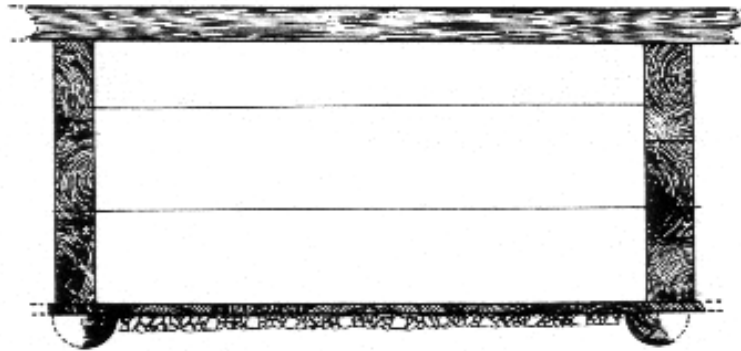

Abb.3 Tumulus W, Holzkammer, Plan

Quelle: Young (1981) 195 Abb. 115 unten.

Taf. 4

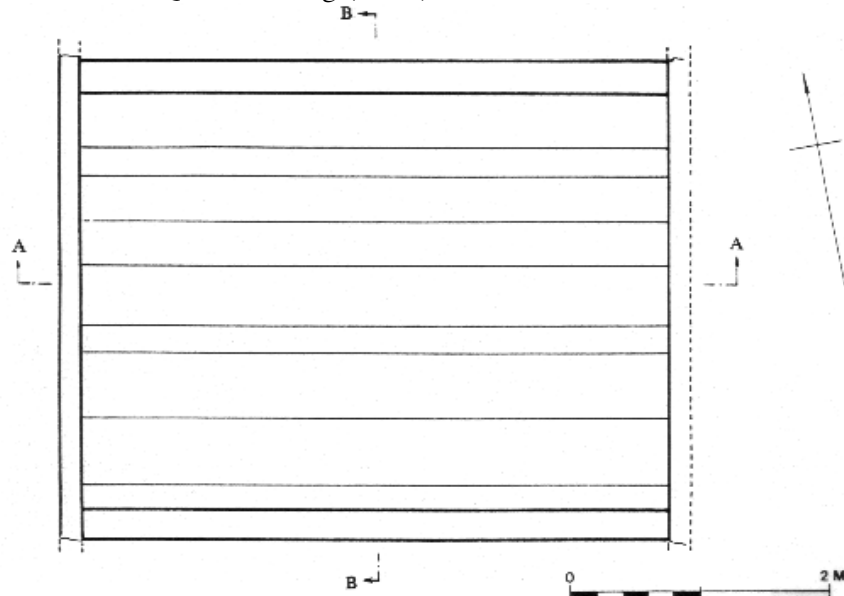

Abb.1 Tumulus G, Plan

Quelle: Kohler (1995) Abb.13 B

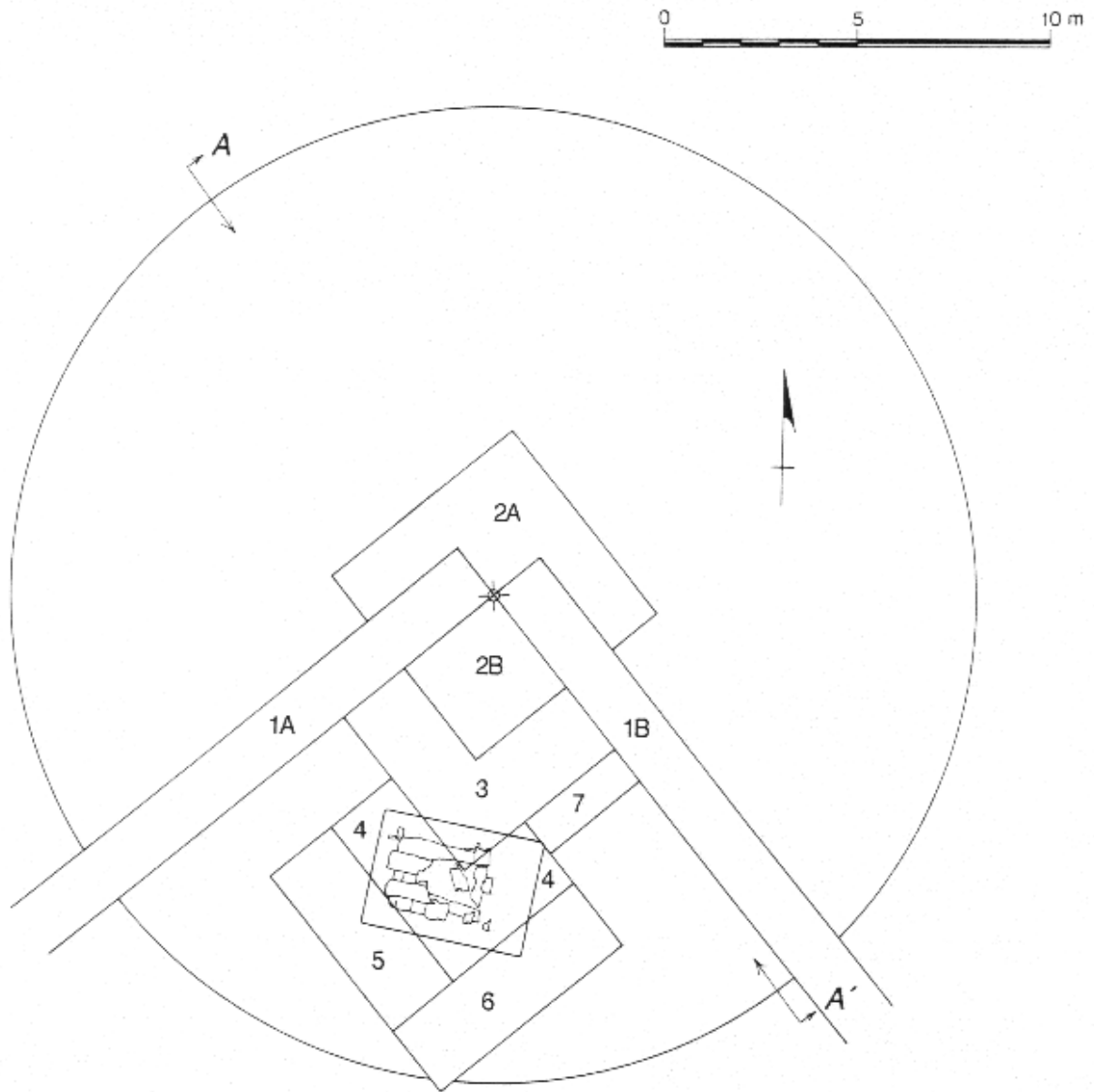

Abb.2 Tumulus G, Schnitt

Quelle: Kohler (1995) Abb. 13 A.

Taf. 5

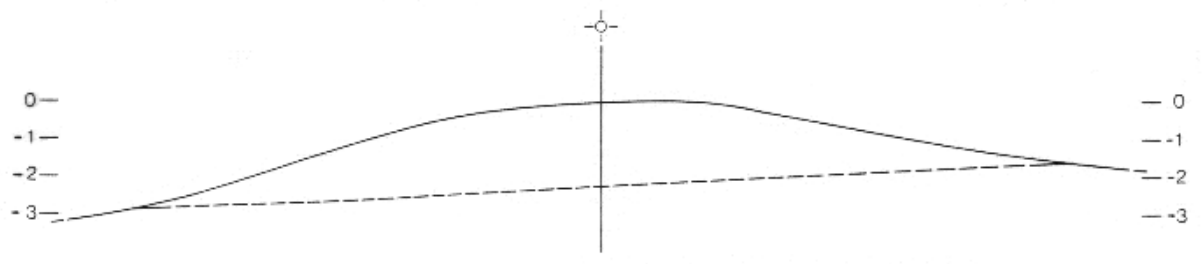

Abb.1 Tumulus G, Holzkammer, W-O Schnitt

Quelle: Kohler (1995) Abb. 15 A.

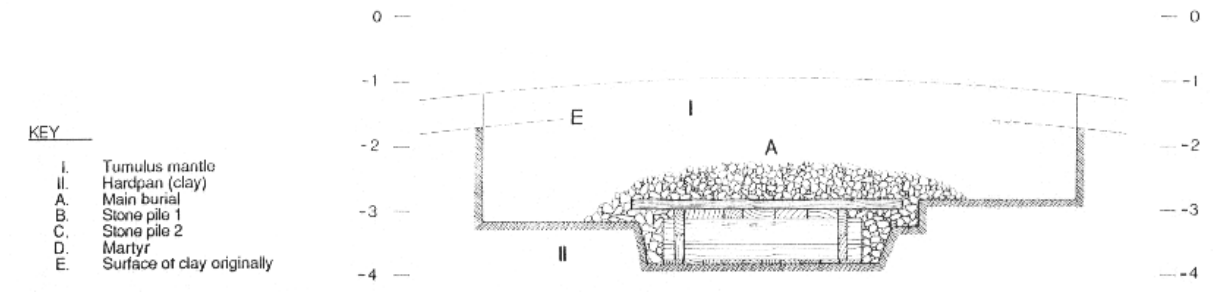

Abb.2 Tumulus G, Holzkammer, N-S Schnitt

Quelle: Kohler (1995) Abb. 15 B.

Taf. 6

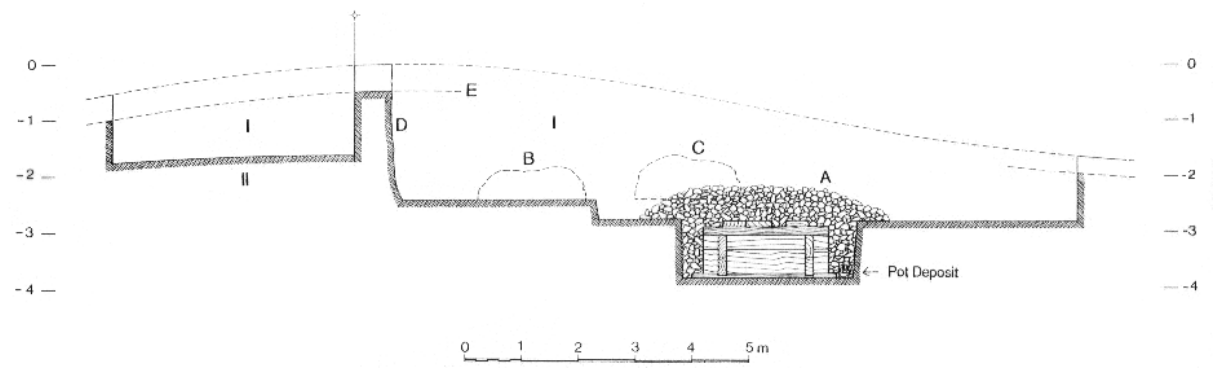

Abb.1 Tumulus P, Schnitt

Quelle: Young (1981) 5 Abb. 3 oben.

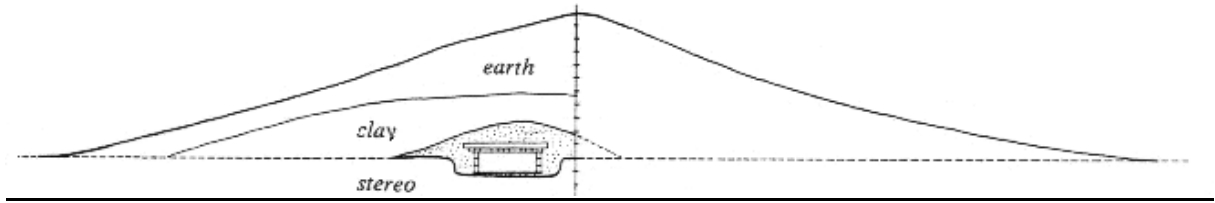

Abb.2 Tumulus P, Plan

Quelle: Young (1981) 195 Abb. 3 unten.

Taf. 7

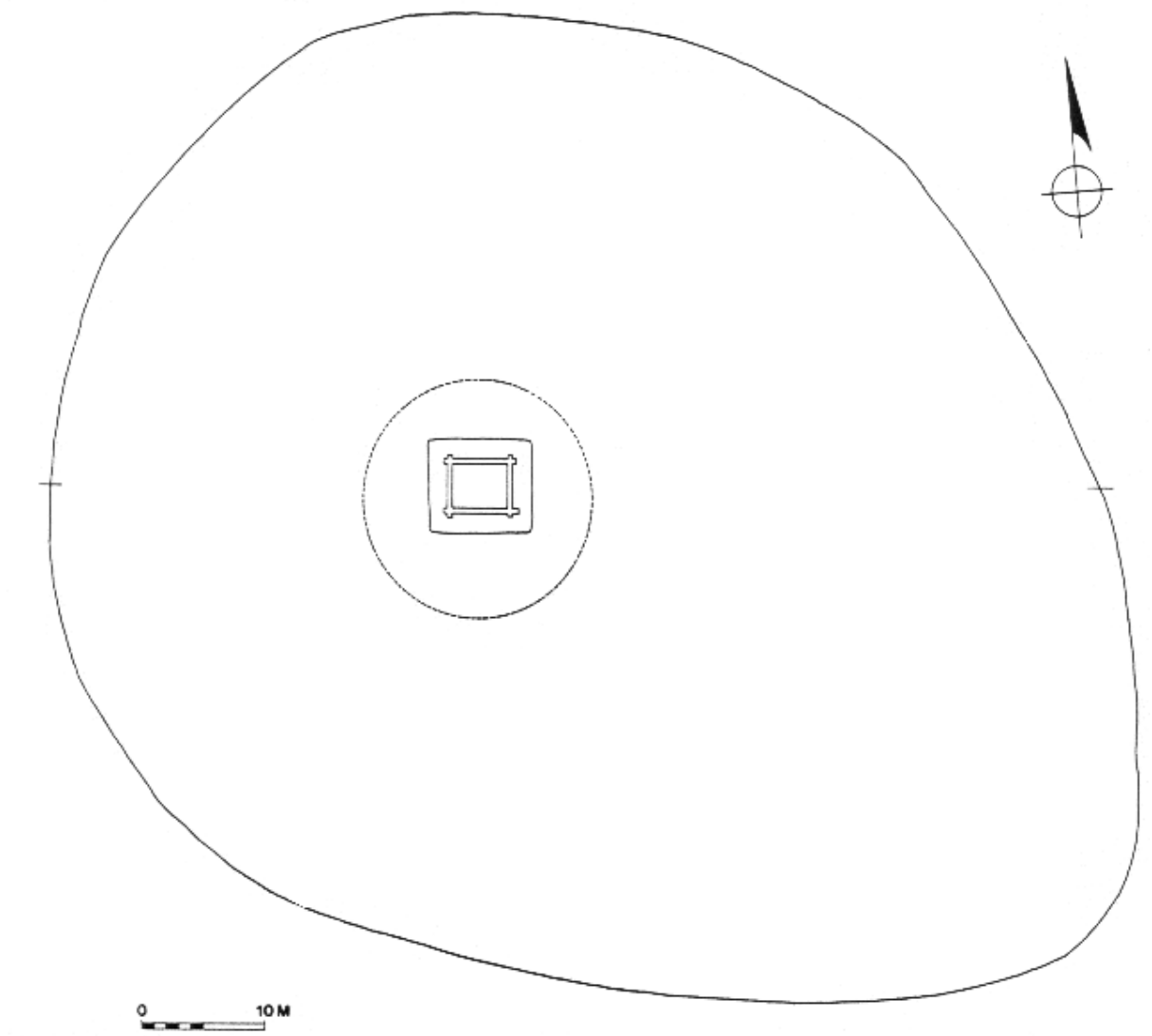

Abb.1 Tumulus P, Holzkammer, W-O Schnitt

Abb.2 Tumulus P, Holzkammer, N-S Schnitt

Abb.3 Tumulus P, Holzkammer, Plan

Abb.4 Tumulus P, Holzverbindungen

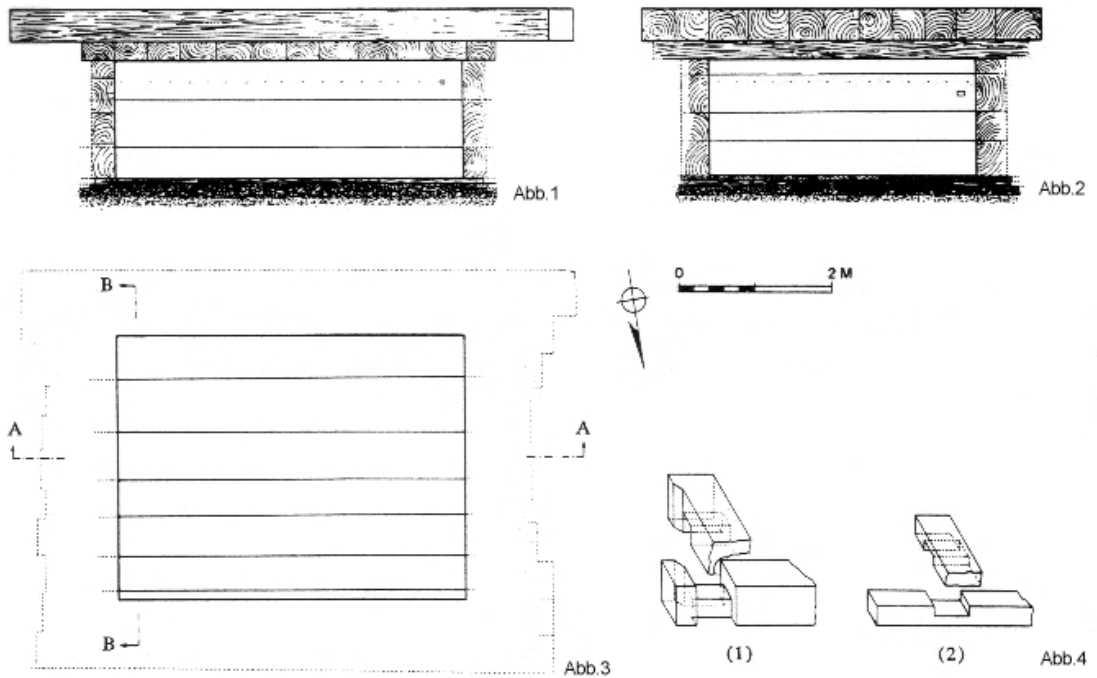
Quelle: Young (1981) 6 Abb. 4 A bis D.



Abb.5 Tumulus X, Schnitt

Quelle: Kohler (1995) Abb. 40 A.

Taf. 8.

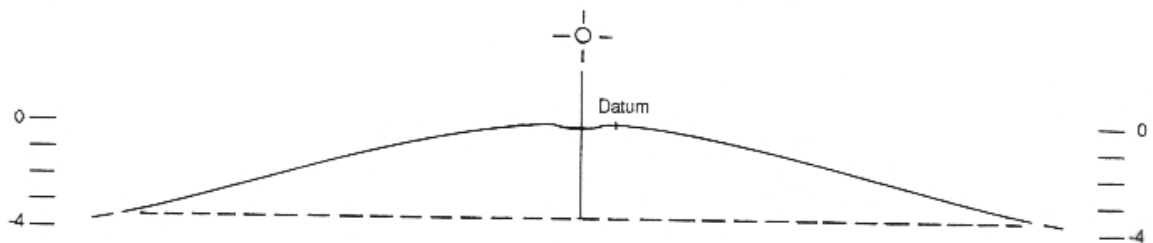

Abb.1 Tumulus X, Plan

Quelle: Kohler (1995) Abb. 40 B.

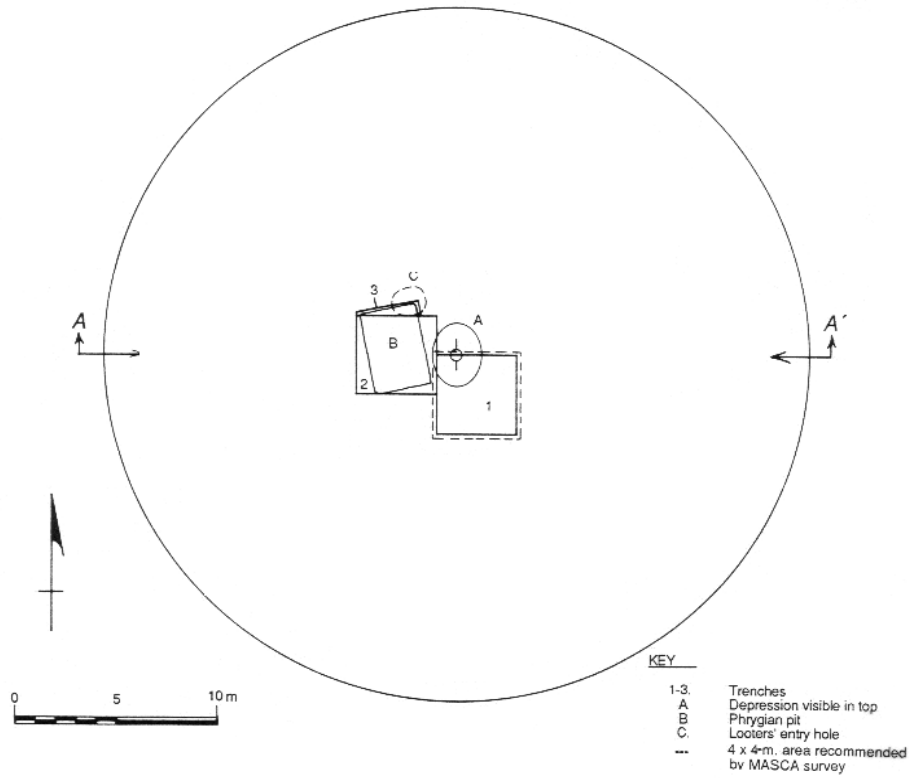

Abb.2 Tumulus X, Holzkammer, N-S Schnitt

Quelle: Kohler (1995) Abb. 41 A.

Taf. 9

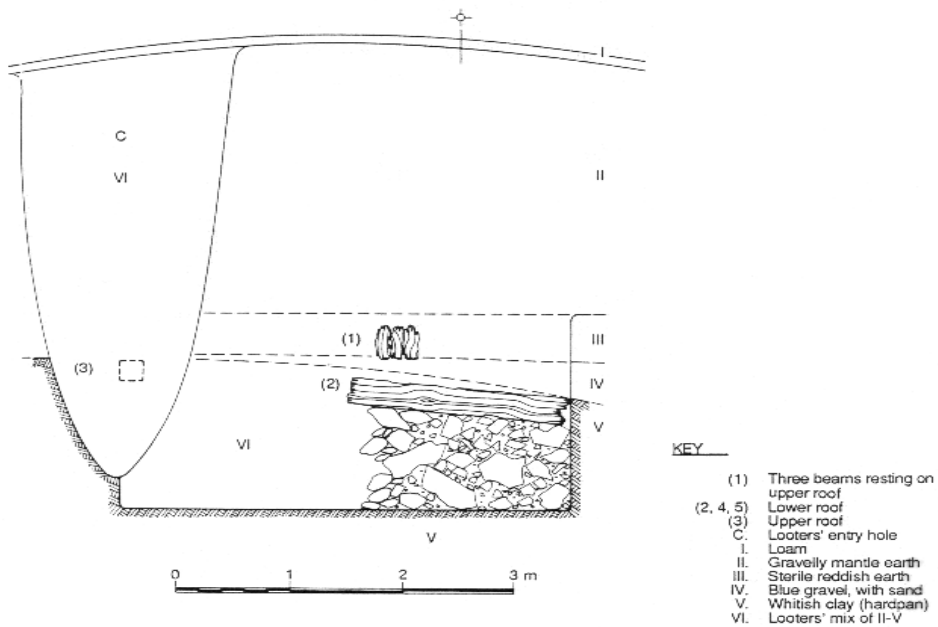

Abb.1 Tumulus X, Holzammer

Quelle: Kohler (1995) Abb. 41 B.

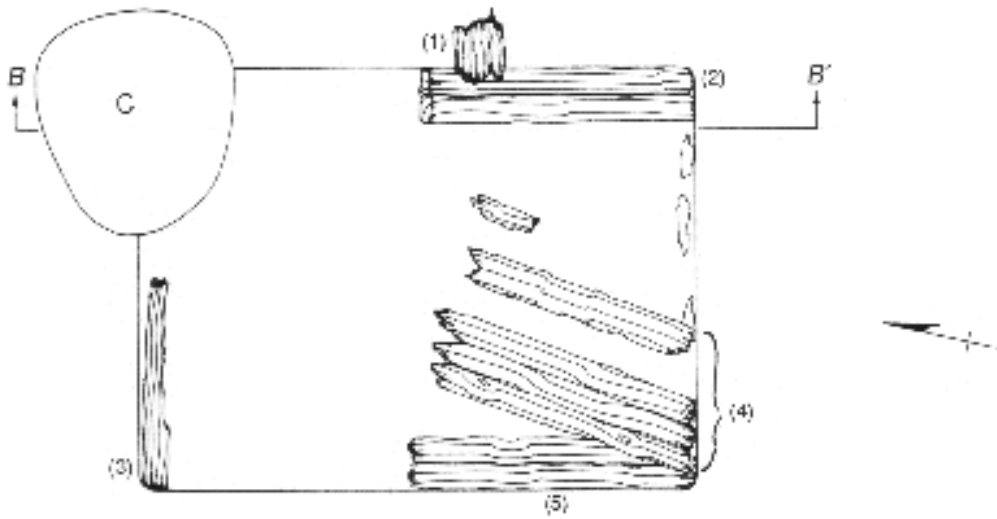

Abb.2 Tumulus Y

Quelle: Kohler (1995) Abb. 43 B.

Taf. 10

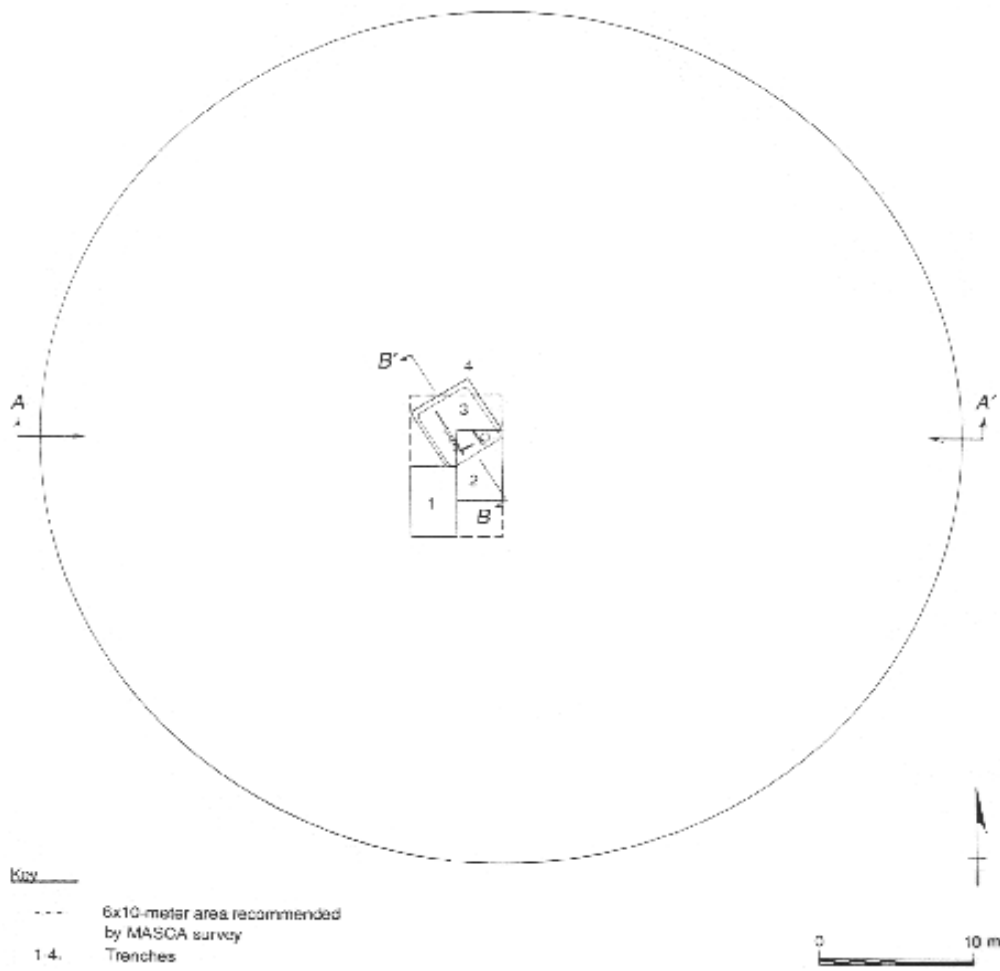

Abb.1 Tumulus Y, Schnitt

Quelle: Kohler (1995) Abb. 43 A.

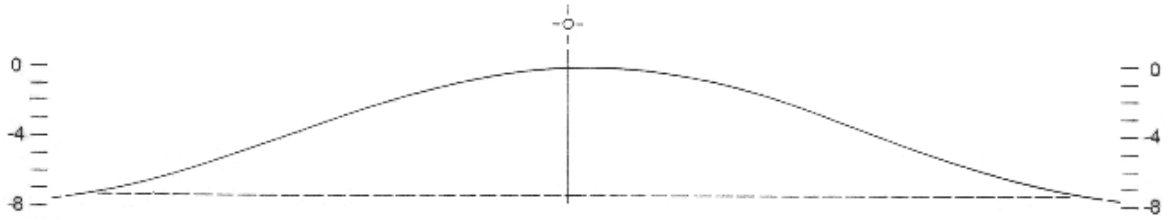

Abb.2 Tumulus Y, Holzkammer, N-S Schnitt

Quelle: Kohler (1995) Abb. 44 A.

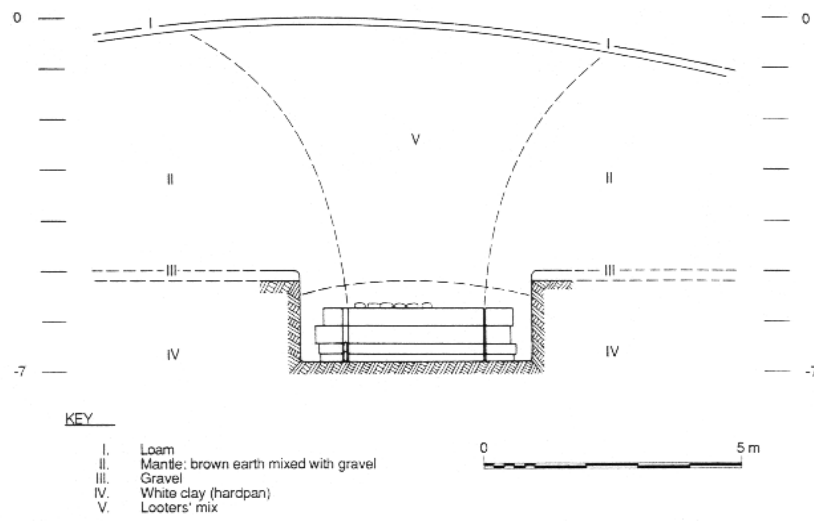

Abb.3 Tumulus Y, Holzkammer

Quelle: Kohler (1995) Abb. 44 B.

Taf. 11

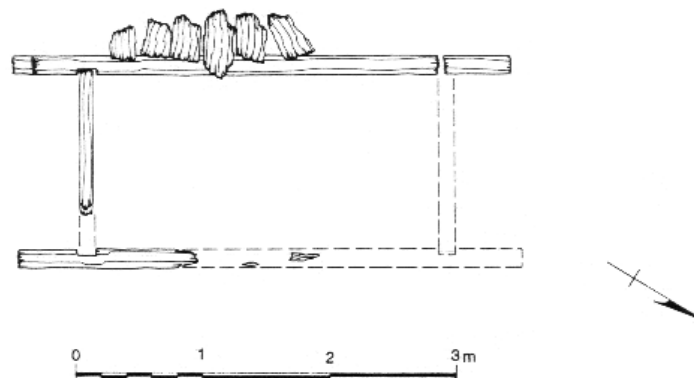

Abb.1 Tumulus MM, Plan

Quelle: Young (1981) 82 Abb. 50.

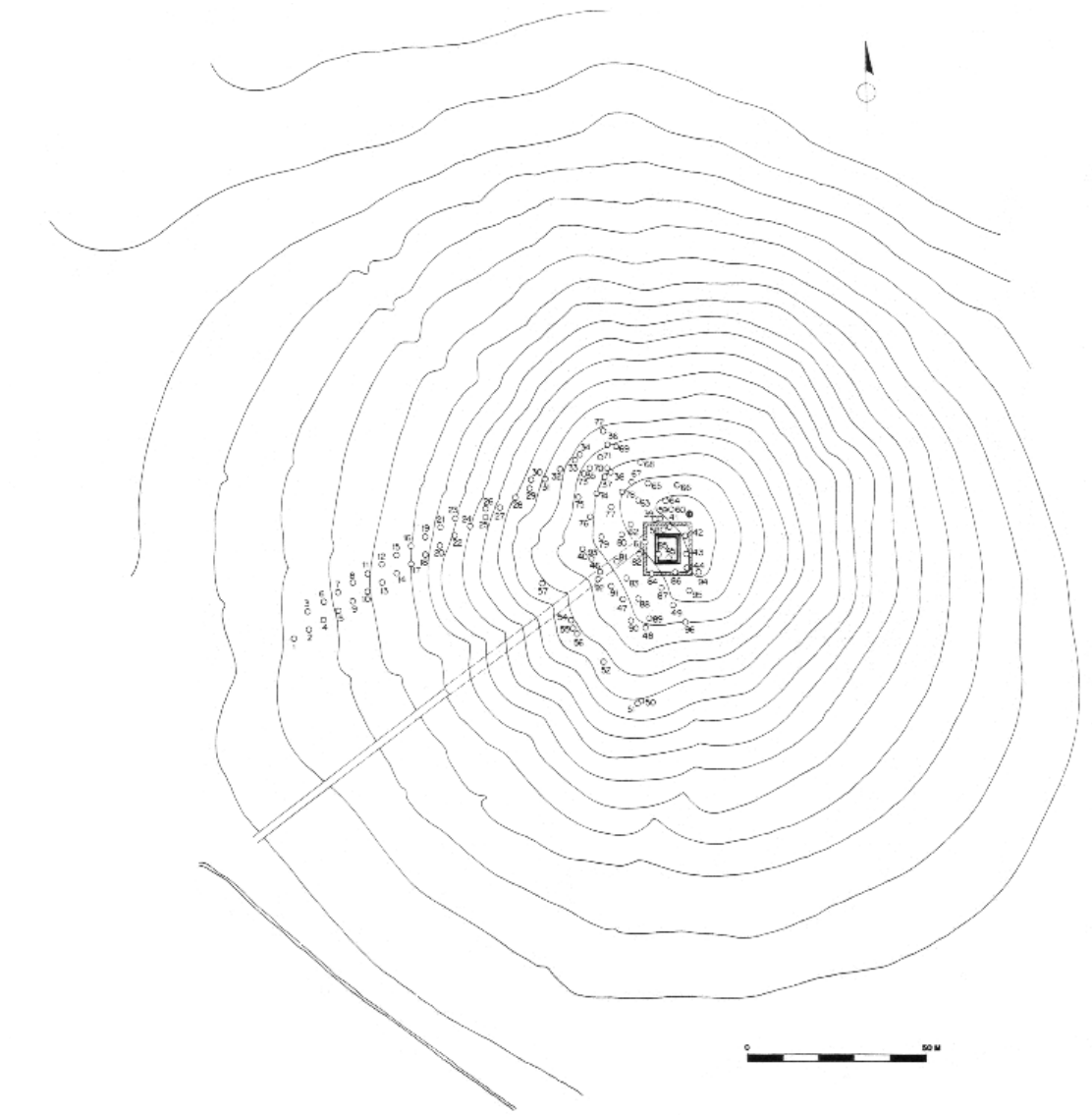

Abb.2 Tumulus MM, Schnitt

Quelle: Young (1981) 83 Abb. 51.

Taf. 12

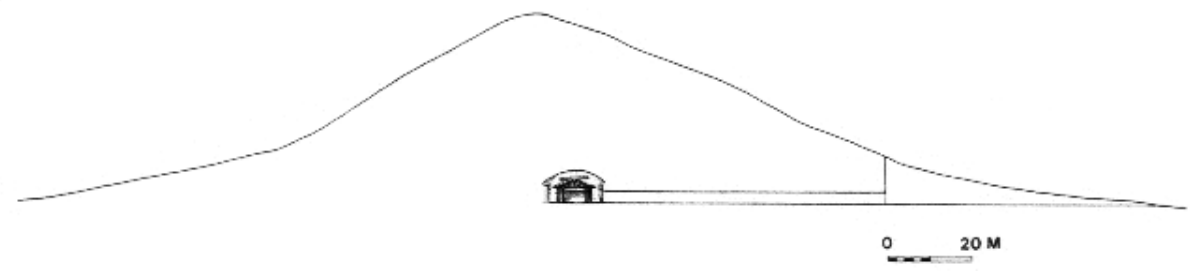

Abb.1 Tumulus MM, Holzkammer

Quelle: Young (1981) 93 Abb. 61.

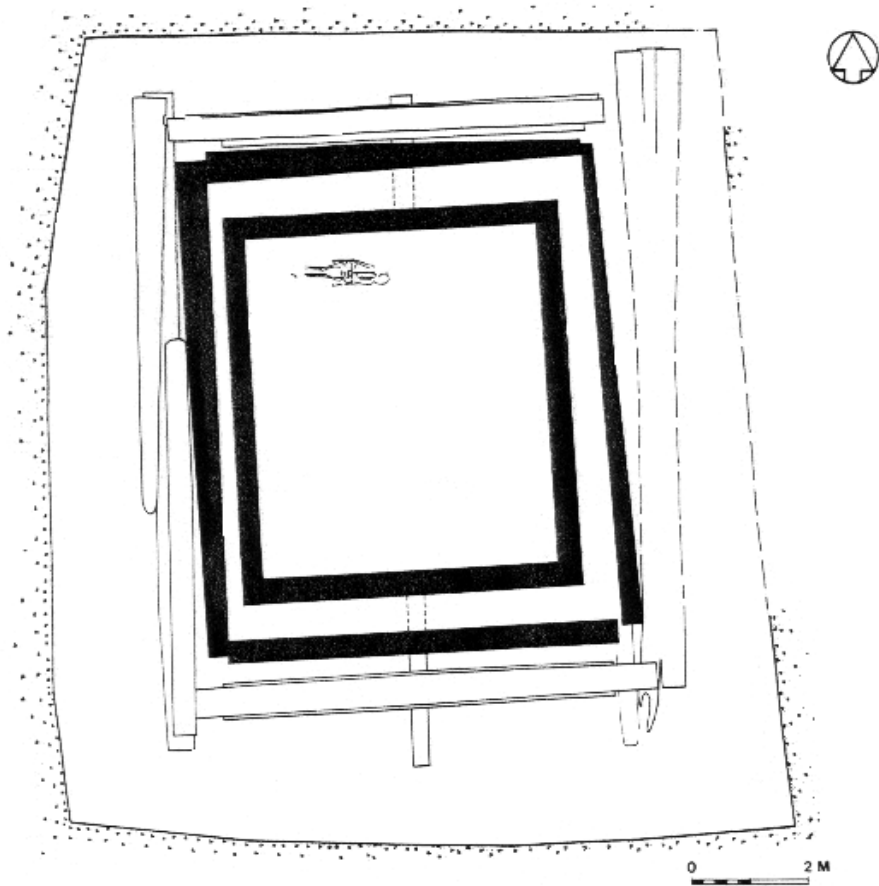

Abb.2 Tumulus MM, Holzkammer, W-O Schnitt

Quelle: Young (1981) 93 Abb.62

Taf. 13

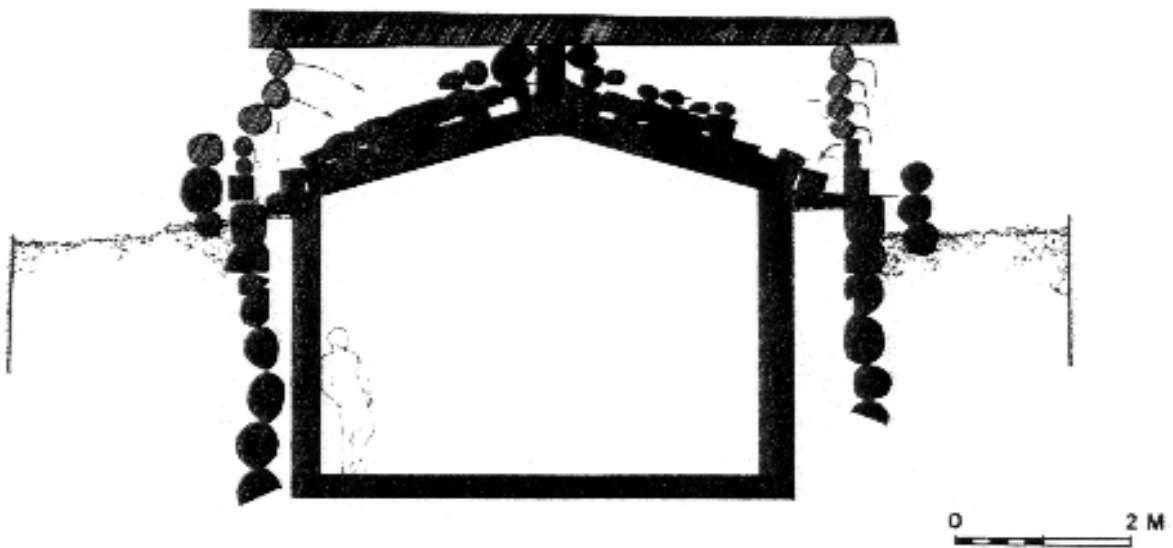

Abb.1 Tumulus KY, Plan

Quelle: Kohler (1995) Abb. 28 B.

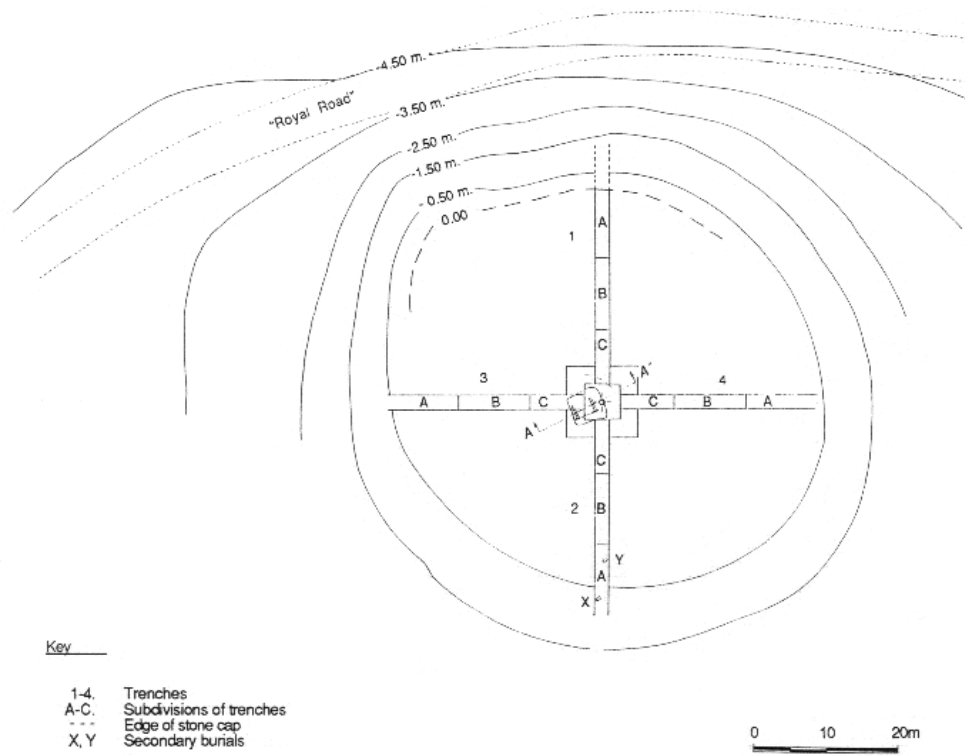

Abb.2 Tumulus KY, Schnitt

Quelle: Kohler (1995) Abb. 28 A.

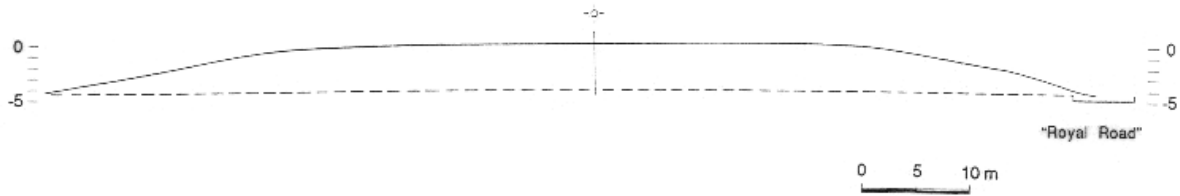

Abb.3 Tumulus KY, Holzkammer, W-O Schnitt

Quelle: Kohler (1995) Abb. 29 A.

Taf. 14

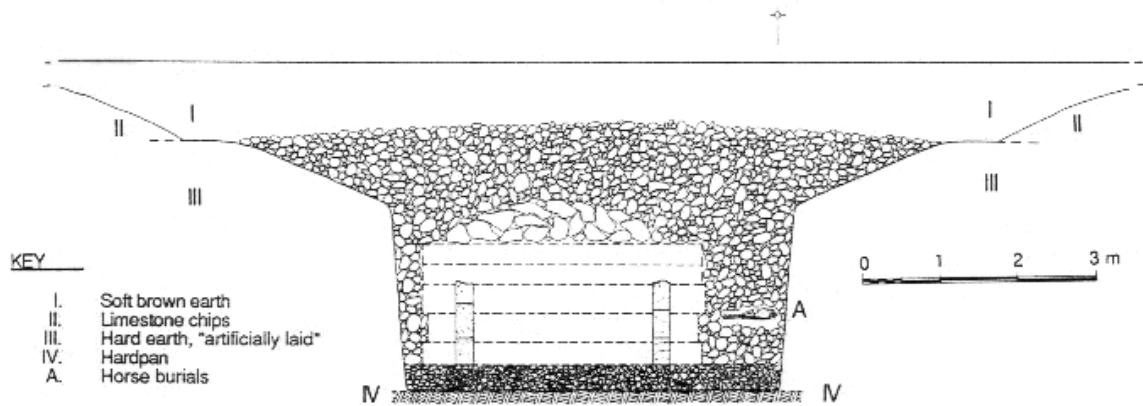

Abb.1 Tumulus KY, Holzkammer und Grube

Quelle: Kohler (1995) Abb. 29 B.

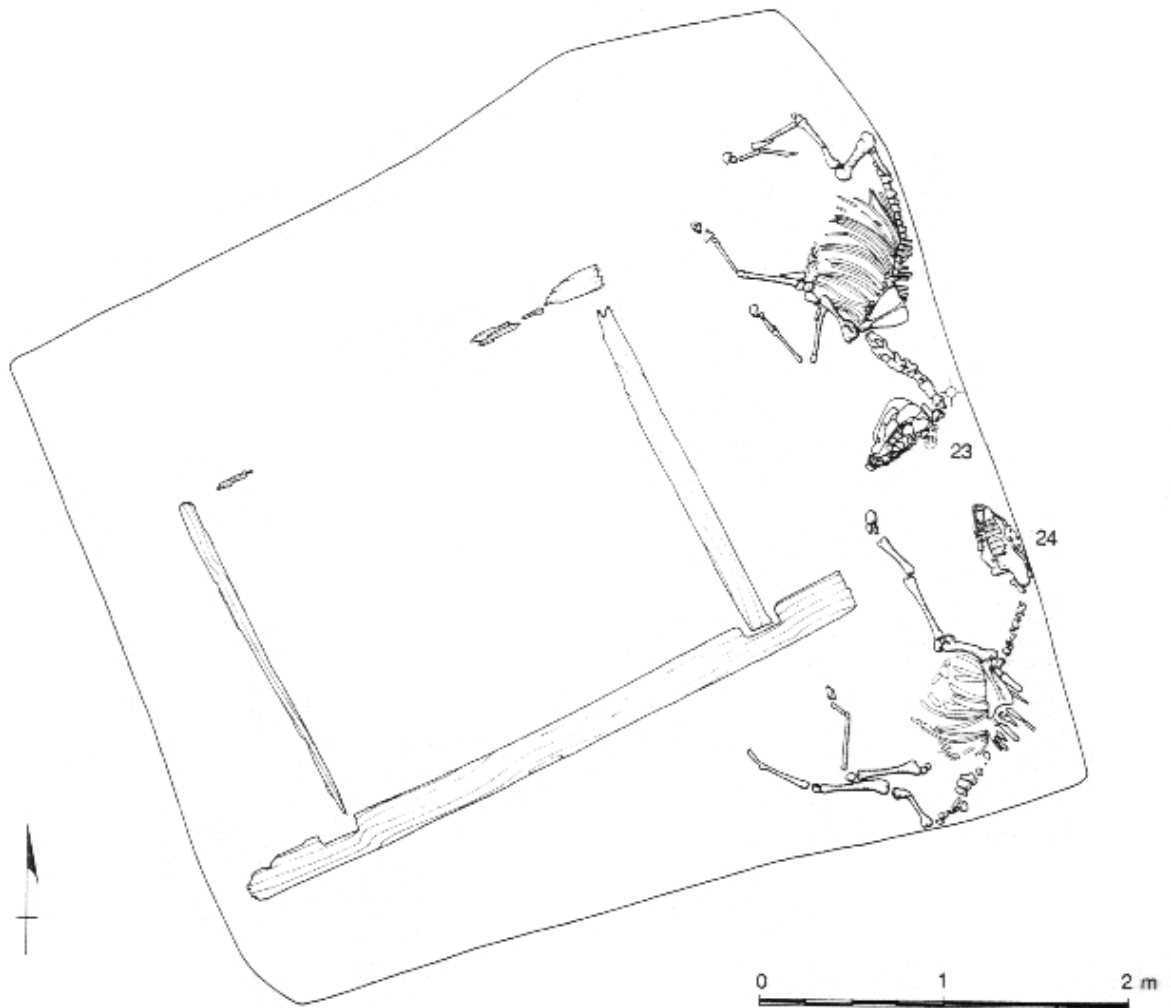

Abb.2 Tumulus S1, Schnitt

Quelle: Kohler (1995) Abb. 47 A.

Taf. 15

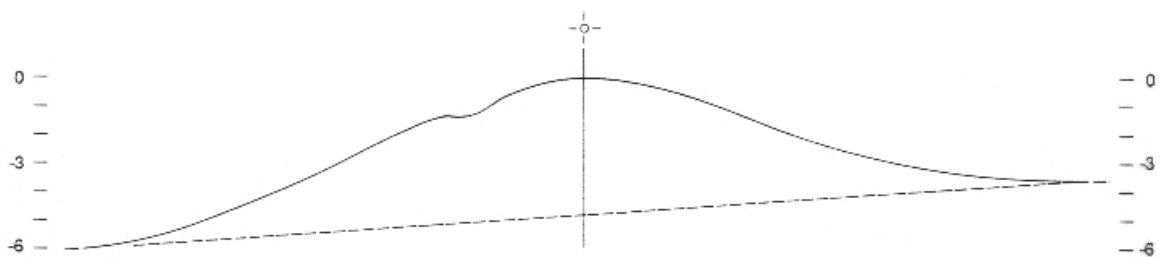

Abb.1 Tumulus S1, Plan

Quelle: Kohler (1995) Abb. 47 B.

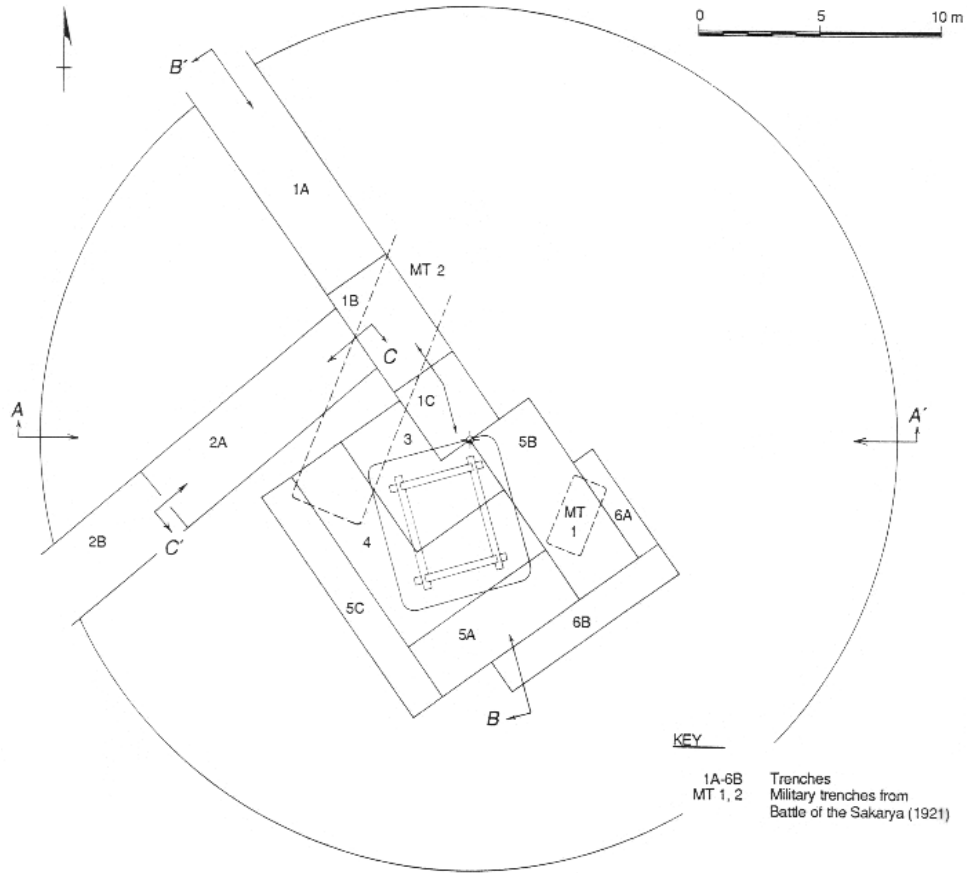

Abb.2 Tumulus S1, Holzkammer

Quelle: Kohler (1995) Abb. 48 A.

Taf. 16

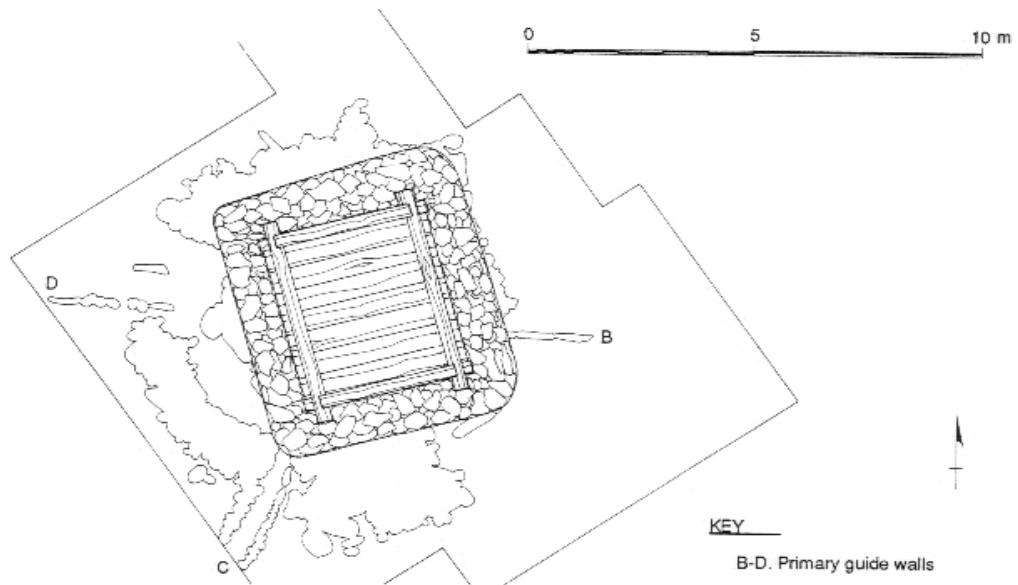

Abb.1 Tumulus S1, Holzkammer, N-S Schnitt

Quelle: Kohler (1995) Abb. 49 A.

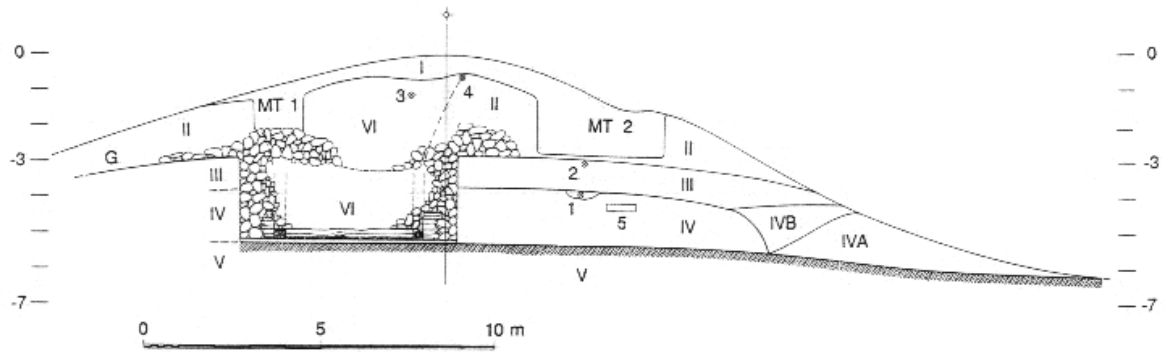

Abb.2 Tumulus Z, Plan

Quelle: Kohler (1995) Abb. 63 B.

Taf. 17

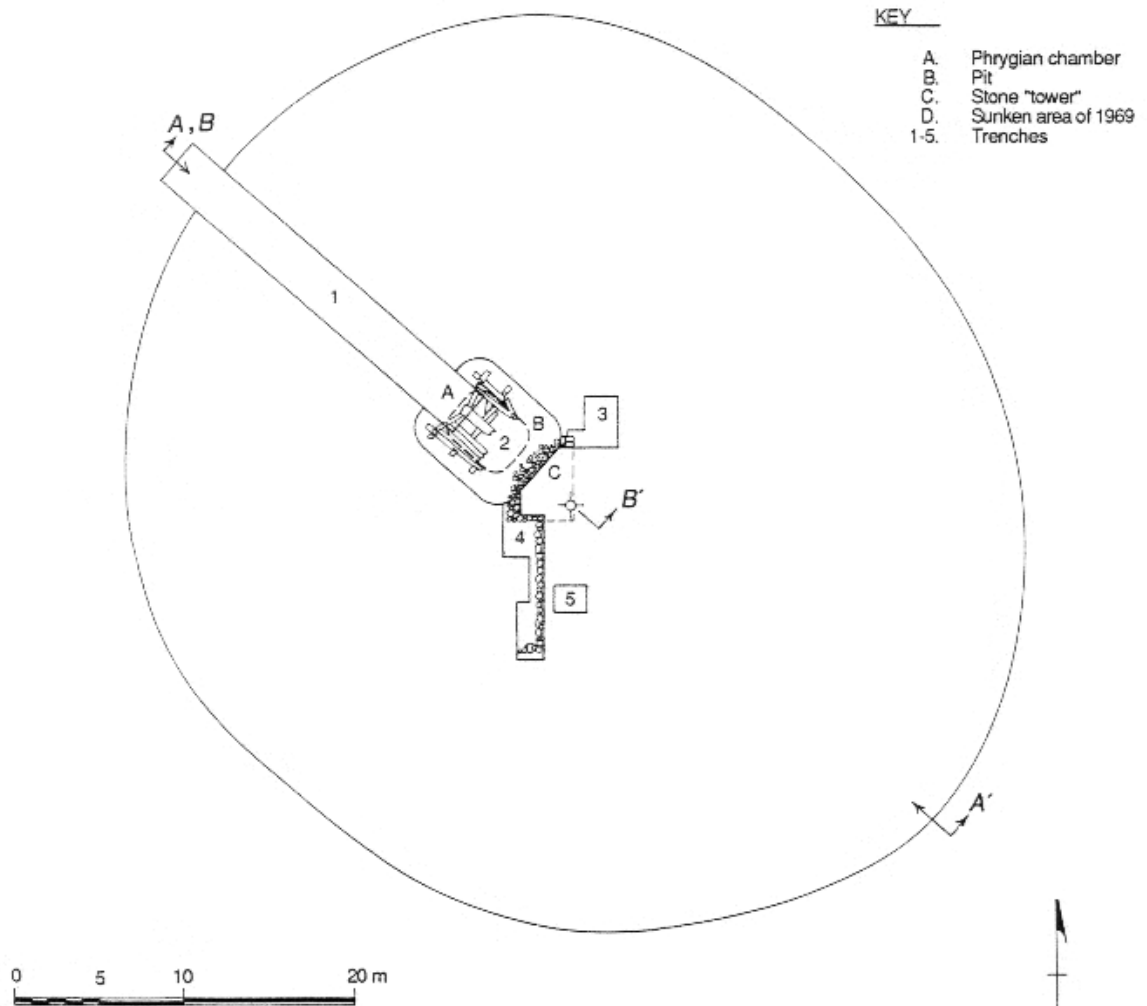

Abb.1 Tumulus Z, Holzammer, NW-SO Schnitt

Quelle: Kohler (1995) Abb. 64.

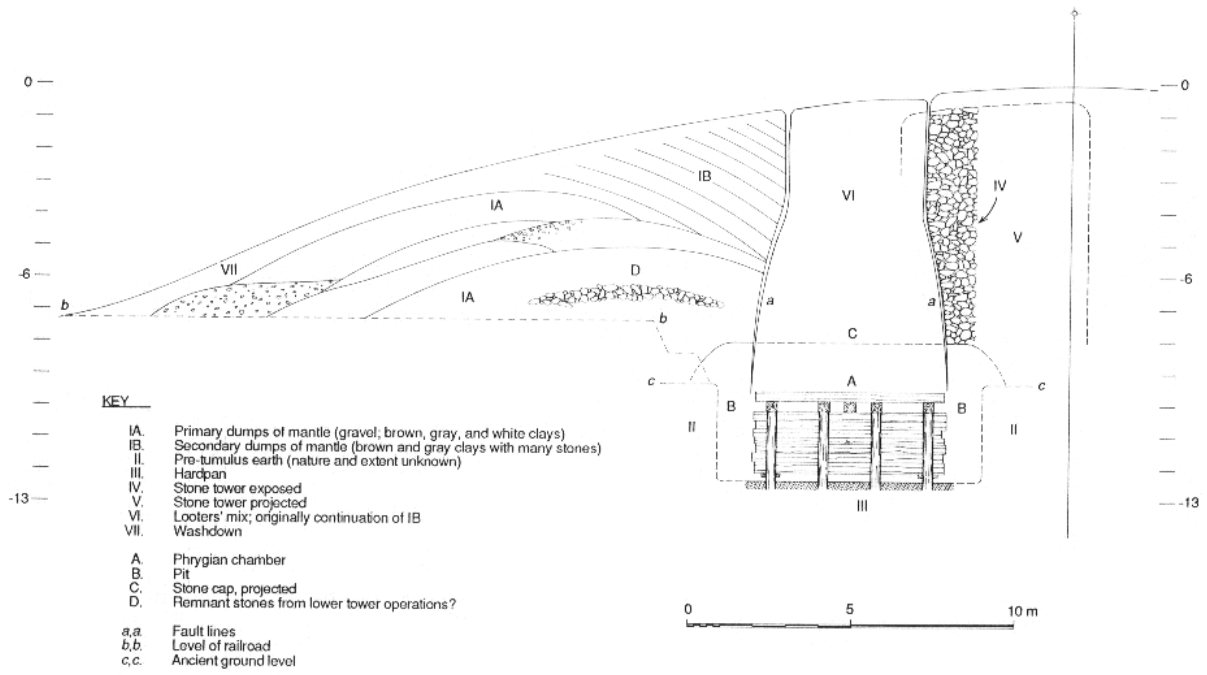

Abb.2 Tumulus N, Plan

Quelle: Kohler (1995) Abb. 33 B.

Taf. 18

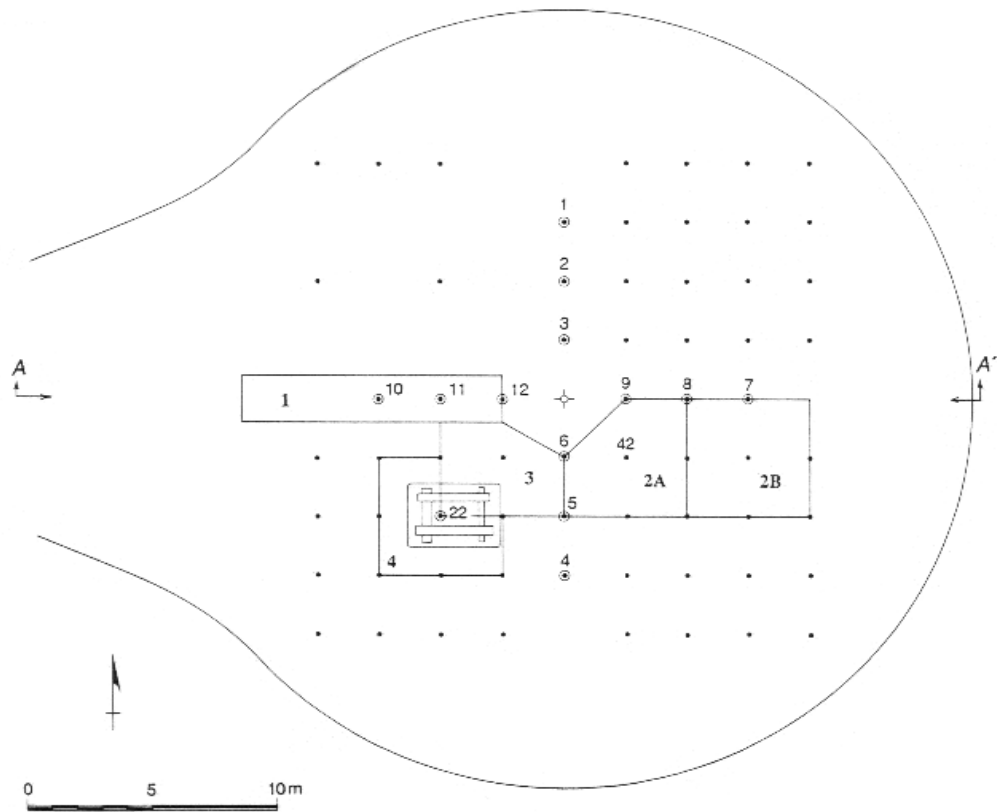

Abb.1 Tumulus N, Schnitt

Quelle: Kohler (1995) Abb. 33 A.

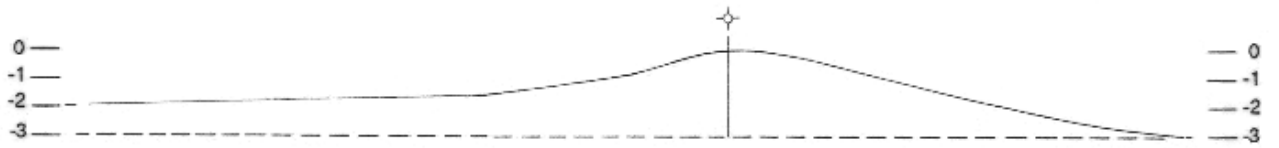

Abb.2 Tumulus N, Holzkammer, W-O Schnitt

Quelle: Kohler (1995) Abb. 34 A.

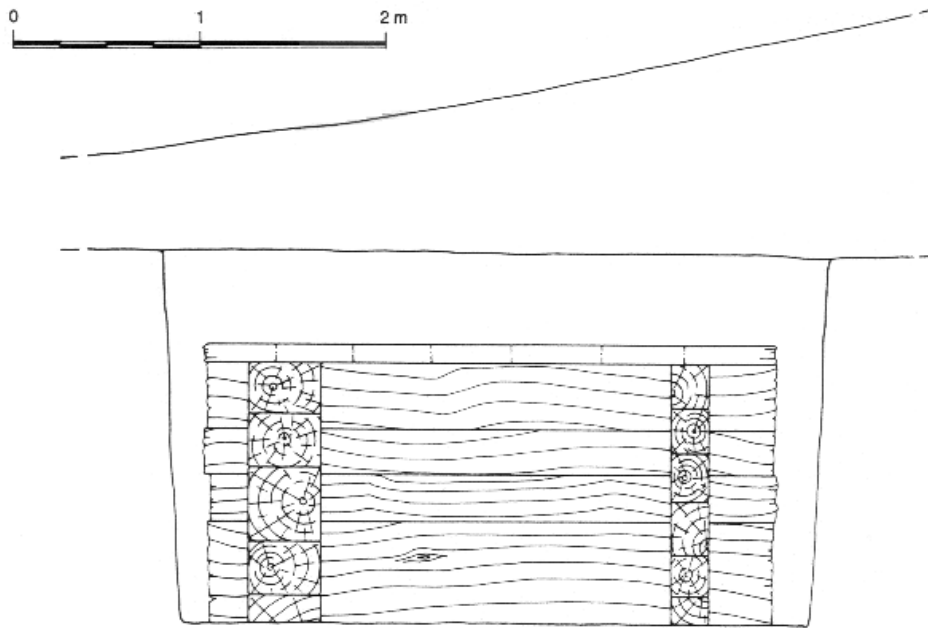

Abb.3 Tumulus H, Holzkammer, N-S Schnitt

Quelle: Kohler (1995) Abb. 20 A.

Taf. 19

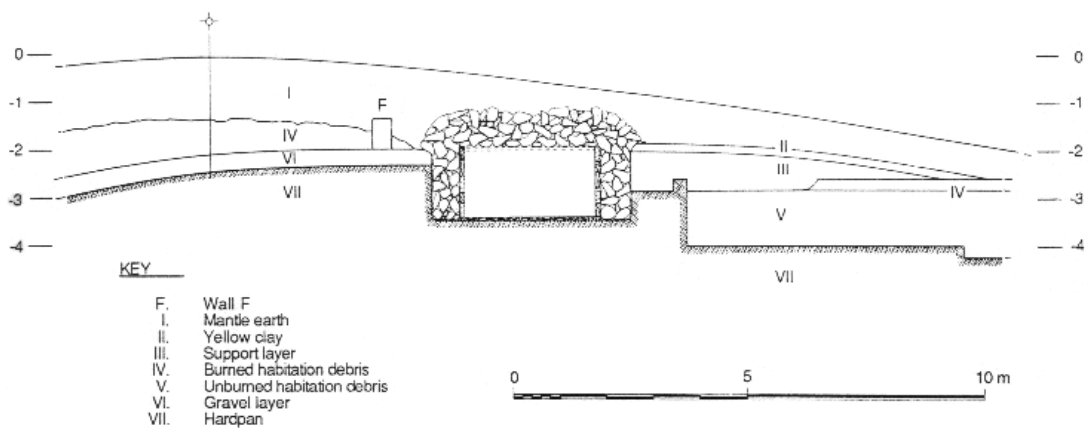

Abb.1 Tumulus B, Schnitt

Quelle: Kohler (1995) Abb. 3 A.

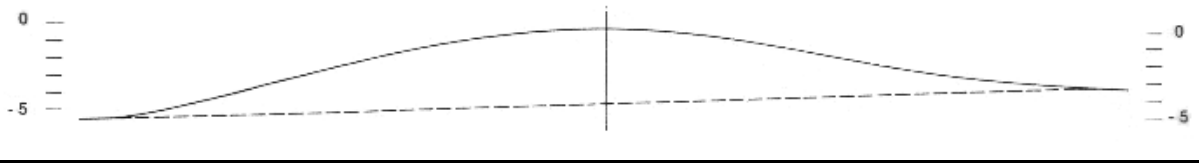

Abb.2 Tumulus B

Quelle: Kohler (1995) Abb. 3 B.

Taf. 20

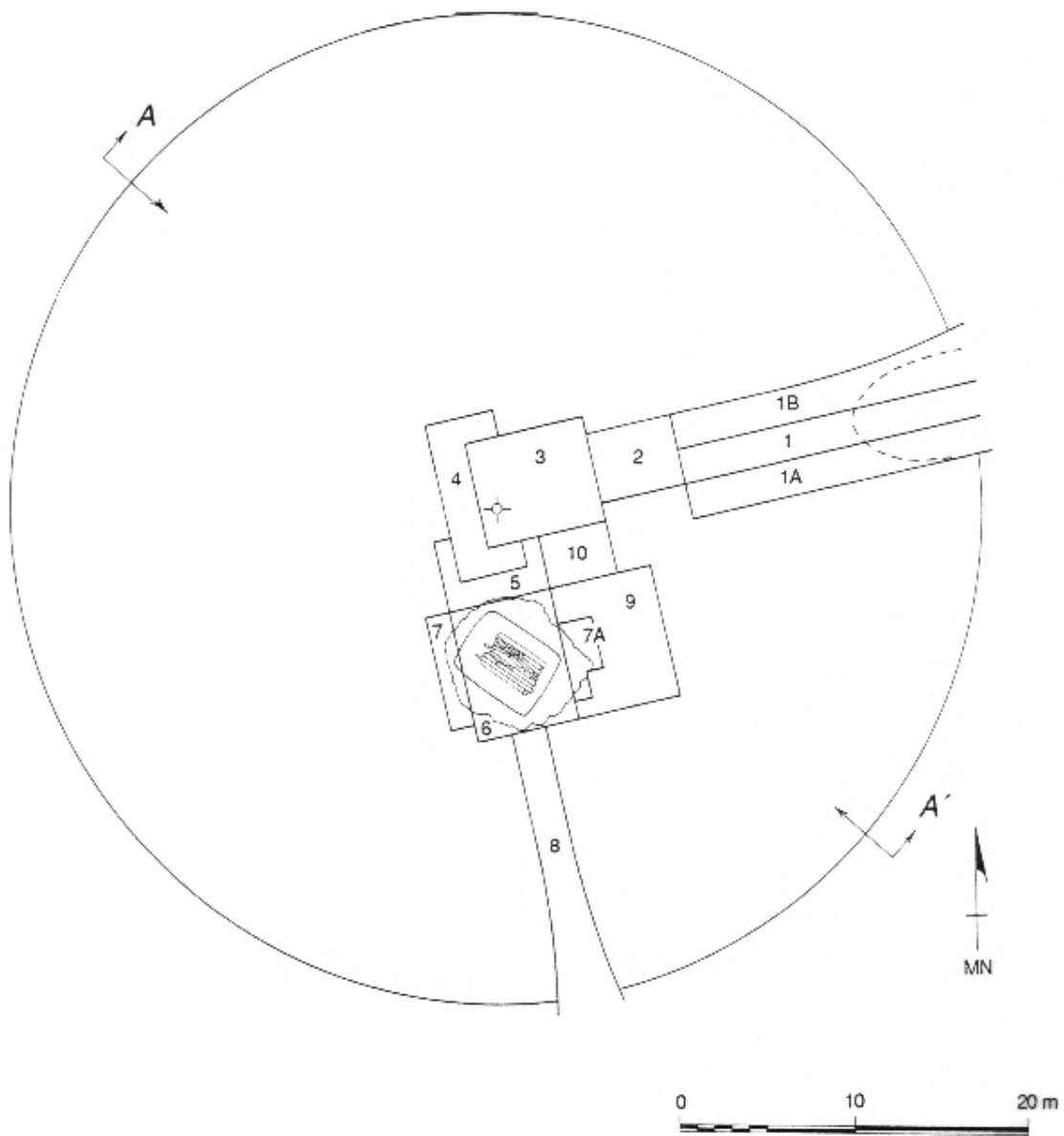

Abb.1 Tumulus B, Holzammer

Quelle: Kohler (1995) Abb. 6 B.

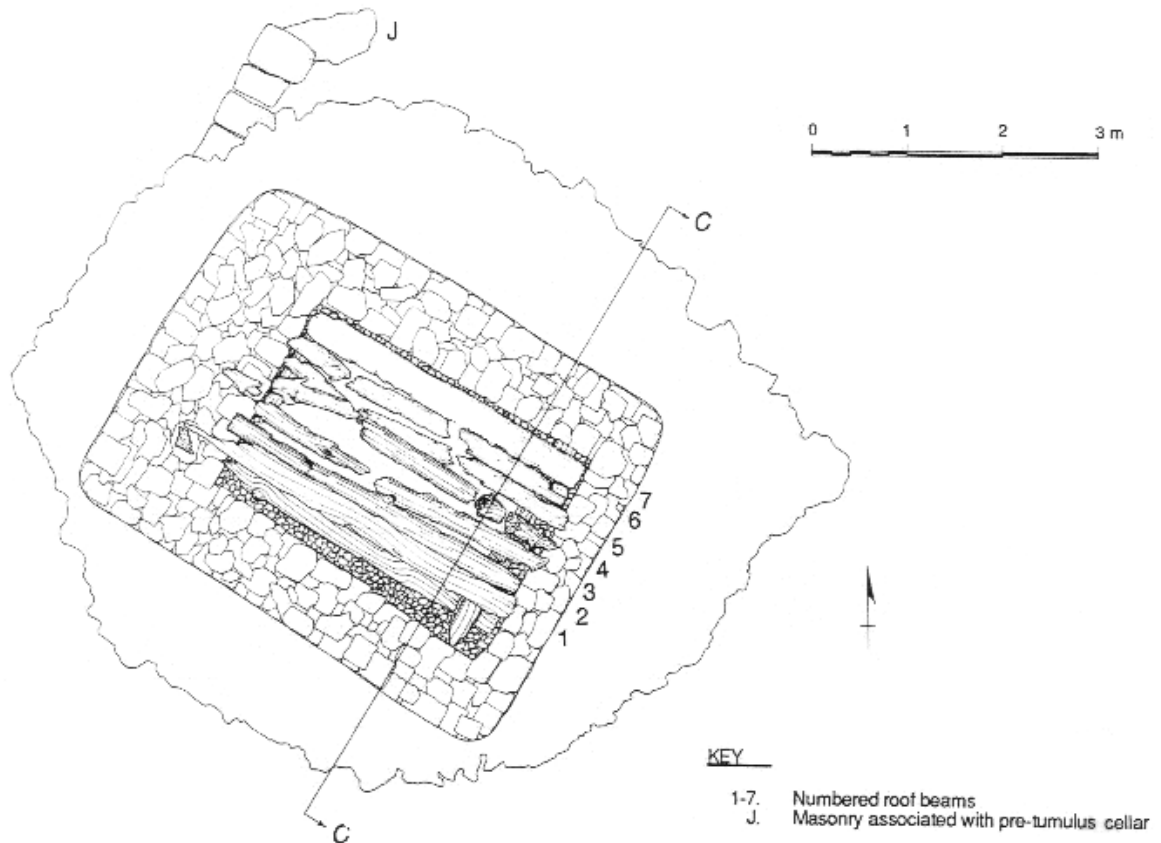

Abb.2 Tumulus N, Holzammer, N-S Schnitt

Quelle: Kohler (1995) Abb. 6 A.

Taf. 21

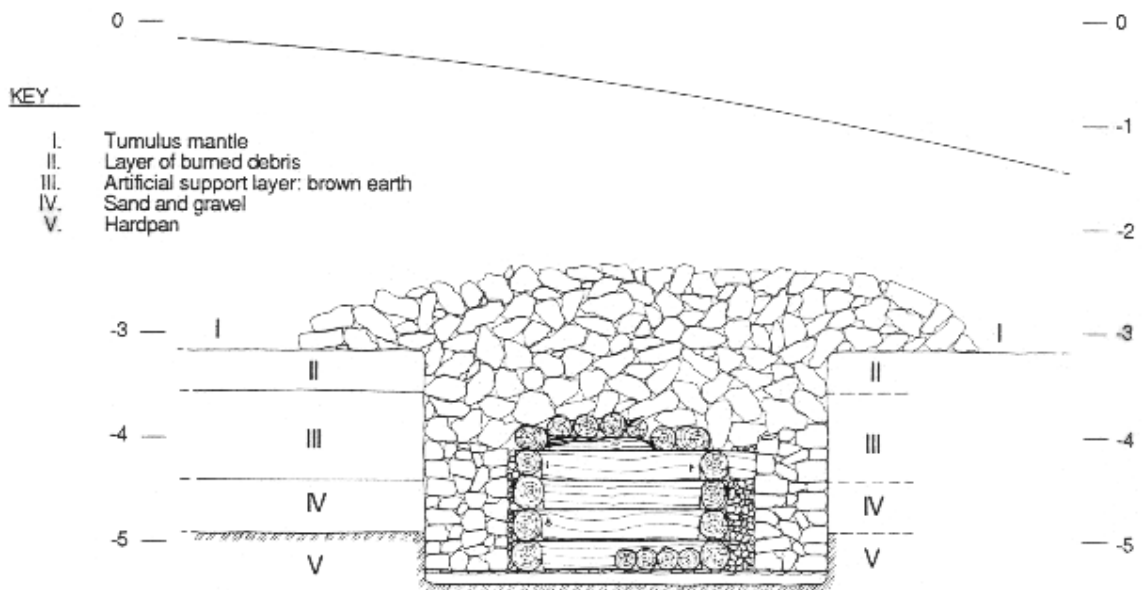

Abb.1 Tumulus F

Quelle: DeVries, FS Young, 1980, 73 Abb. 4.

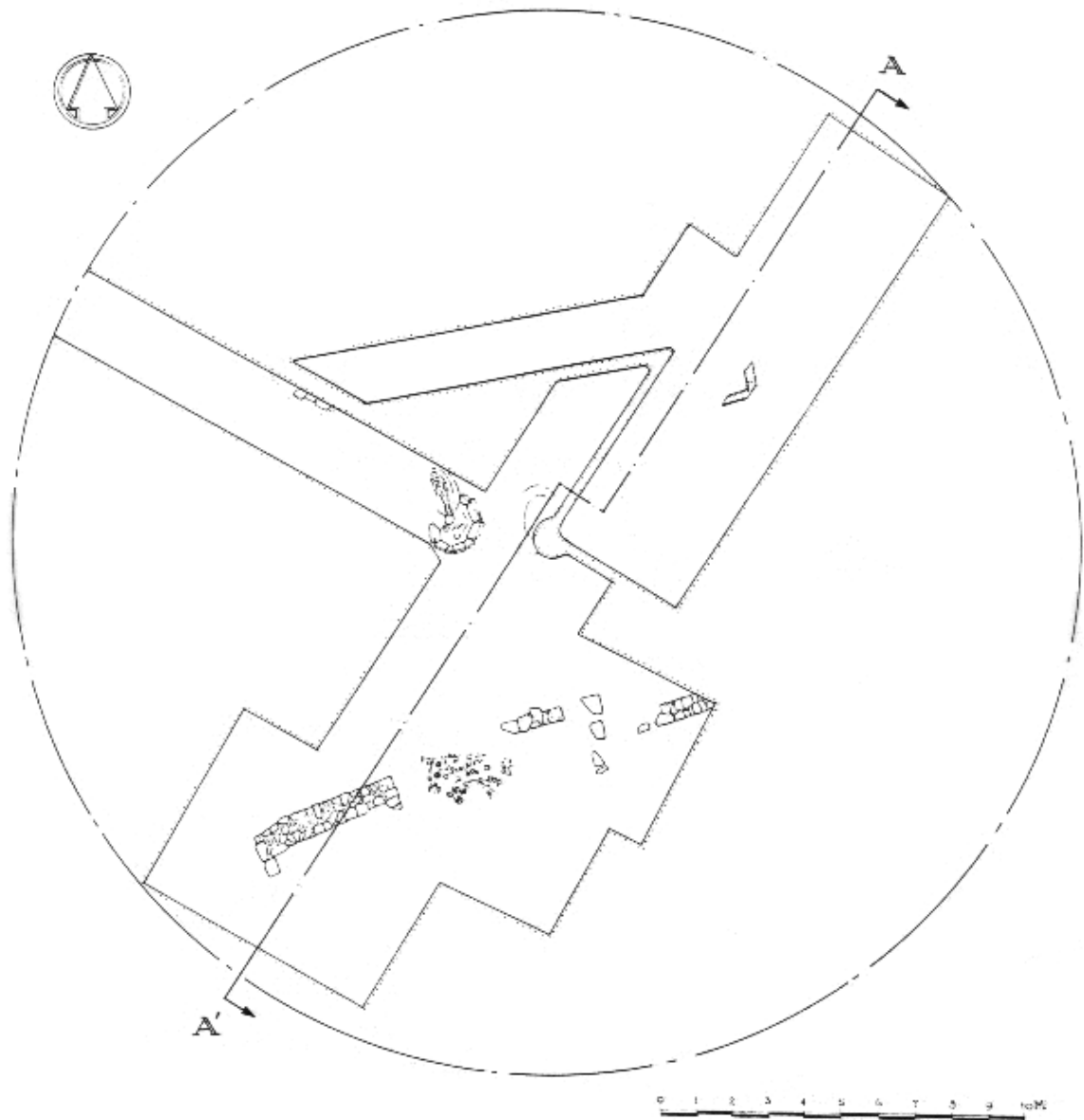

Abb.2 Tumulus F, Schnitt

Quelle: DeVries, FS Young, 1980, 73 Abb. 3.

Taf. 22

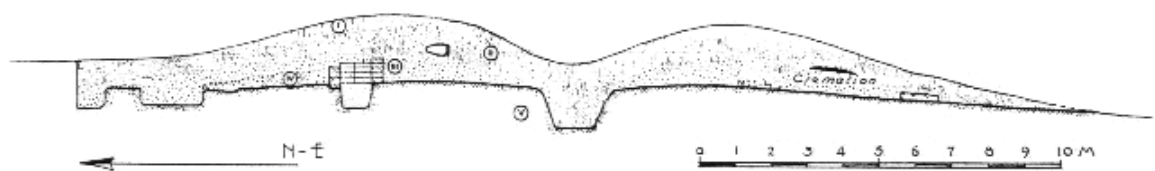

Abb.1 Tumulus J

Quelle: Kohler (1995) Abb. 23.

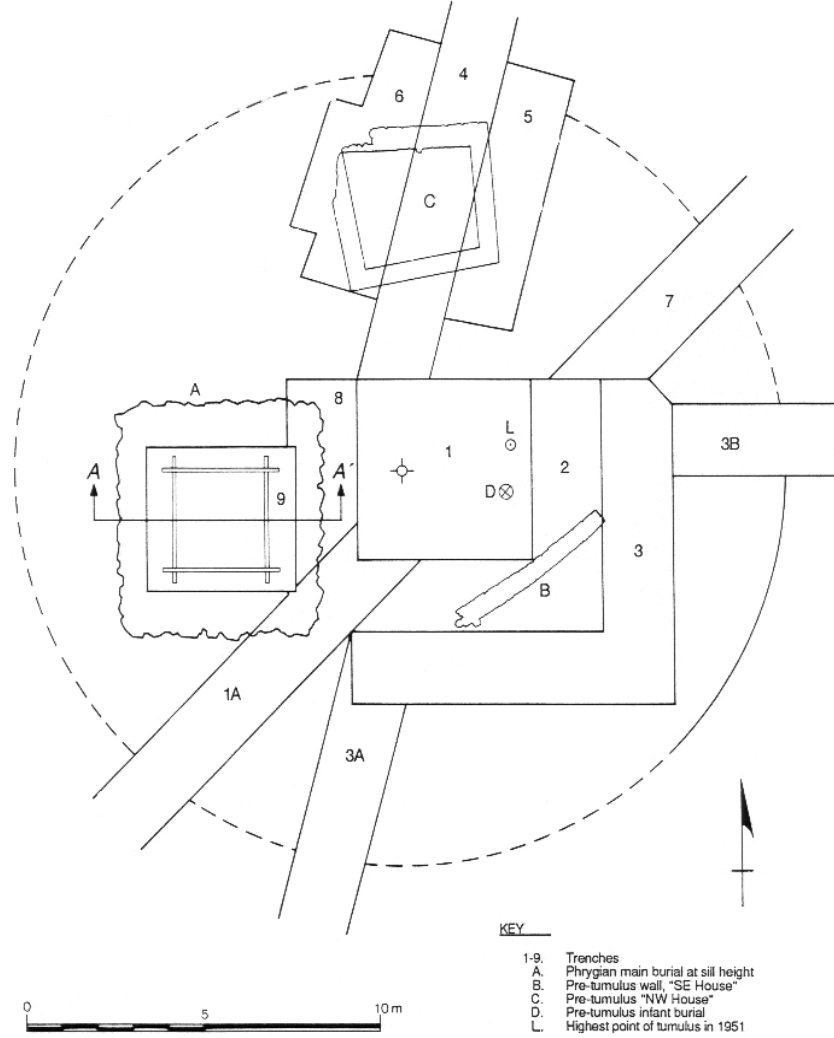

Abb.2 Tumulus J, Holzkammer, Schnitt

Quelle: Kohler (1995) Abb.24 A

Taf. 23

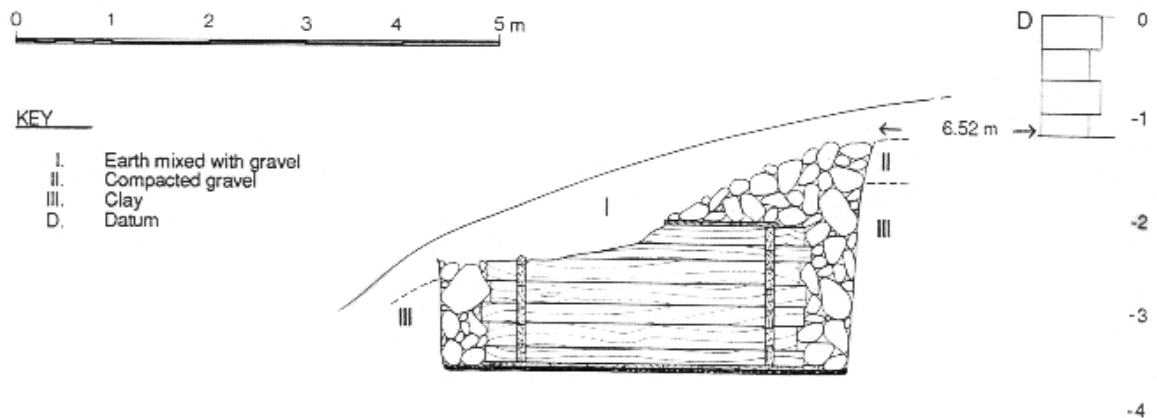

Abb.1 Tumulus M

Quelle: DeVries, FS Young, 1980, 79 Abb. 15.

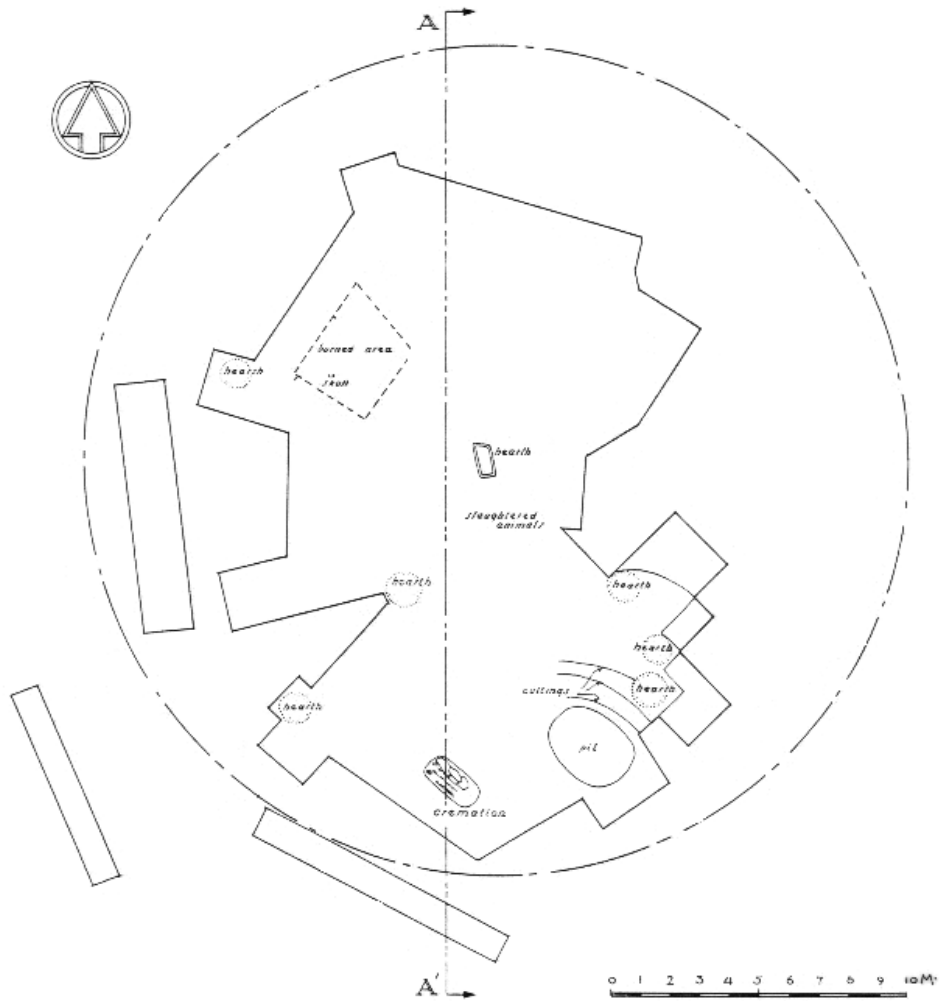

Abb.2 Tumulus M, Schnitt

Quelle: DeVries, FS Young, 1980, 79 Abb. 14.

Taf. 24

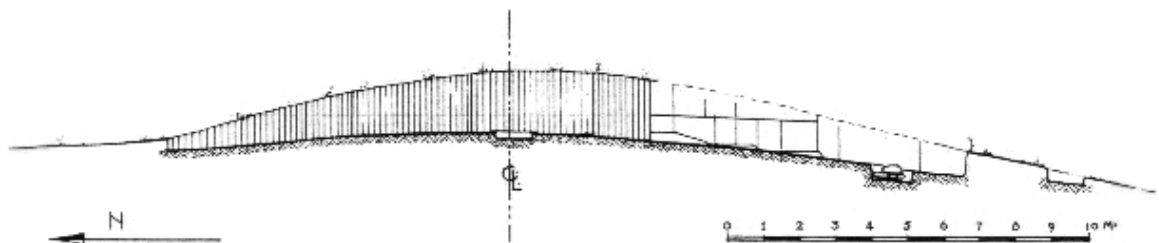

Abb.1 Tumulus C, Plan

Quelle: Kohler (1995) Abb. 10 B.

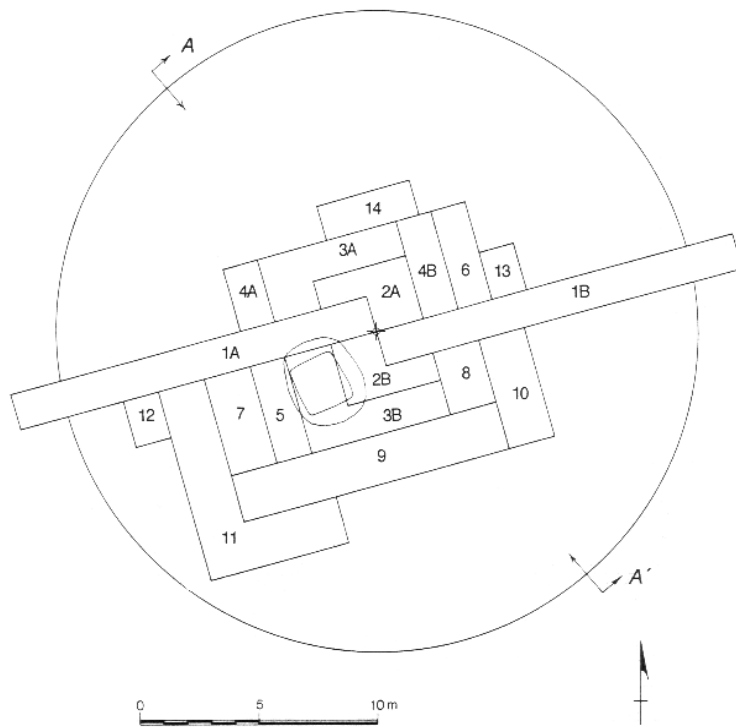

Abb.2 Tumulus C, Schnitt

Quelle: Kohler (1995) Abb. 10 A.

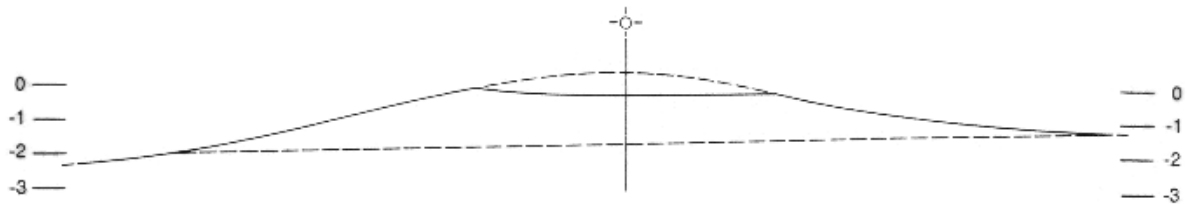

Abb.3 Tumulus C, Kammergrab, W-O Schnitt

Quelle: Kohler (1995) Abb. 11 A.

Taf. 25

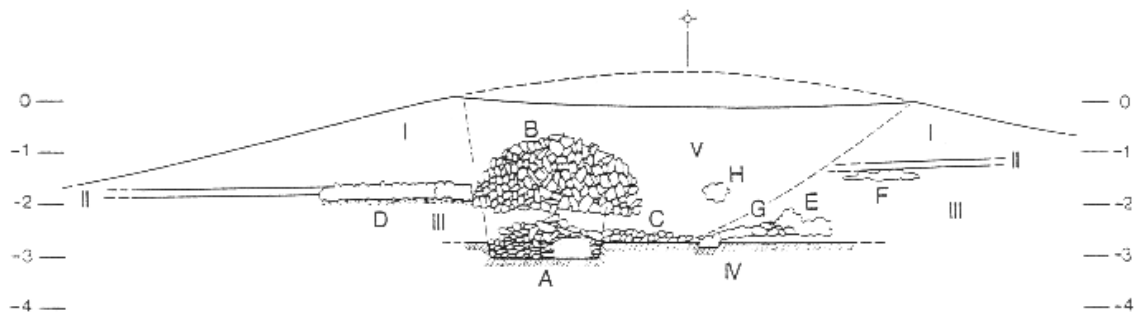

Abb.1 Tumulus I und H, Plan

Quelle: DeVries, FS Young, 1980, 82 Abb. 19.

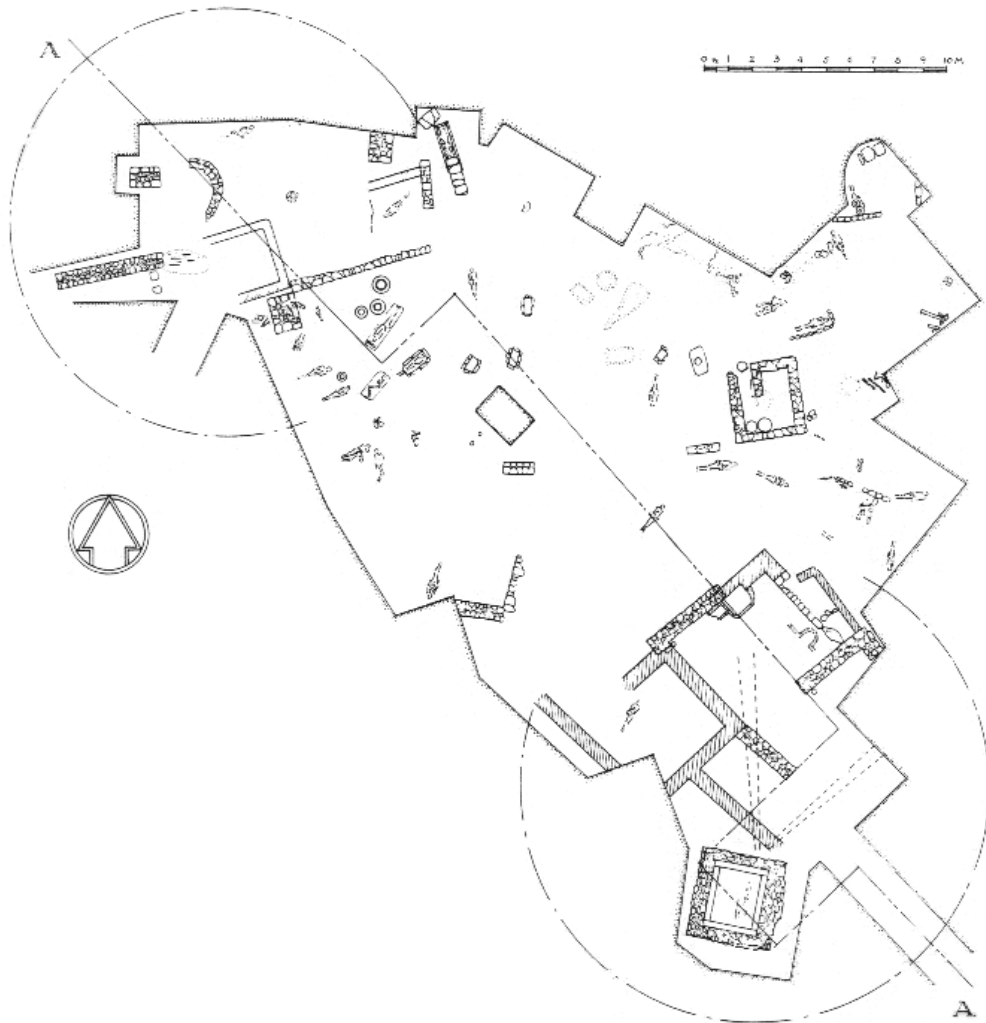

Abb.2 Tumulus A

Quelle: DeVries, FS Young, 1980, 84 Abb. 22.

Taf 26

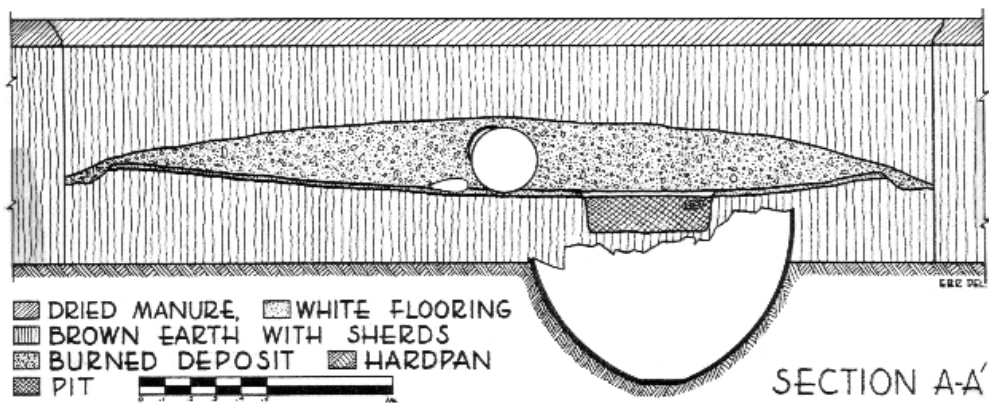

Abb.1 Plan der Nekropole von Ankara

Quelle: Buluc (1979) Taf. 1.

Taf. 27



Abb.1 Plan des Anıttepe

Quelle: Özgüç-Akok, Belleten 11, 1947, 64 r. Taf. 1 Abb. 1.

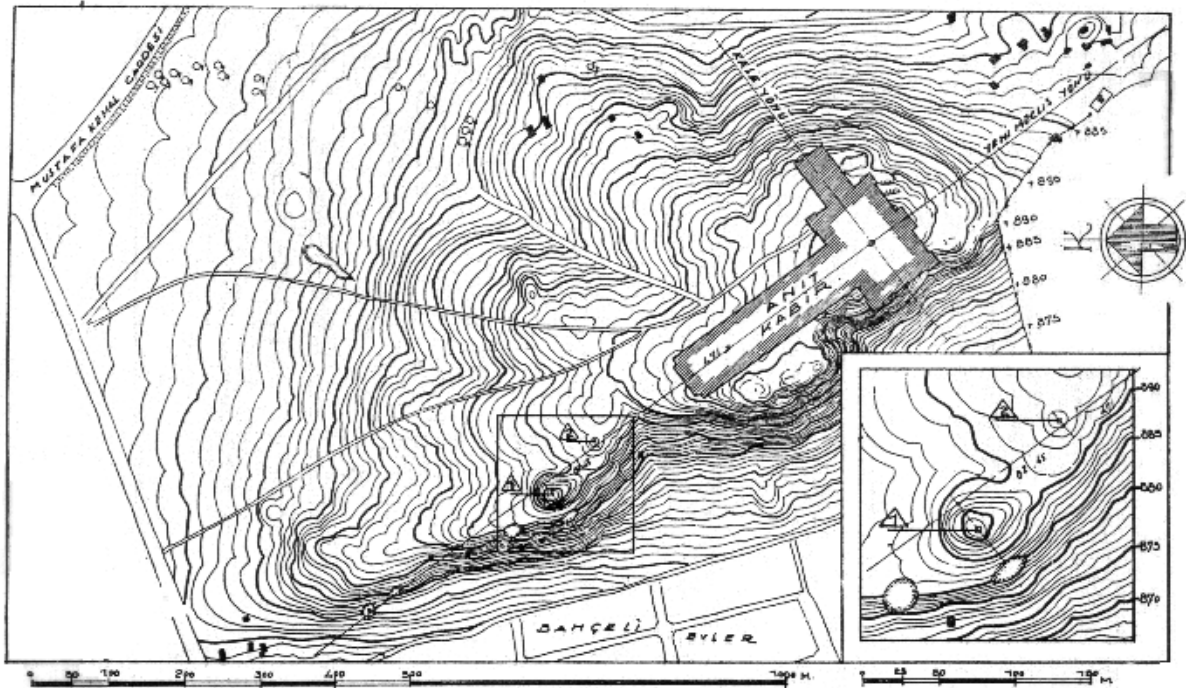

Abb.2 Schnitt und Details des Tumulus Anıttepe I

Quelle: Özgüç-Akok, Belleten 11, 1947, 64 r. Taf. 4 Abb. 5.

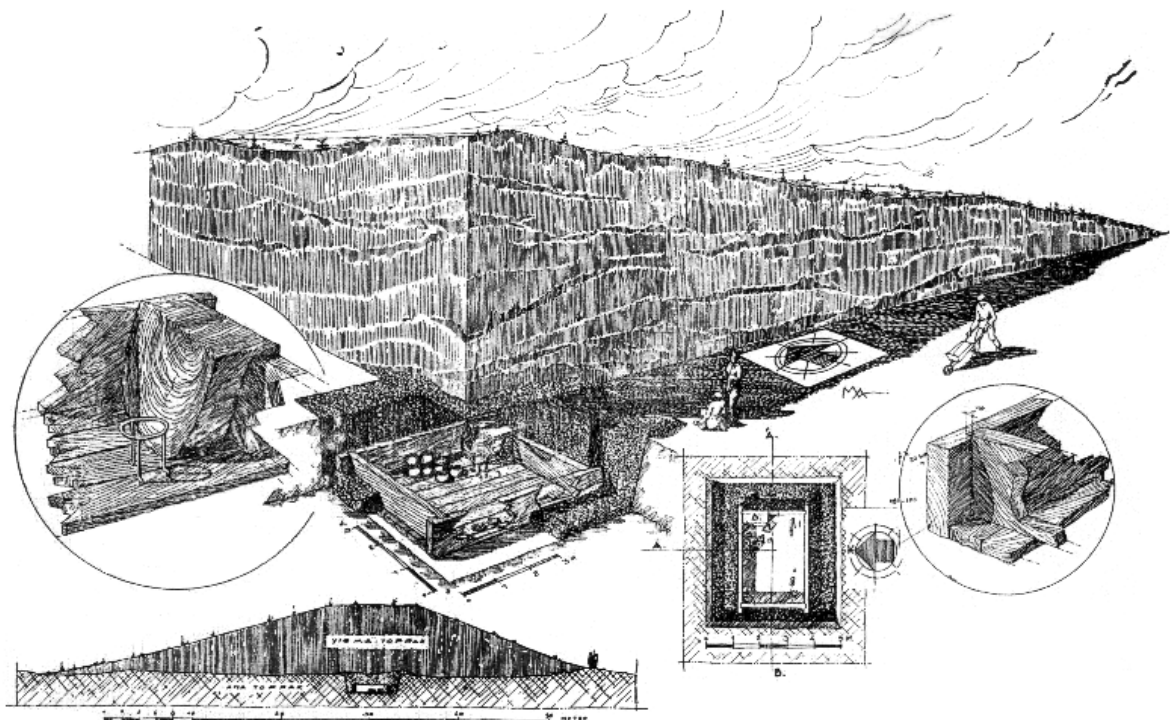

Abb.1 Schnitt und Details des Tumulus Anittepe II

Quelle: Özgüç-Akok, Belleten 11, 1947, 64 r. Taf. 14 Abb. 27.

Taf. 29

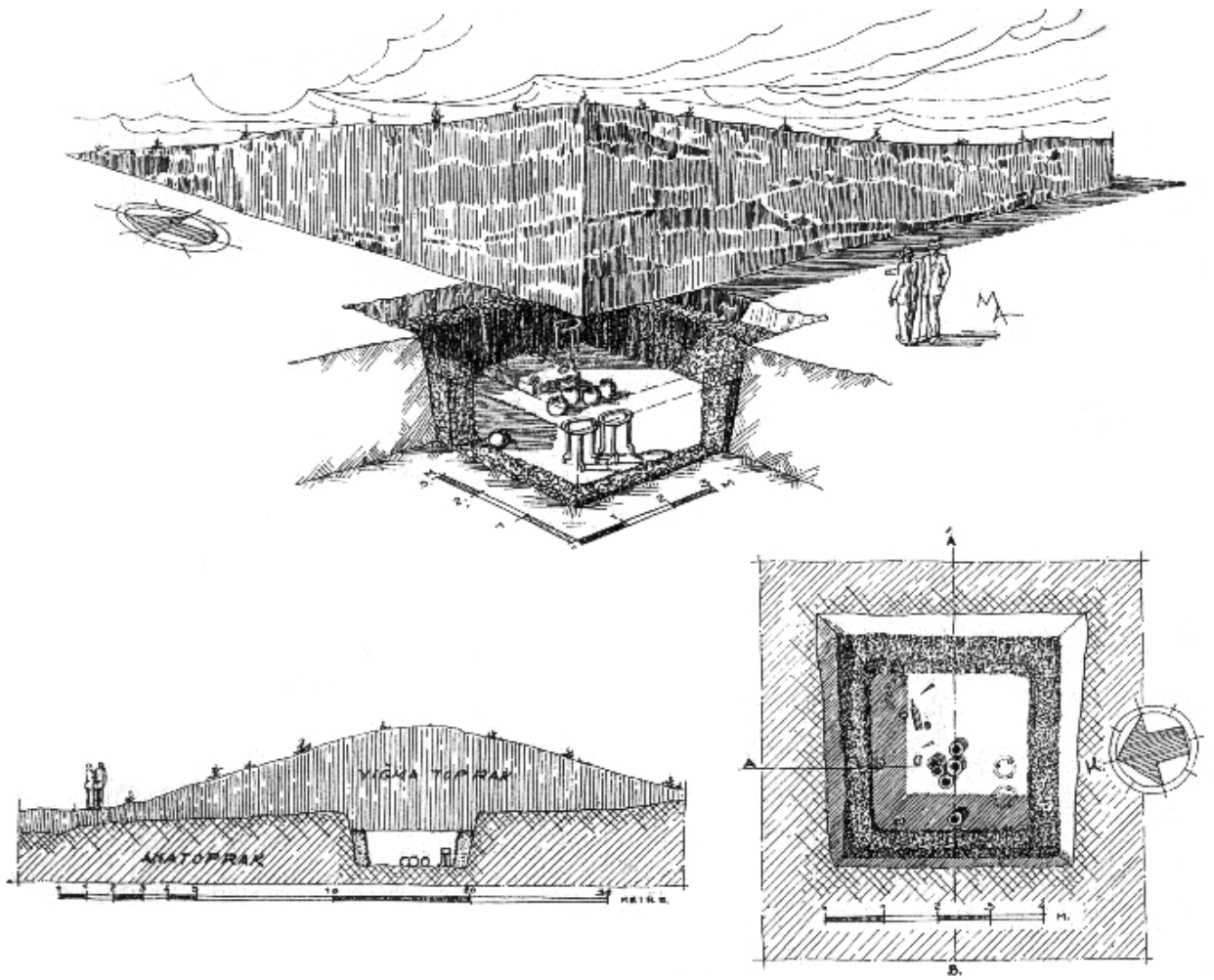

Abb.1 Tumulus B.T.

Quelle: Buluc (1979) Taf.2 Abb. 1.



Abb.2 Tumulus B.T., Schnitt

Quelle: Buluc (1979) Taf.2 Abb. 1.

Taf. 30

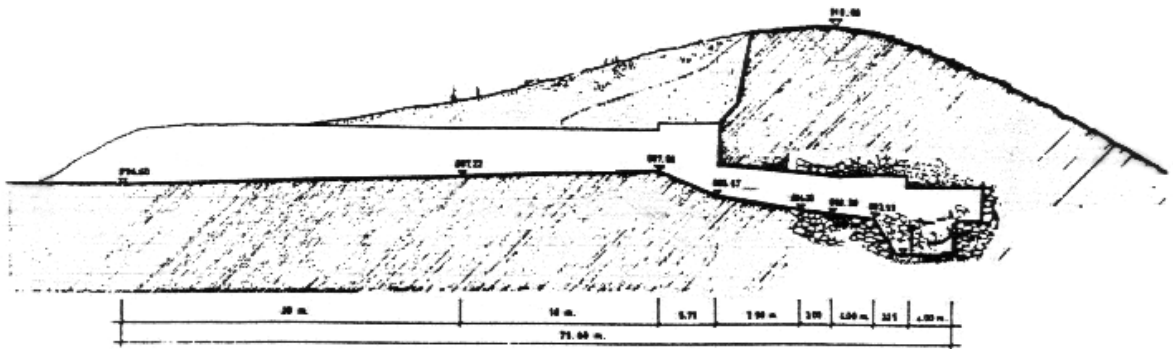

Abb.1 Tumulus B.T., Rekonstruktion der Holzkammer

Quelle: Buluc (1979) Taf.4 Abb. 1.

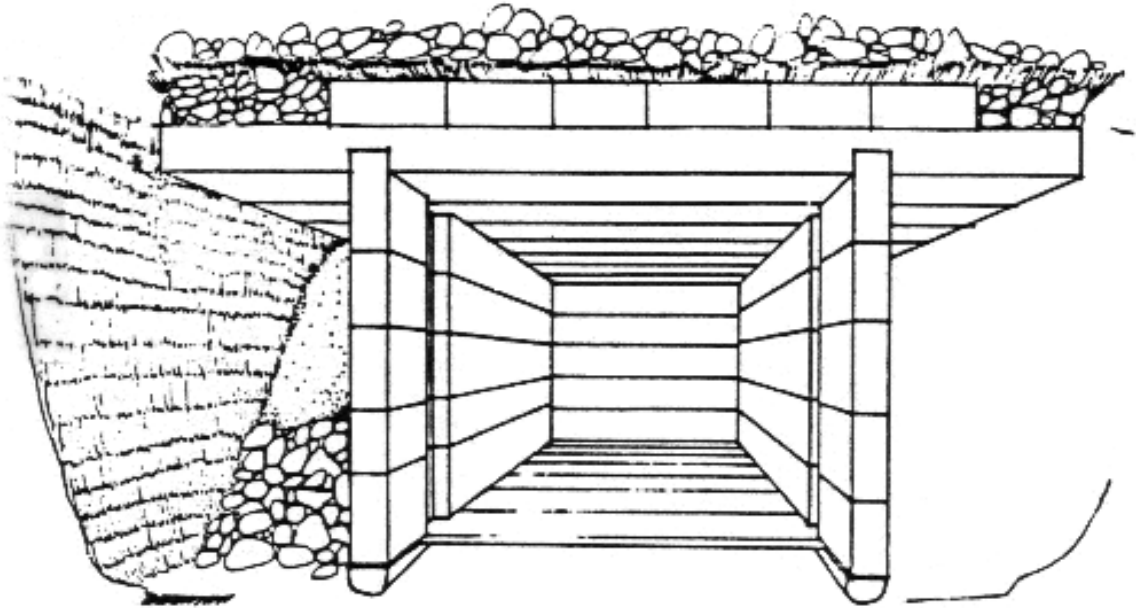

Abb.2 Kizlarkayasi, Schnitte und Detail der Holzkonstruktion in Tumulus A

Quelle: Saatci-Kopar, I. MKKS, 1991, 155.

Taf. 31

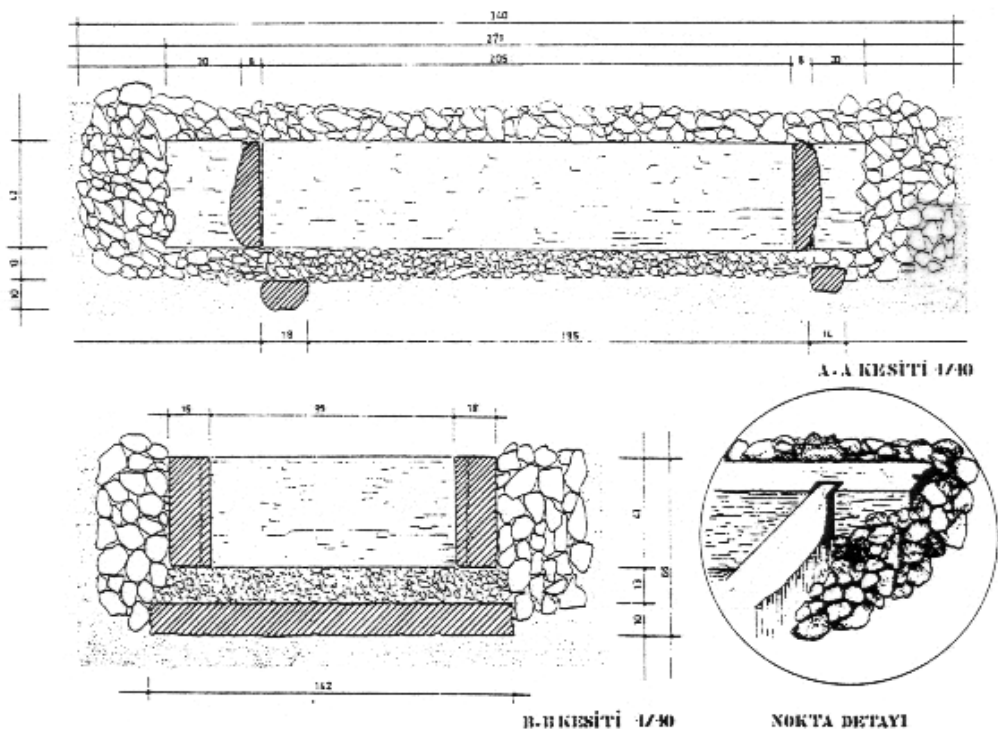

Abb.1 Tatarli, Grundriß der Grabkammer

Quelle: Ucankus, Tatarli, 2002, 190 Abb. 15.

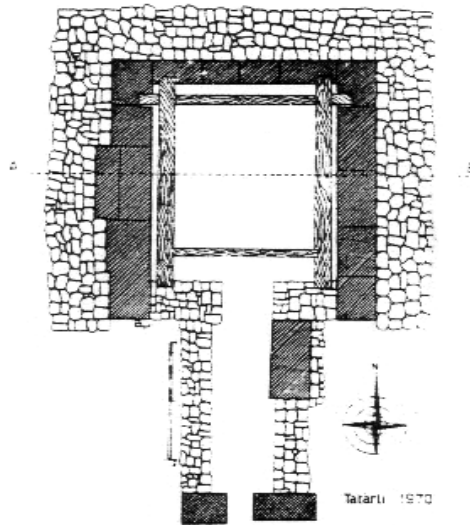

Abb.2 Tatarli, Schnitt durch die Grabkammer

Quelle: Ucankus, Tatarli, 2002, 191 Abb. 17.

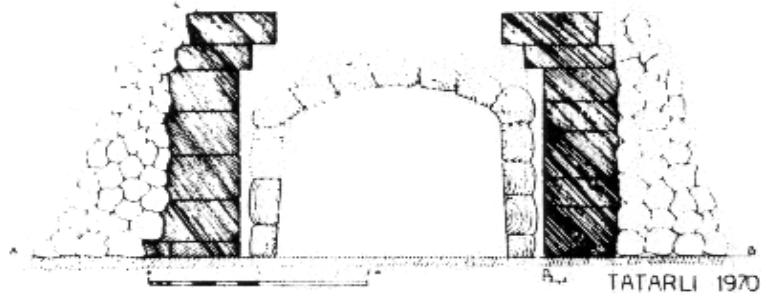

Abb.3 Tatarli, isometrischer Aufriß der Grabkammer

Quelle: Ucankus, Tatarli, 2002, 191 Abb. 16.

Taf. 32

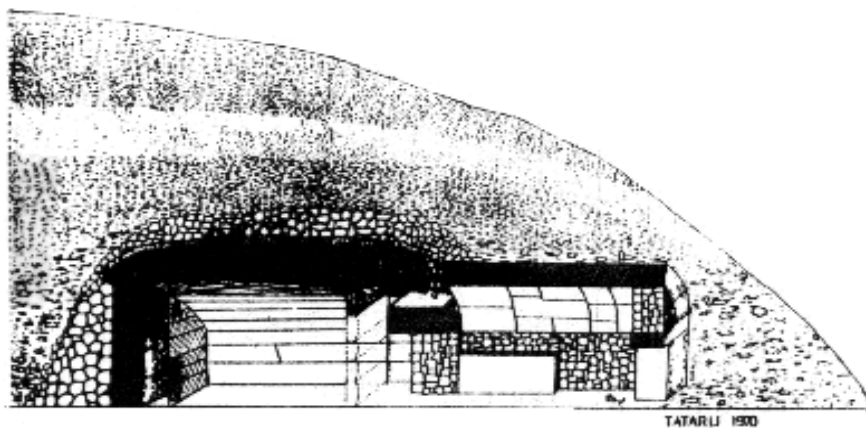

Abb.1 Plan der Nekropole von Sardis

Quelle: Hanfmann, SPRT (1983) Abb. 2.

Taf. 33

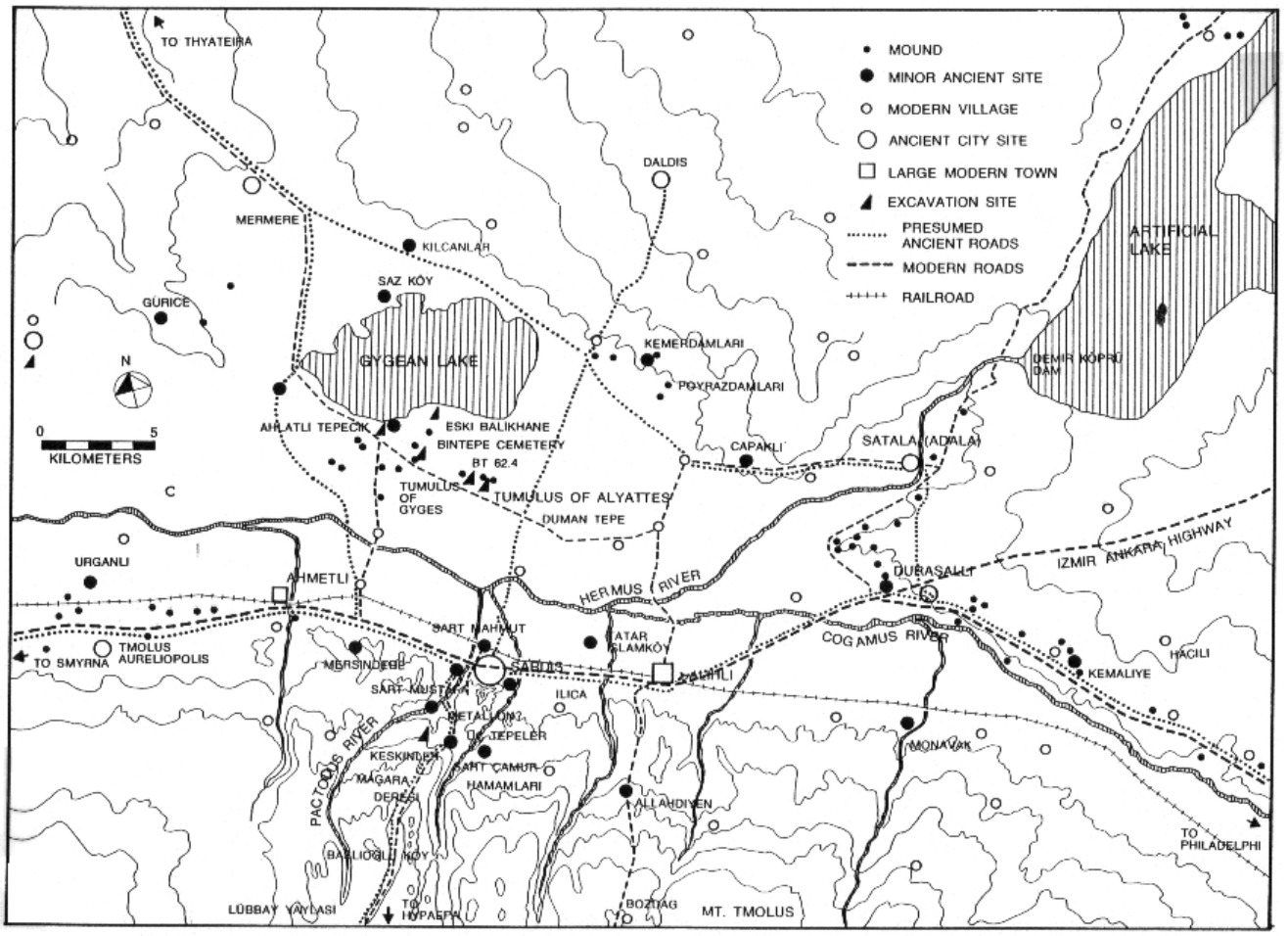

Abb.1 Alyattesgrab, Plan der Suchtunnel

Quelle: Hanfmann, BASOR 170, 1963, 56 Abb. 39.

Taf. 34

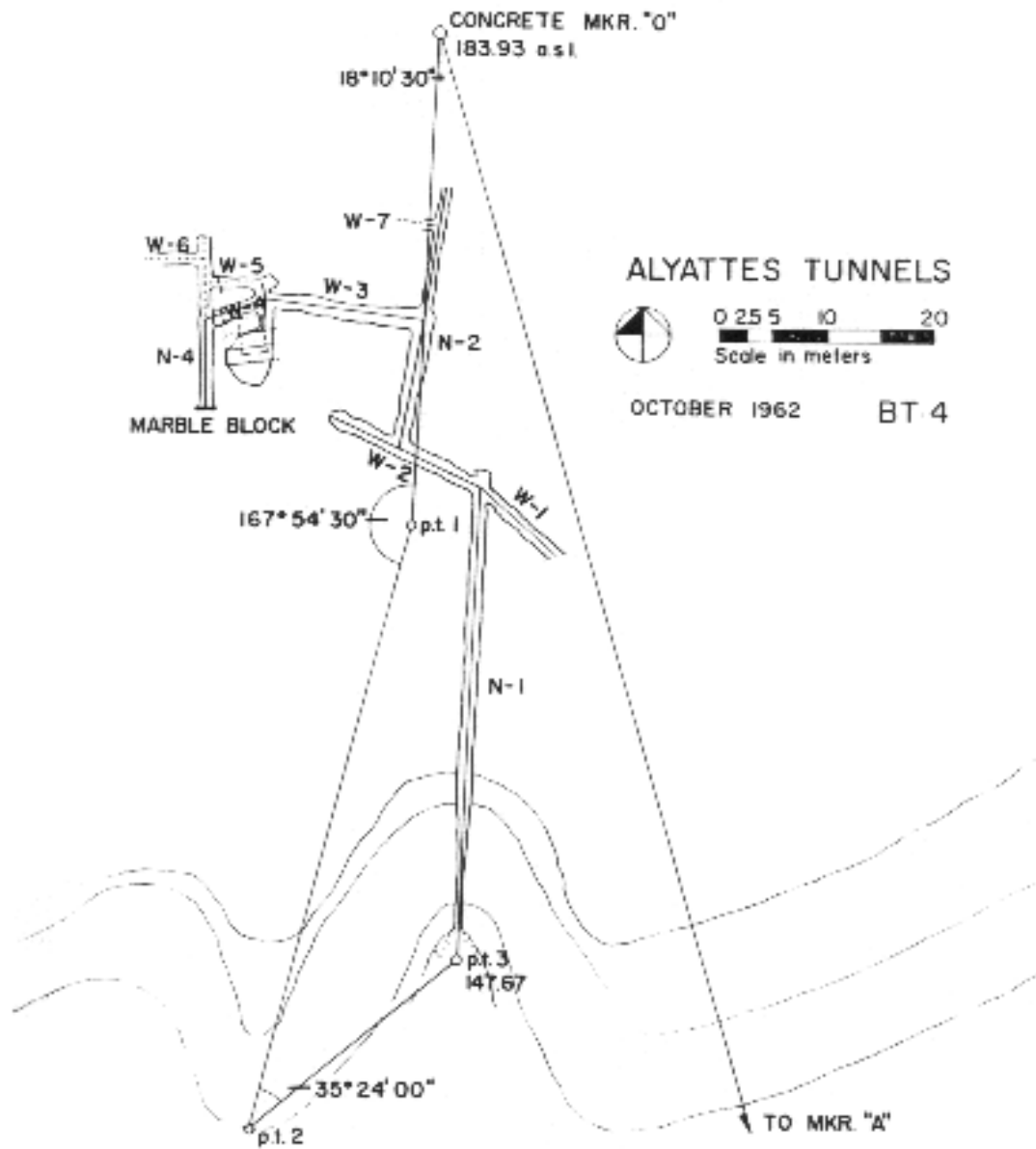

Abb.1 Alyattesgrab, Schnitte und Grundriß der Grabkammer

Quelle: Hanfmann, BASOR 170, 1963, 57 Abb. 40.

Taf. 35

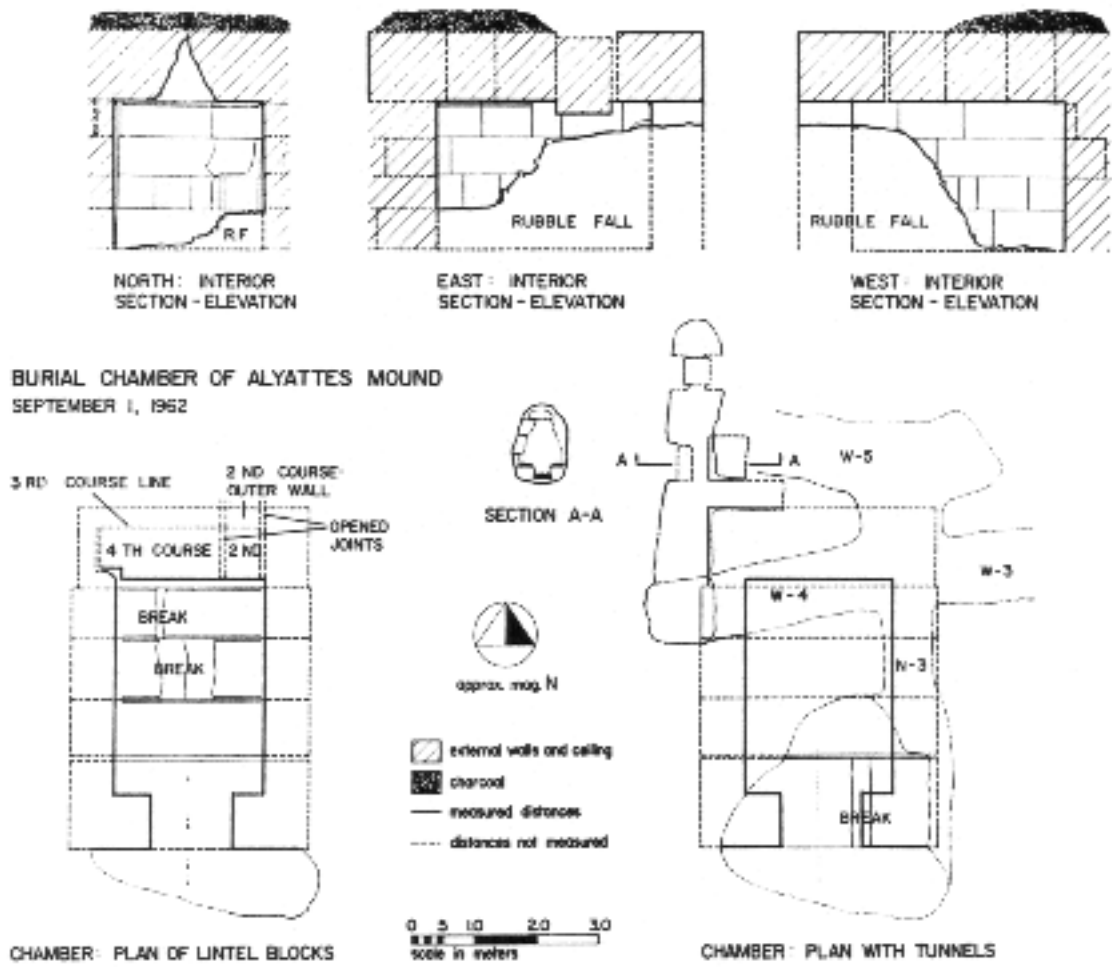

Abb.1 Karniyariktepe, alter und neuer Tumulus

Quelle: Koenigs, Kerameikos (1980) 42 Abb. 20 A.

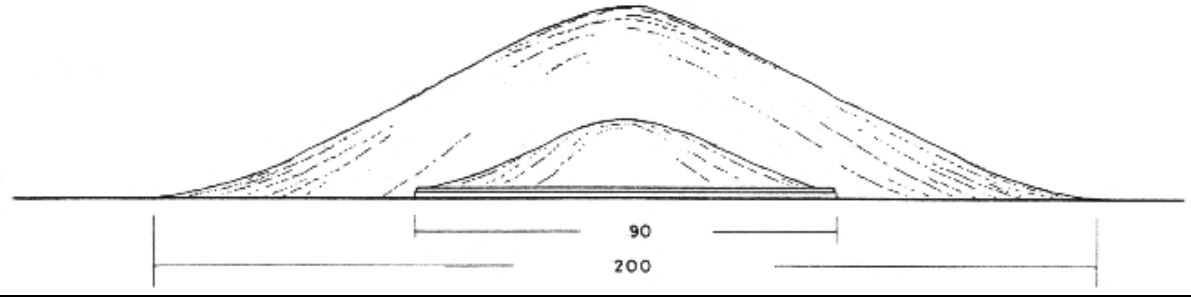

Abb.2 Karniyariktepe, Plan der Suchtunnel und der Krepismauer

Quelle: Hanfmann, SPRT (1983) Abb. 2.

Taf. 36

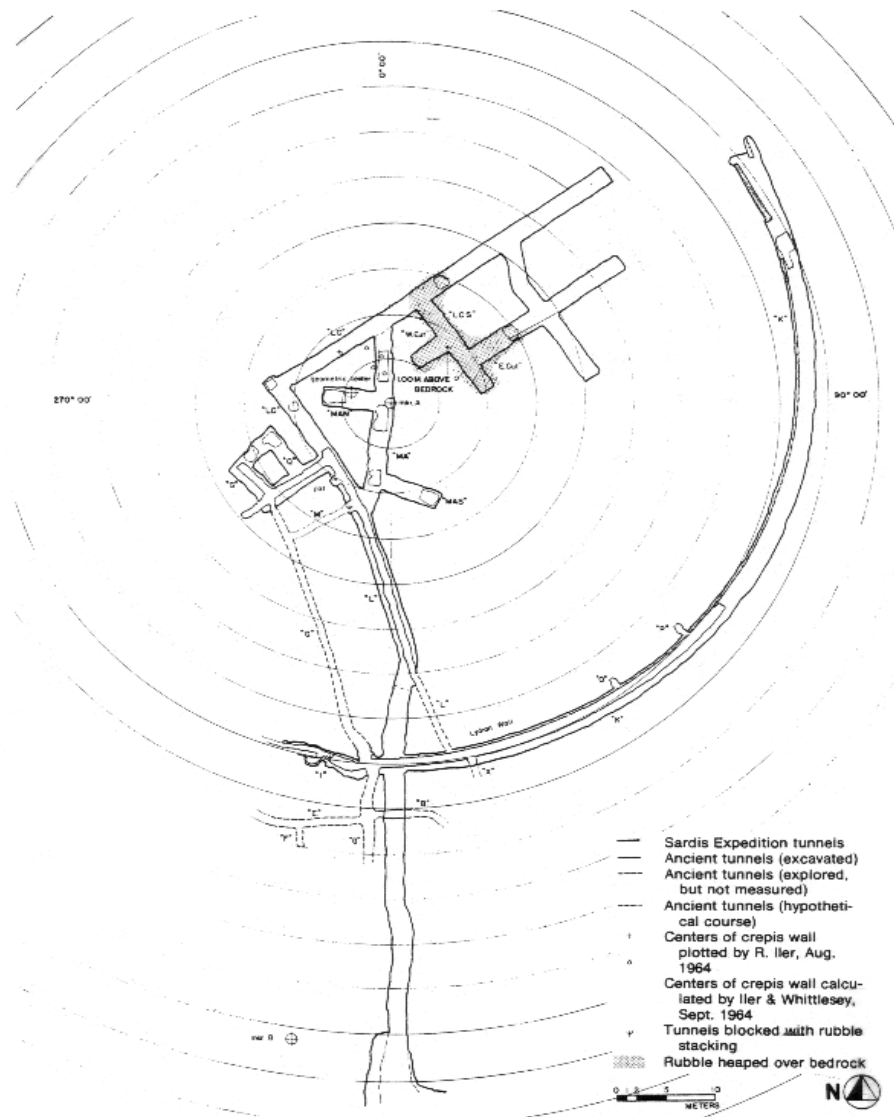

Abb.1 Tumulus BT 62.4, Grundriß und Schnitte

Quelle: Hanfmann, BASOR 170, 1963, 61 Abb. 42.

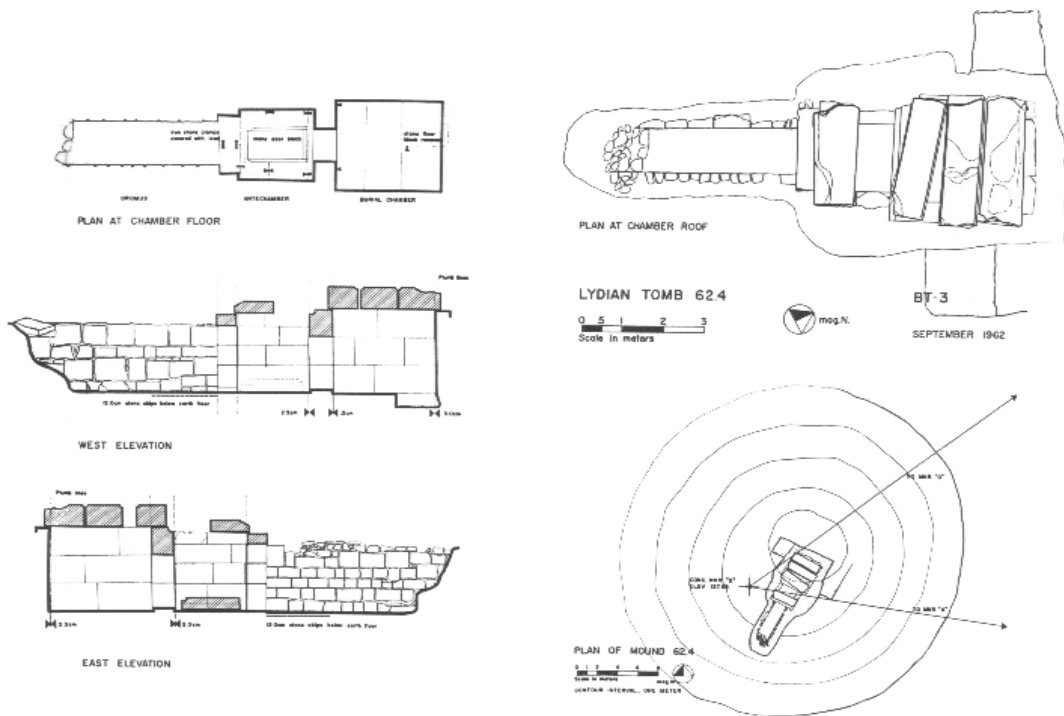

Abb.2 Tumulus BT 62 2, Grundriß und Schnitte

Quelle: Hanfmann, BASOR 174, 1964, 57 Abb. 35.

Taf. 37

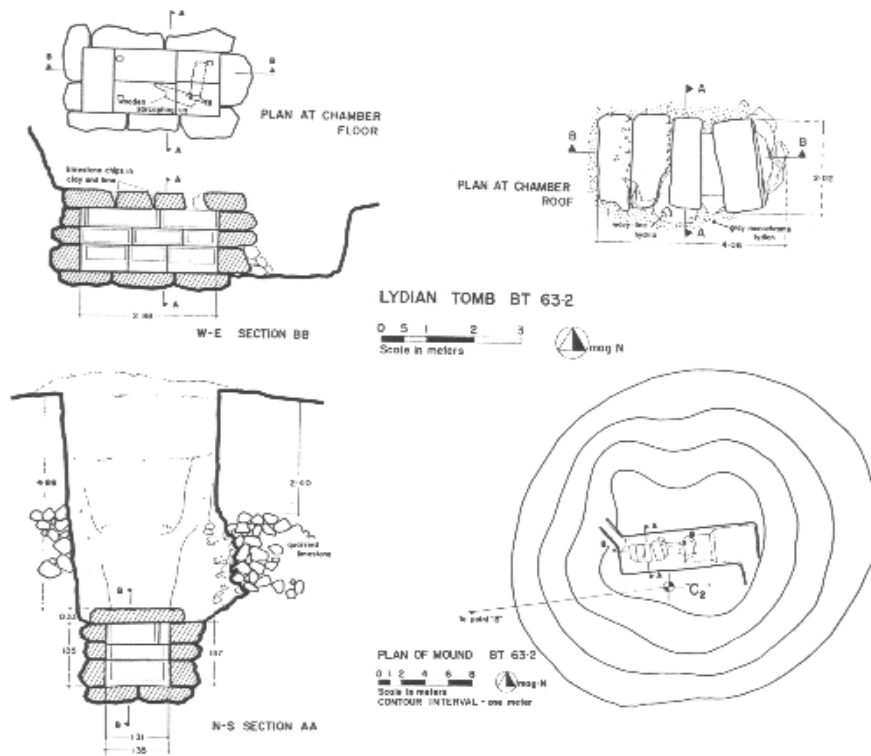

Abb.1 Tumulus BT 66.1, Grundriß und Schnitte der Grabkammer

Quelle: Hanfmann, BASOR 186, 1967, 42 Abb. 28.

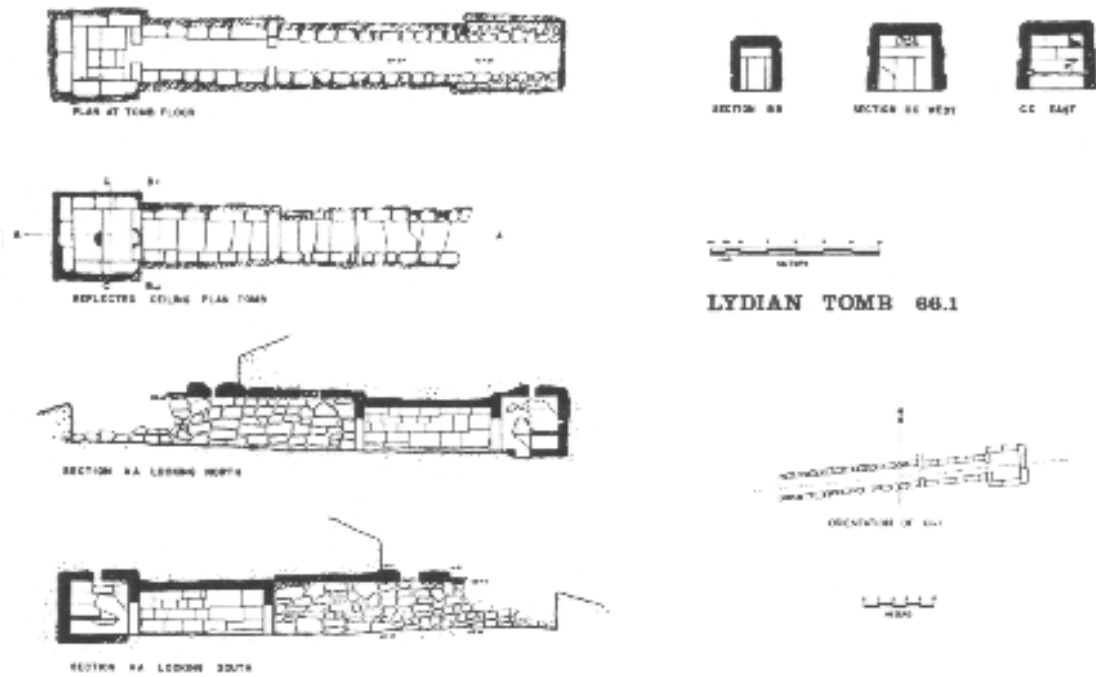

Abb.2 Tumulus BT 89, Schnitt

Quelle: Dedeoglu, Tümüls, 1991, 132 Abb. 1.

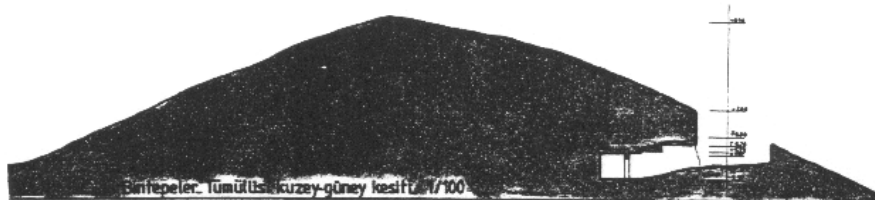

Abb.3 Tumulus BT 89, Grabkammer und Dromos, Plan und Längsschnitt

Quelle: Dedeoglu, Tümüls, 1991, 133 Abb. 2.

Taf. 38

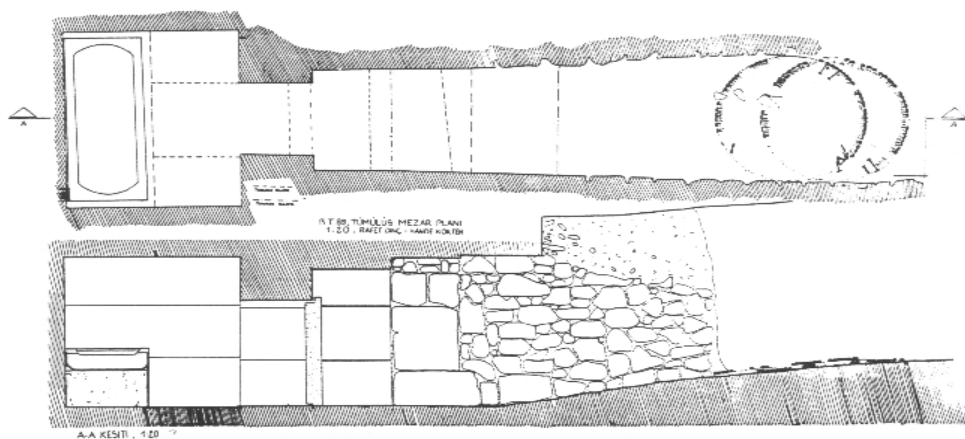

Abb.1 Tumulus BK 71, 1 Grabkammer, Plan und Schnitte

Quelle: Ramage, BASOR 206, 1972, 12 Abb. 1.

Taf. 39

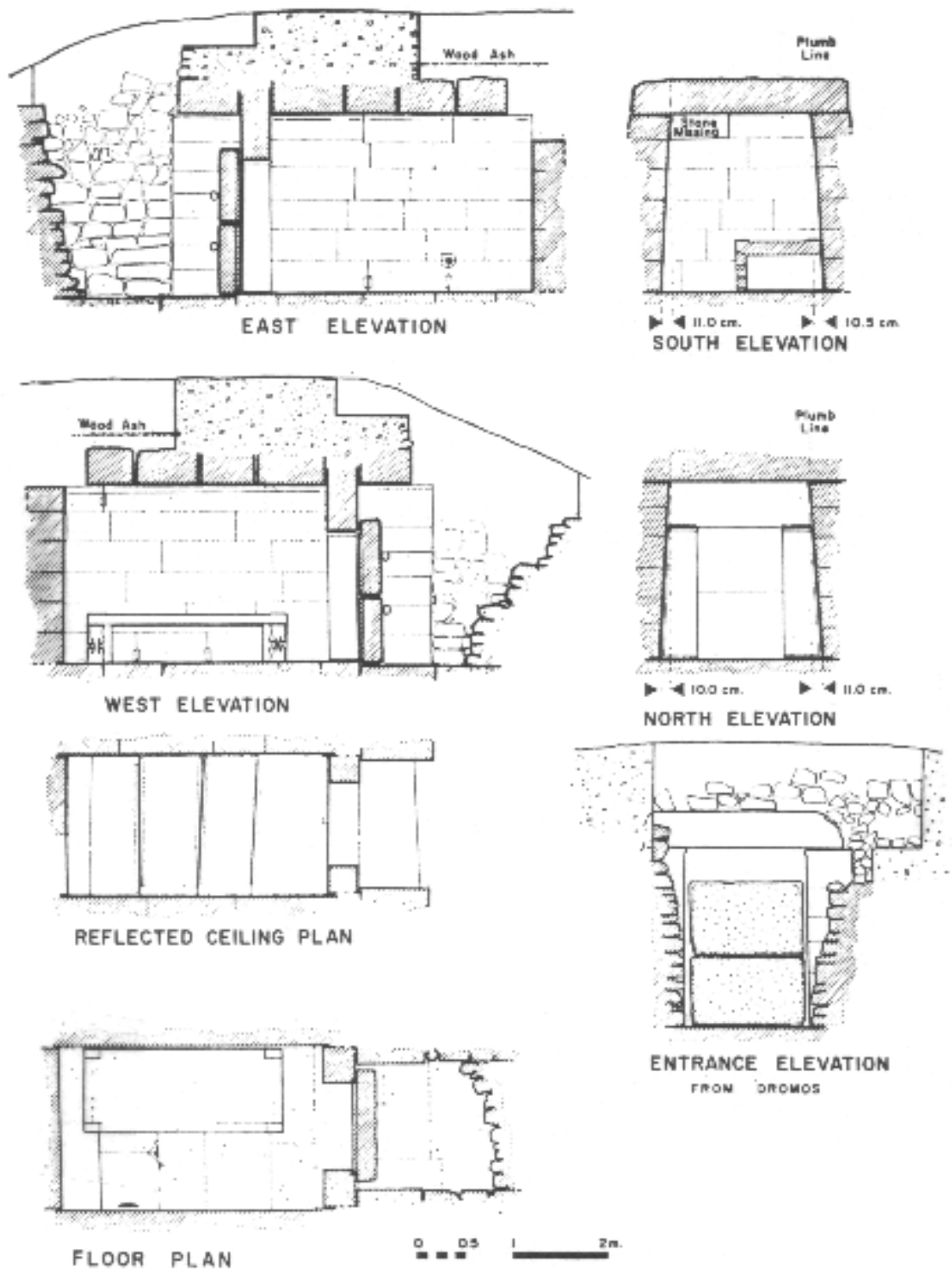

Abb.1 Tumulus T 1 Alahidir, Grabkammer, Längsschnitt und Aufsicht

Quelle: Nayir, Alahidir, 1979, Taf. 4 Abb. 9.

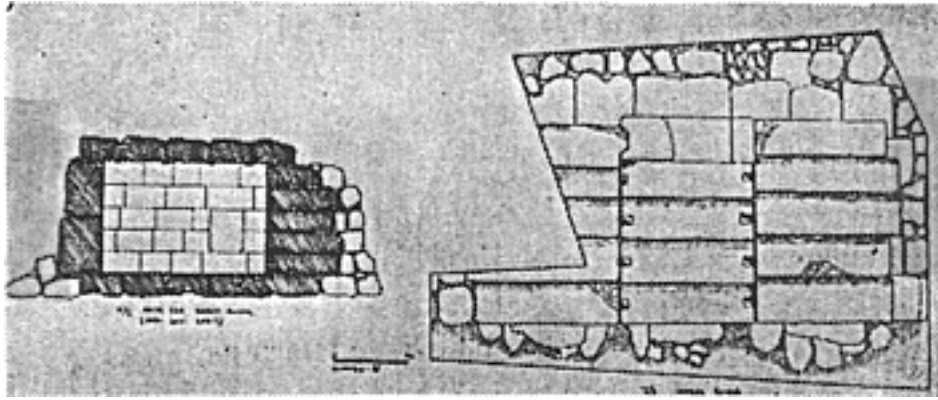

Abb.2 Tumulus T 1 Alahidir, Grabkammer, Schnitt und Konstruktionsdetails

Quelle: Nayir, Alahidir, 1979, Taf. 5 Abb. 11.

Taf. 40

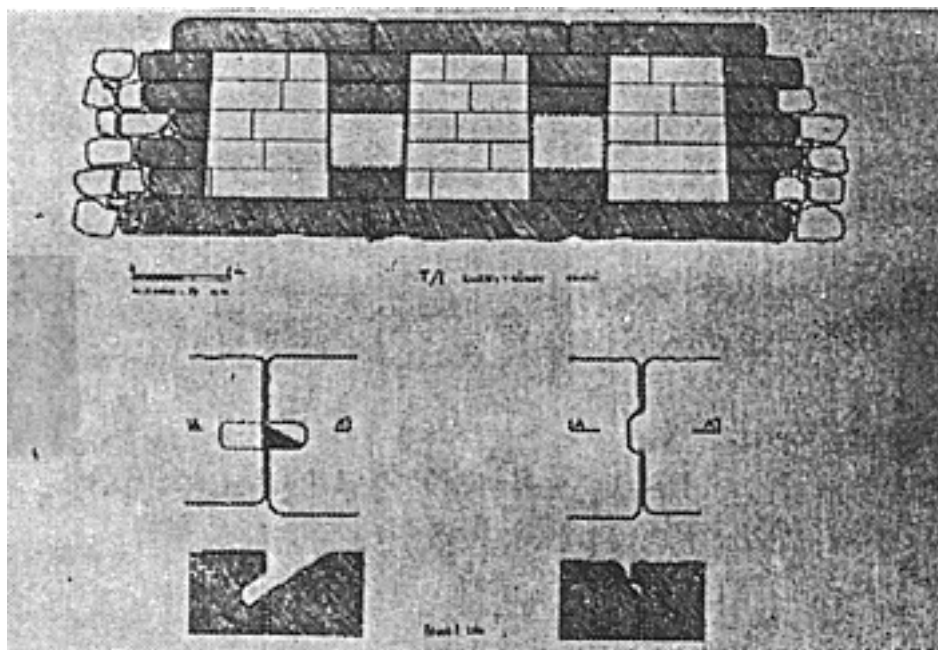

Abb.1 Tumulus Basmacitepe, Plan

Quelle: Akbiyikoglu, 1991, 9 Plan 1.

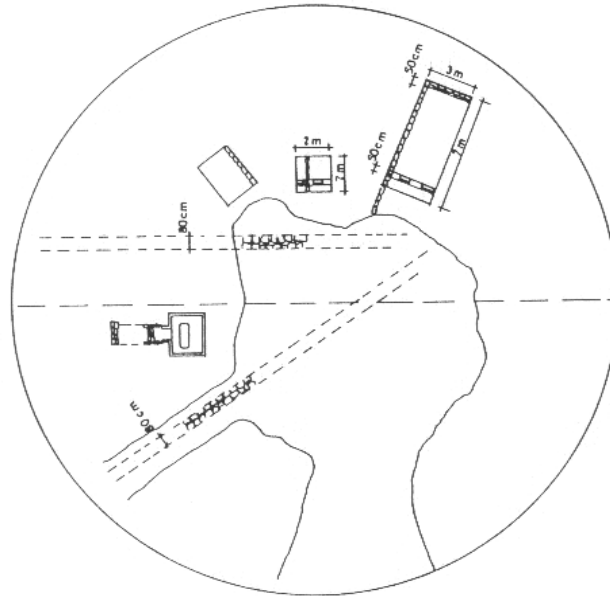

Abb.2 Basmacitepe, Plan der Grabanlage

Quelle: Akbiyikoglu, 1991, 10 Plan 2.

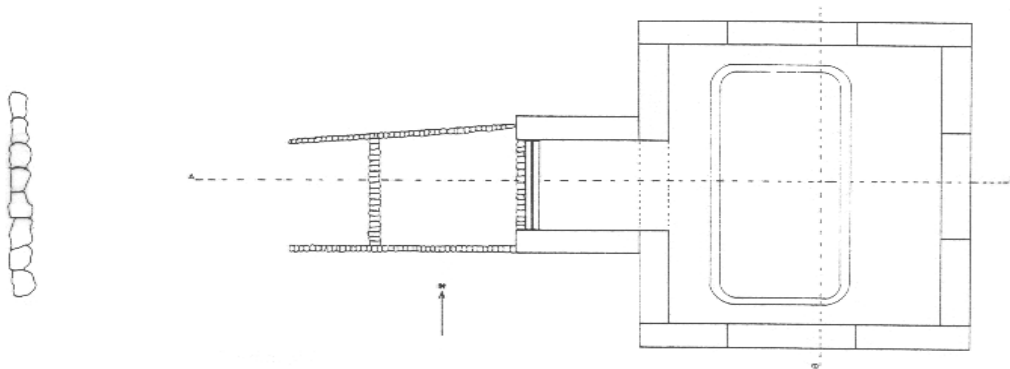

Abb.3 Basmacitepe, Schnitt der Grabanlage

Quelle: Akbiyikoglu, 1991, 11 Plan 3.

Taf. 41

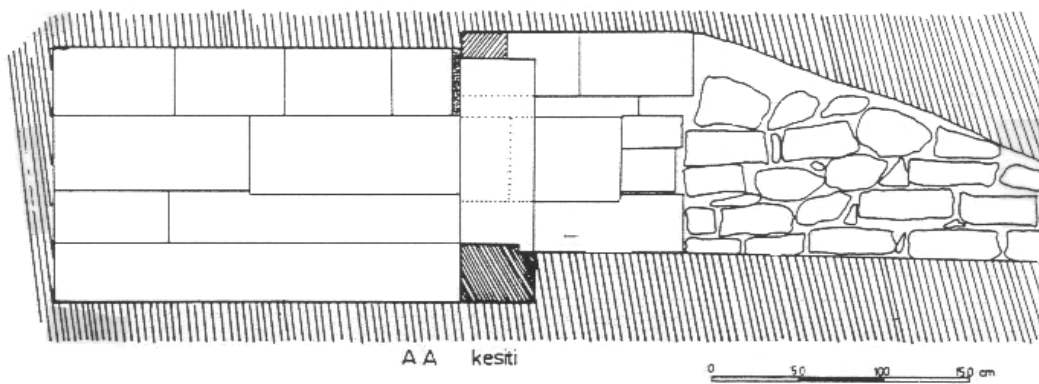
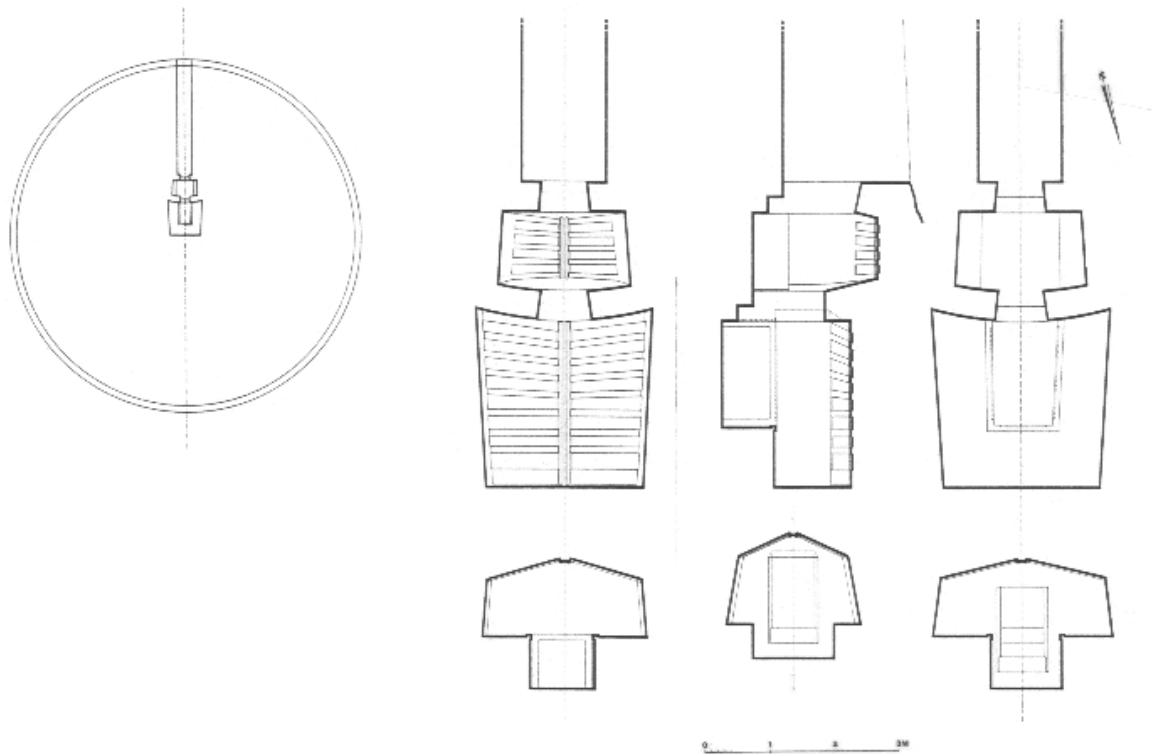

Abb.1 Tumulus A1, Grundriß und Details der Grabanlage

Quelle: Kasper, Soma, 1970, Abb. 5 A, D-I.