



Baden-Württemberg

LANDESAMT FÜR DENKMALPFLEGE
IM REGIERUNGSPRÄSIDIUM STUTTGART

Uwe Gross

**Merowingerzeitliche Siedlungskeramik
(2. Hälfte 5. – 1. Hälfte 8. Jh.)
in Südwestdeutschland**



Abb. 14. Formen der rauhwandigen Drehscheibenkeramik (Kaschau Gruppen 1-4) vom Runden Berg (nach RB IX Taf. 10; 30; 36; 42; 45; 49; 51). – M. 1:4.

(nach Quast 2008, mit Ergänzungen)



Abb. 13. Formen der rauhwandigen Drehscheibenkeramik (Kaschau Gruppen 5, 8, 9) vom Runden Berg (nach Spors-Gröger [wie Anm. 45] 389; 399; 404; 407; 421; 426; 437).

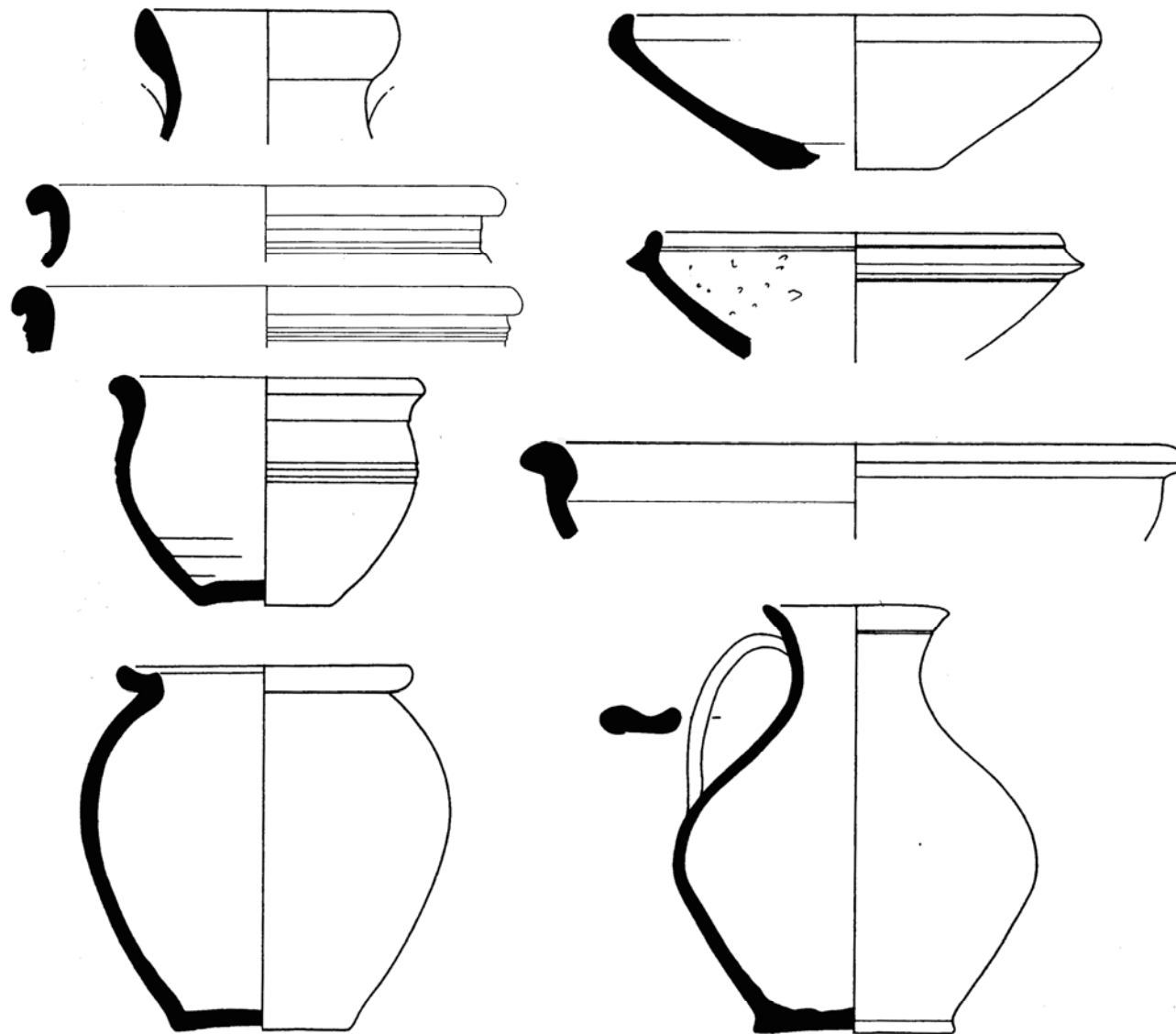

Archäologische Untersuchungen zu Sülchen

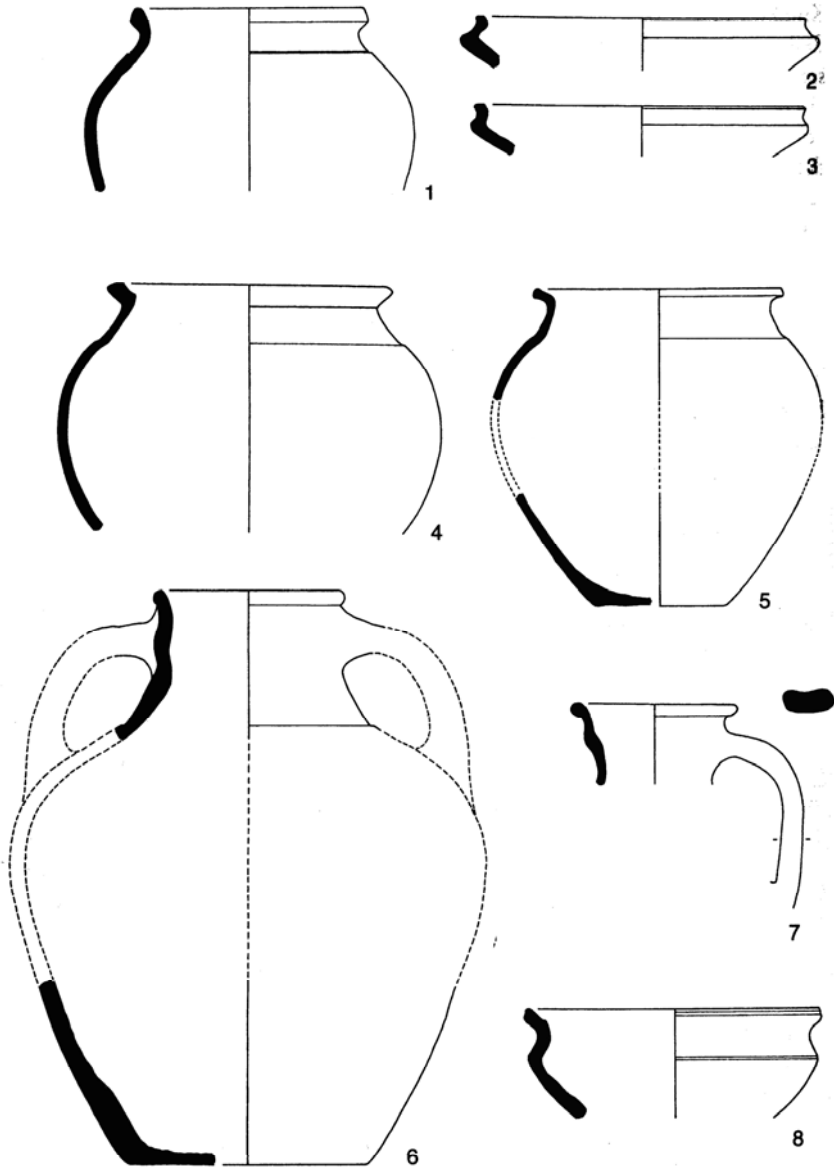

Abb. 5. Wüstung Sülchen: rauhwandige Ware

(nach Gross/Schmidt 2003/04)

Abb. 6. Wüstung Sülchen: rauhwandige Ware

Rauwandige Drehscheibenware Donzdorfer Art

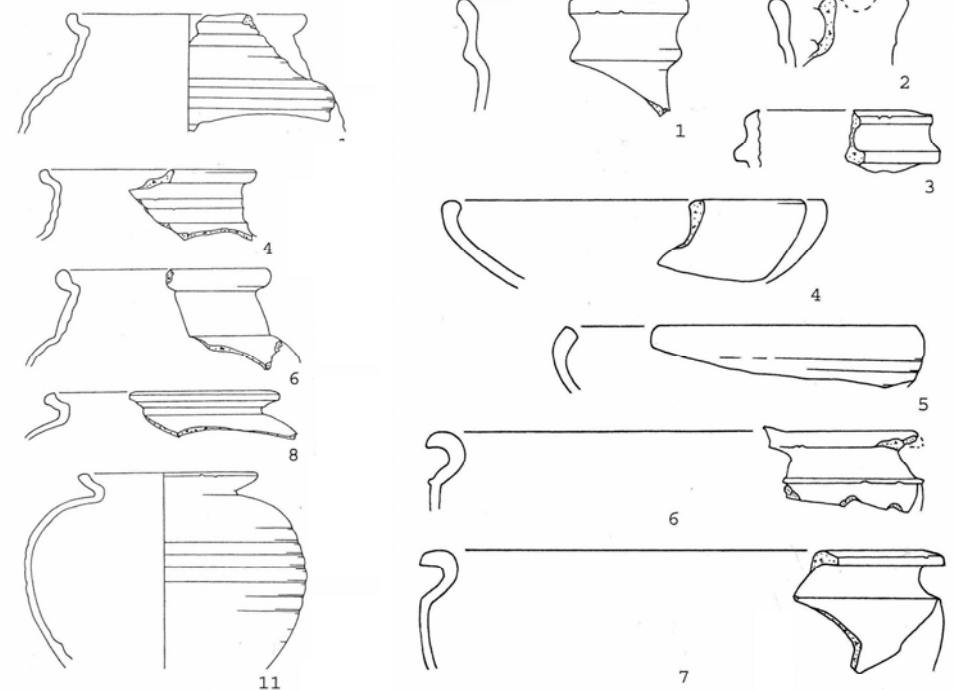
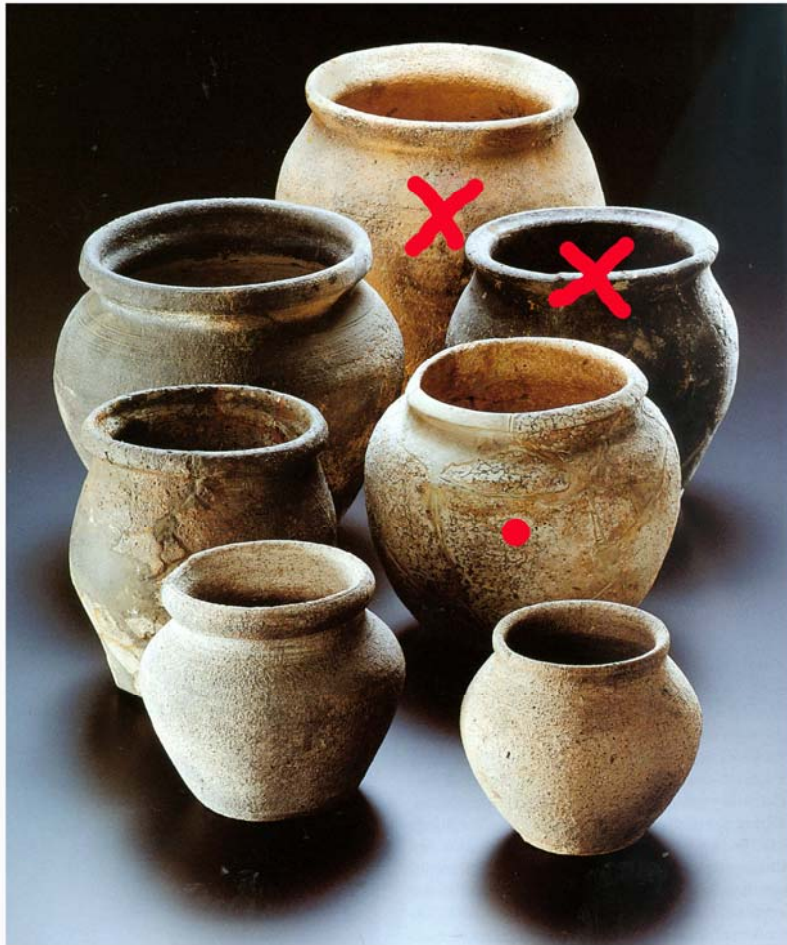

- Gefäß aus Donzdorfer Töpferofen
 - ✗ keine Rauwandige Drehscheibenware Donzdorfer Art
- (aus: Die Alamannen (1997))

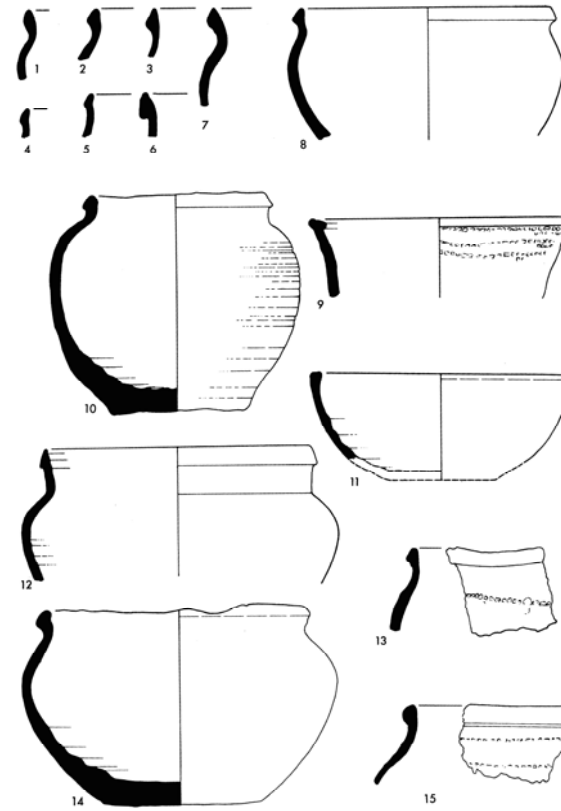

Donzdorf. Funde aus dem Töpferofen
(nach Hübener/Lobbedey 1964)

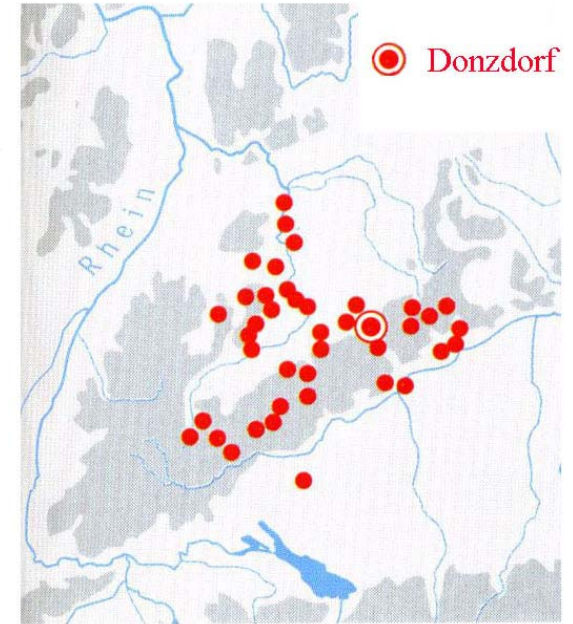

Verbreitung von Rauwandiger Drehscheibenware Donzdorfer Art (aus: Die Alamannen (1997))

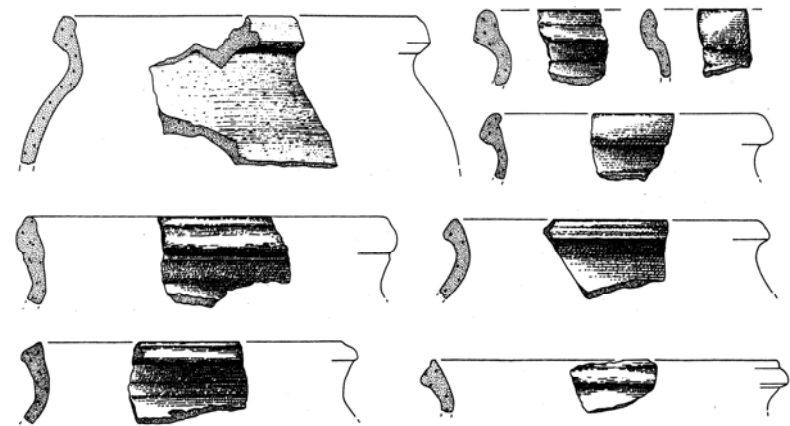

Ursprung. Rauwandige Drehscheibenware Donzdorfer Art (nach Maier 1994)



Abb. 1 Neuhausen a. d. F., Kr. Esslingen. Rauwandige Drehscheibenware. 1-6 Reduzierend gebrannt. 7-14 Oxidierend gebrannt. M. 1:2. (aus: Gross 2008)



Abb. 2 Neuhausen a. d. F., Kr. Esslingen. Rauwandige Drehscheibenware. 1-6 Reduzierend gebrannt. 7-13 Oxidierend gebrannt. M. 1:2.

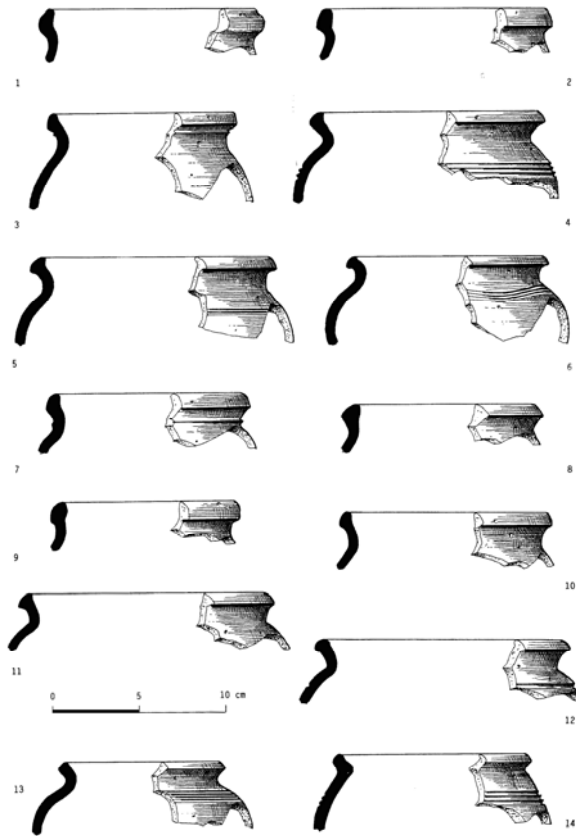

Verbreitung von Keramik Neuhausener Art (nach Gross 2004)

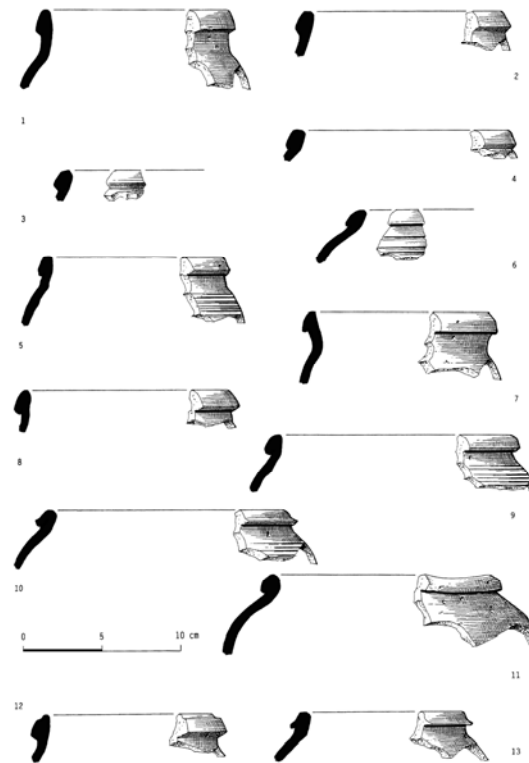
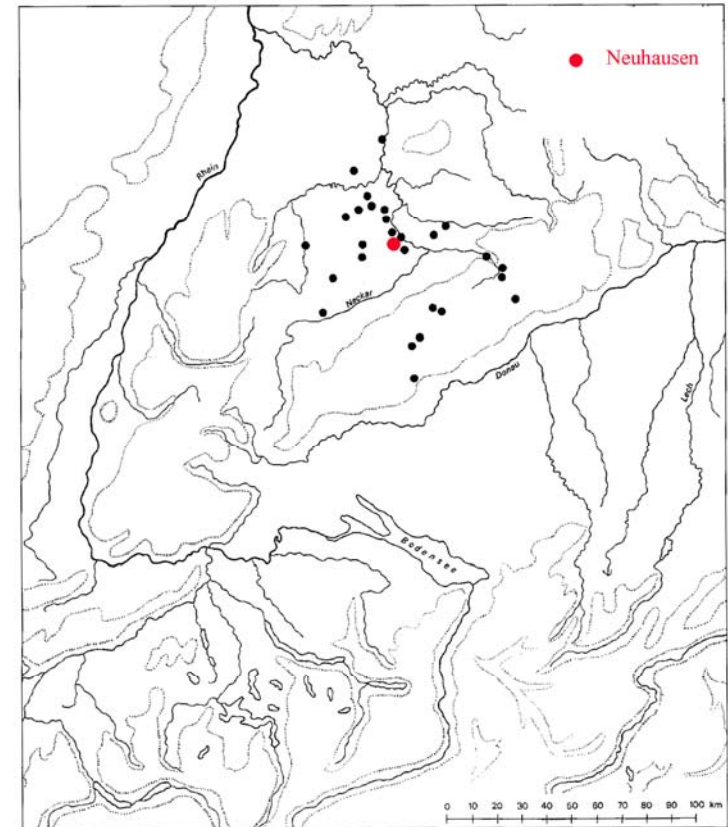

Abb. 145 Neuhausen. Prefibelfibel der späten Merowingerzeit. M 1:2



Neuhausen a.d.F. (nach Gross 1993)

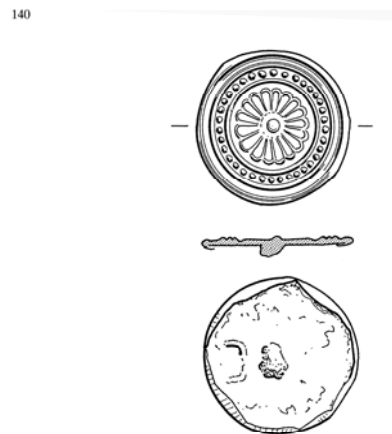
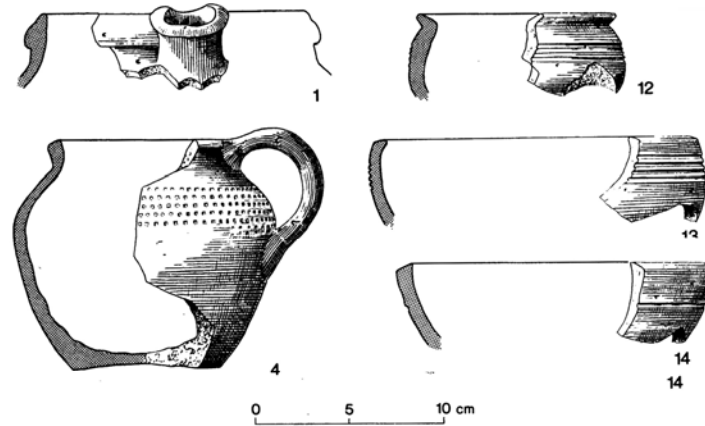

Fehlbrände

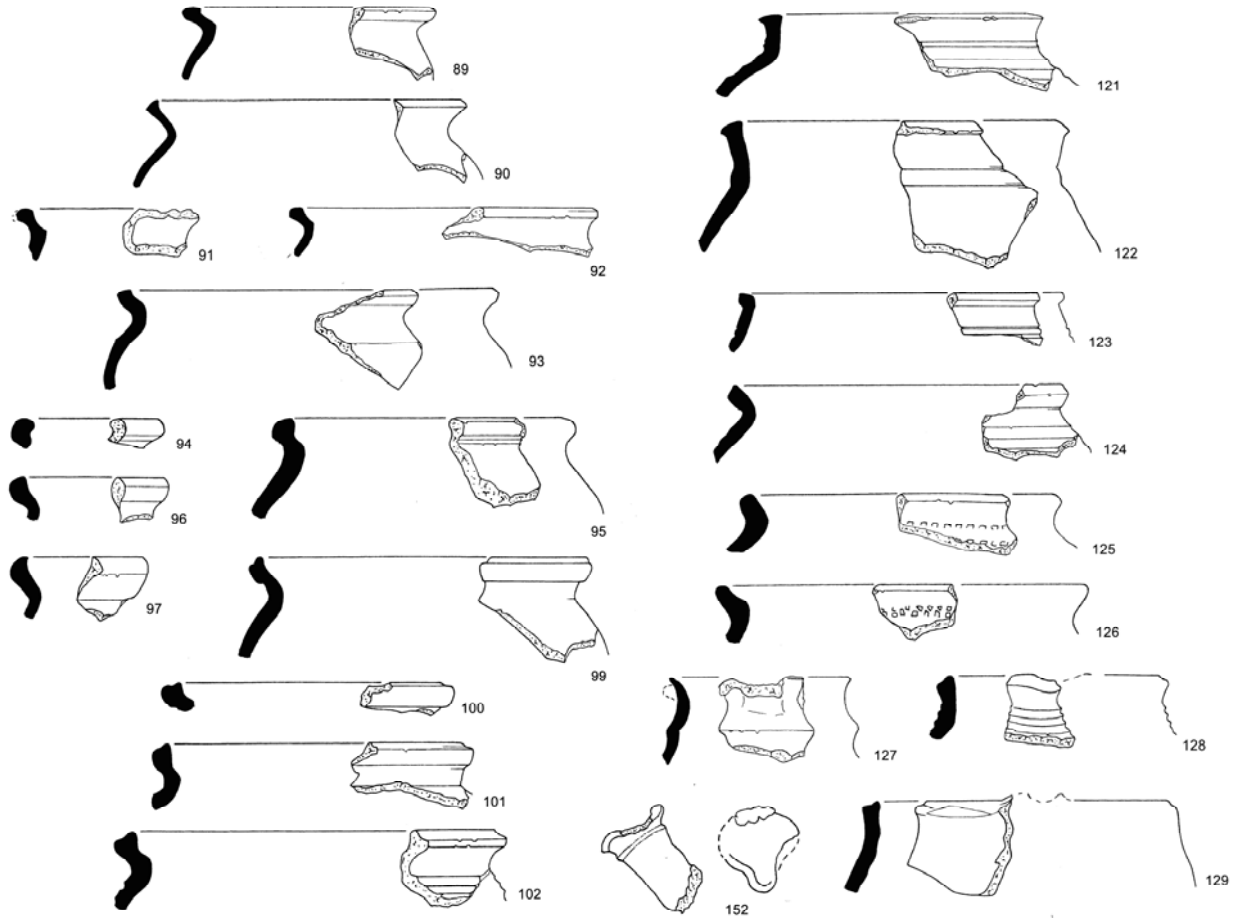
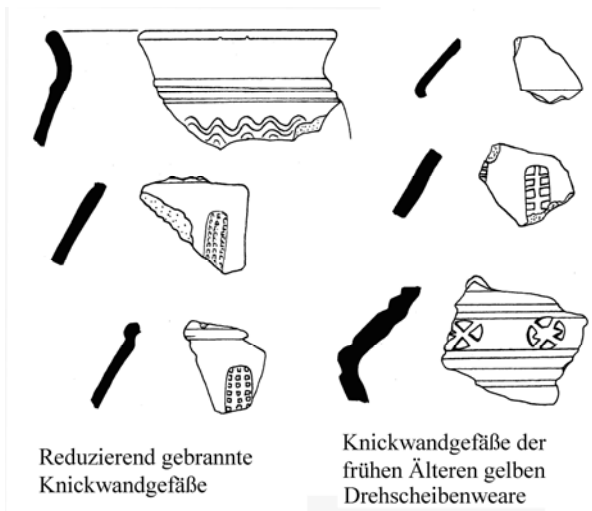

„Muffenheim“. Siedlungsfunde der frühesten Älteren gelben Drehscheibenware (nach Gross 2007)



Abb. 12. Formen der einglättverzierten Keramik (Kaschau Gruppe 6) vom Runden Berg
(nach RB II Taf. 13 und 14). – M. 1:4.



Abb. 7. Wüstung Sülchen; feintonige Ware
(nach Gross/Schmidt 2003/04)

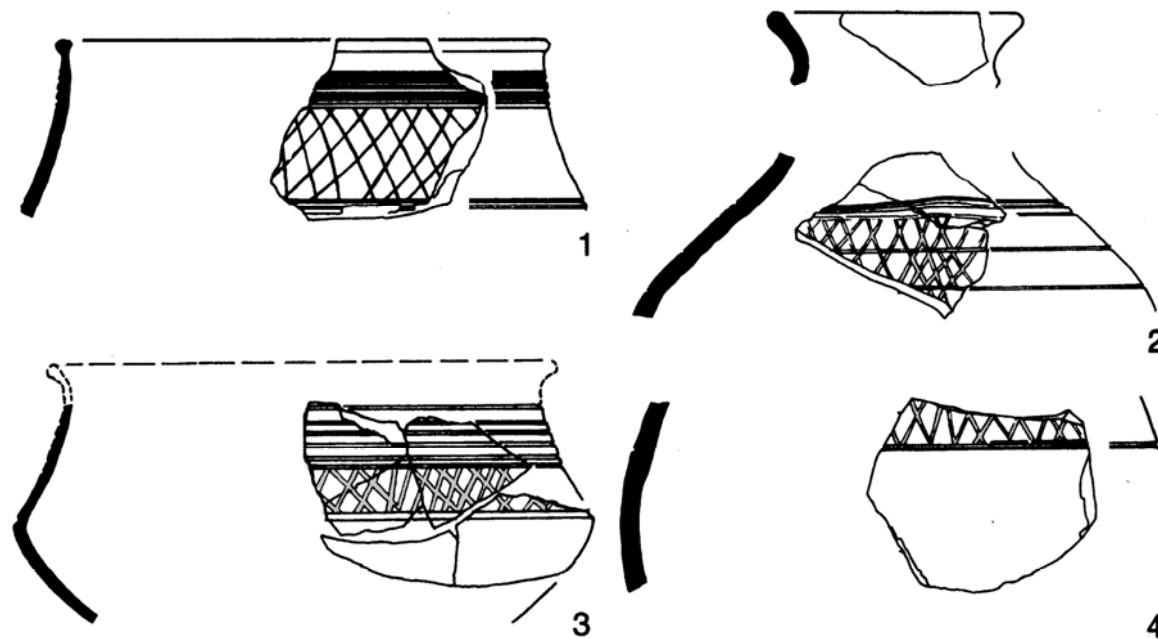

T285
Sülchen
Feintonige, geglättete
Becher

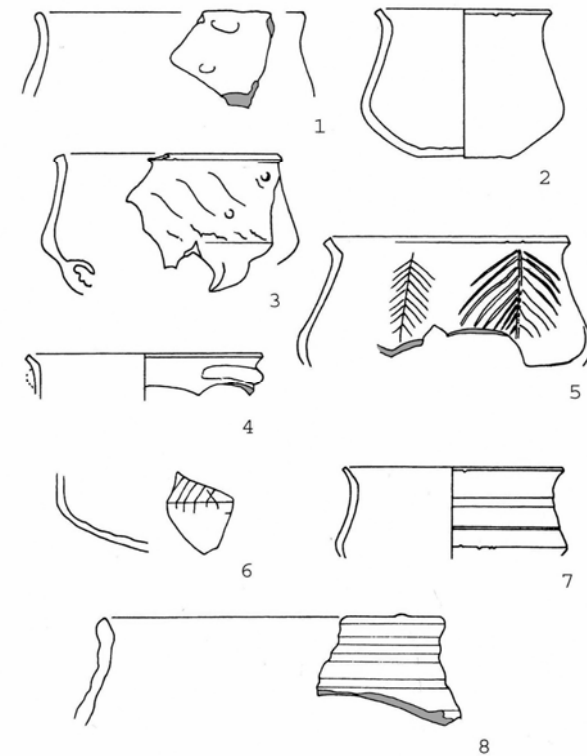
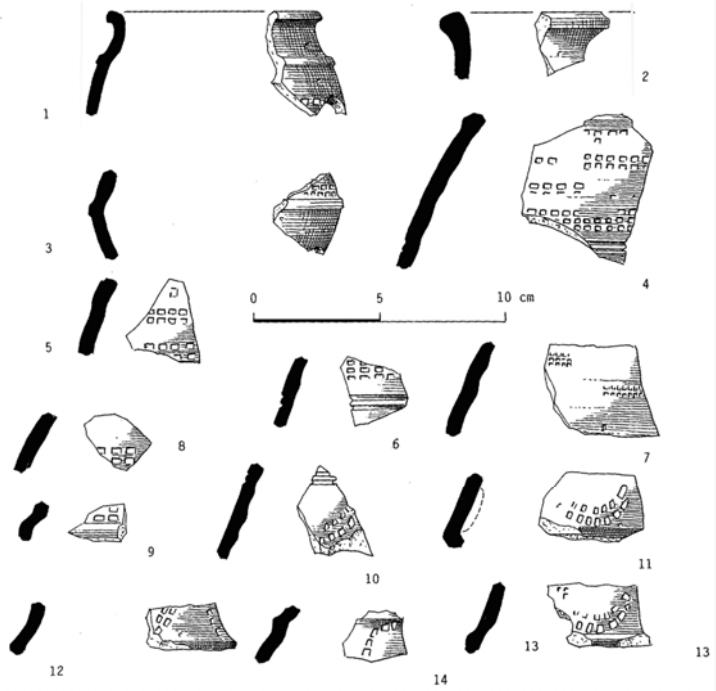

Grhs.

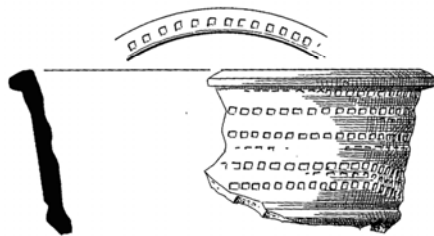

Mannheim-Vogelstang
(nach Damminger/Gross (2009))

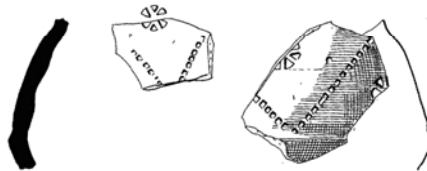

Grhs.

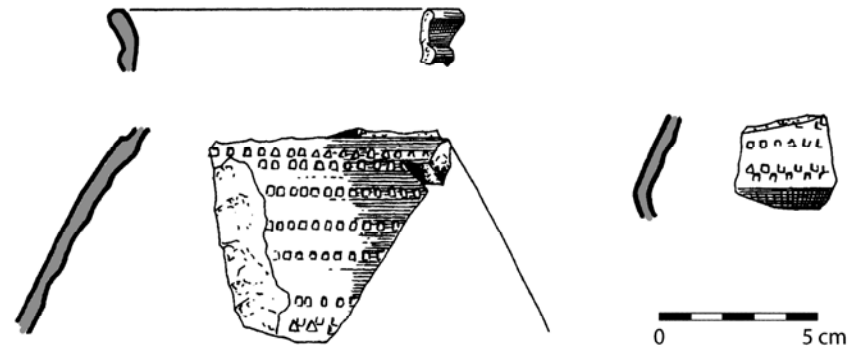

Ulm-Weinhof
(nach Kottmann/Gross 2009)

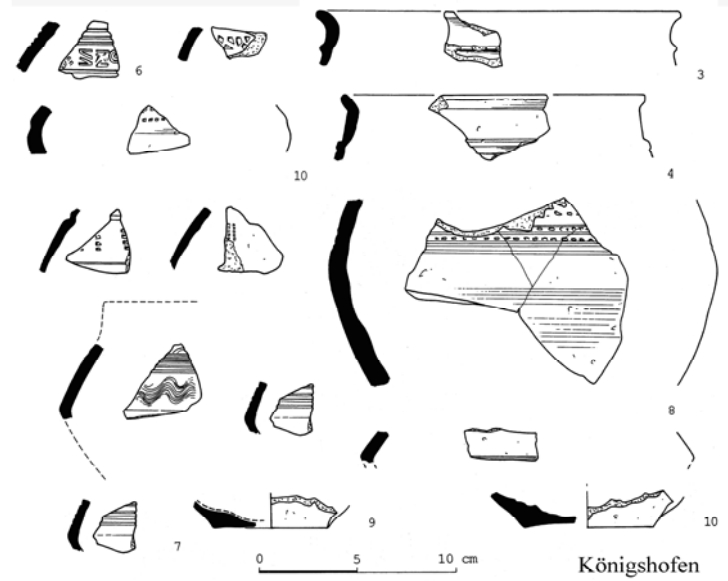

Königshofen

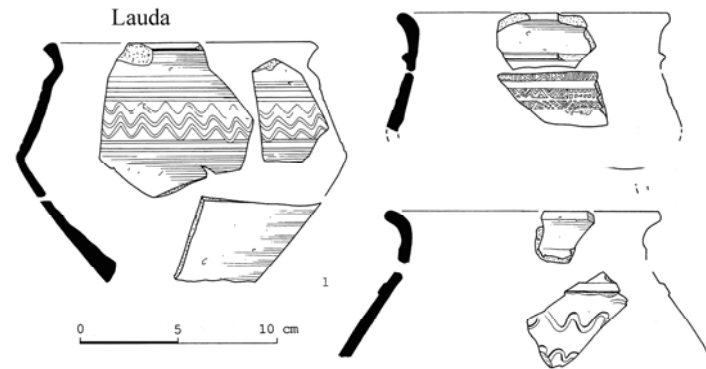

Lauda

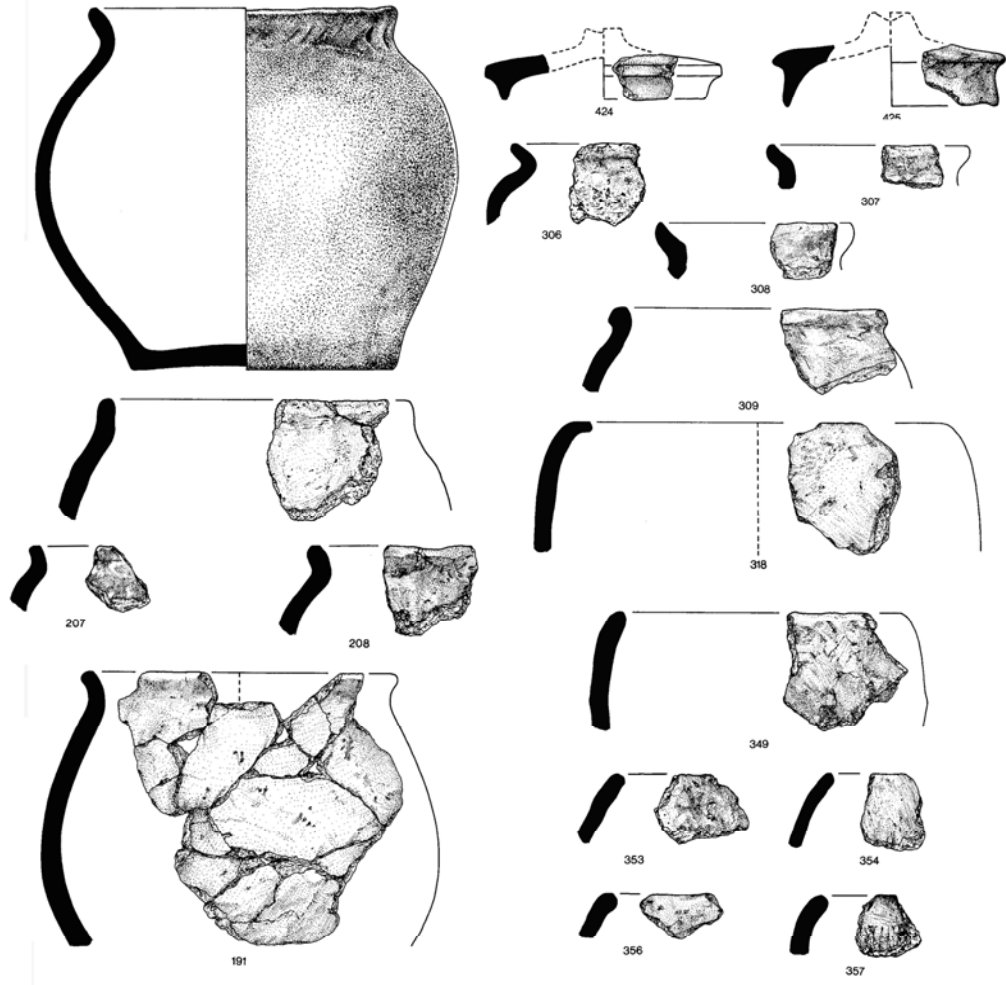

(nach Spors - Gröger 1997)

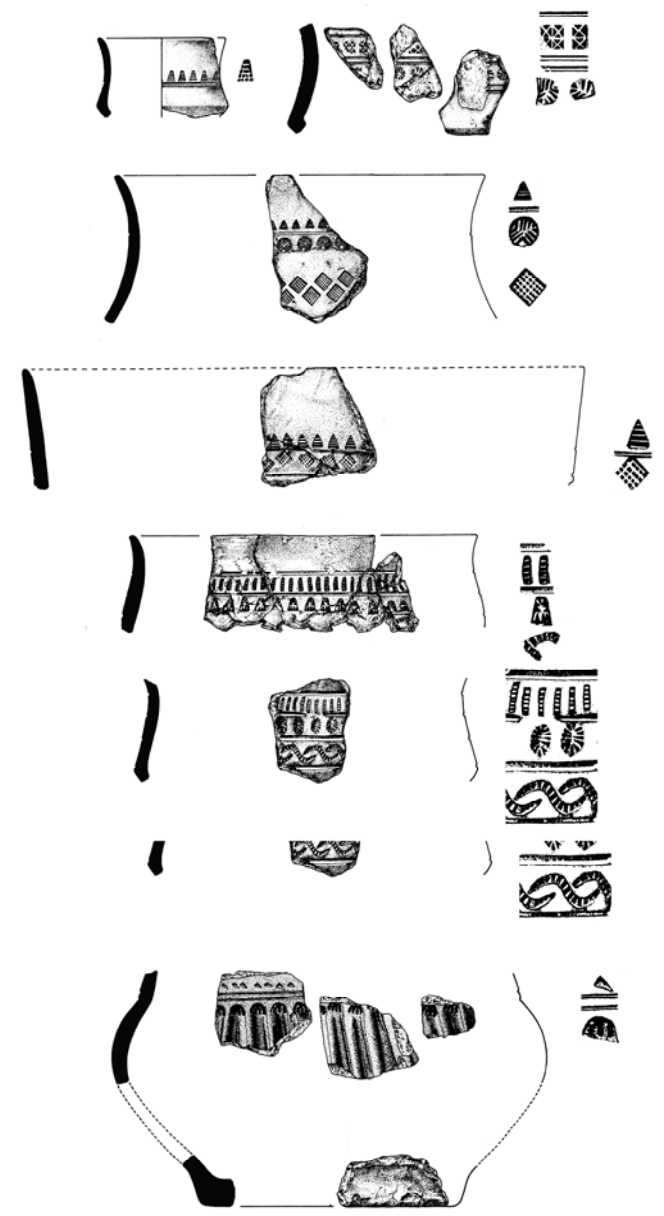

handgemachte Feinkeramik (nach Spors 1997)



14

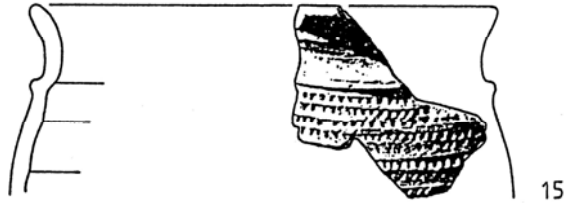

15

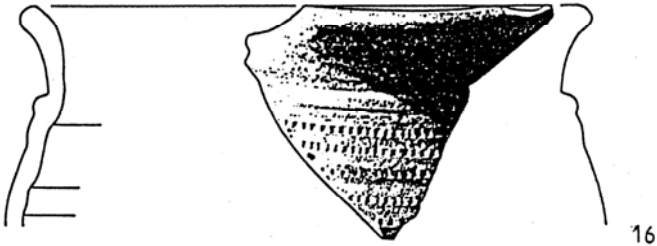

16

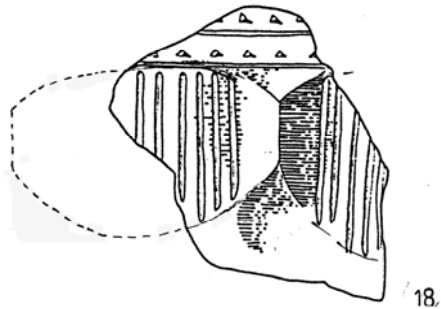

18.

Grubenhäus 1

Ladenburg a.N. (nach Schneid 1988)

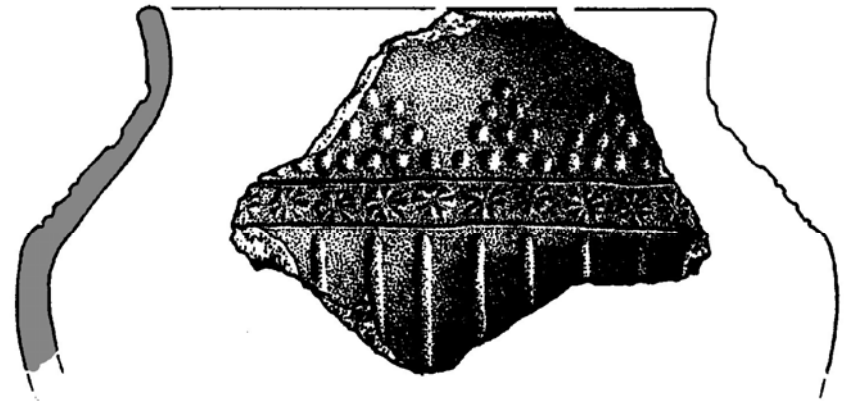

Heddesheim (nach König 2008)



Stempel
2:3

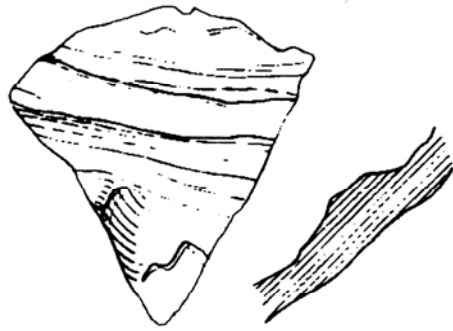

Rippengefäß
(nach Hübener/Lobbedey 1964) M 1:3

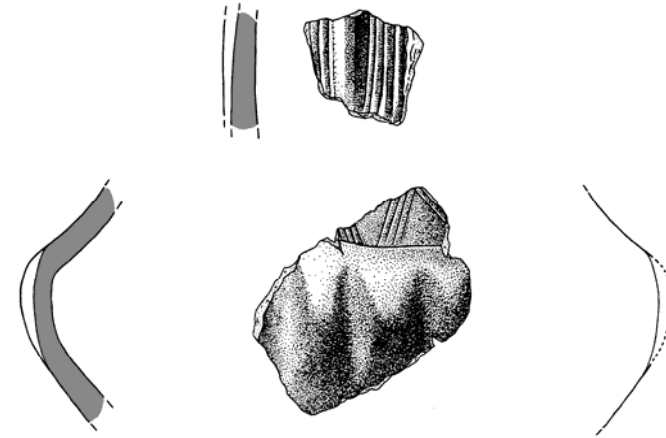

Rippengefäße Schleithem/CH
(nach Burzler u.a. 2002)

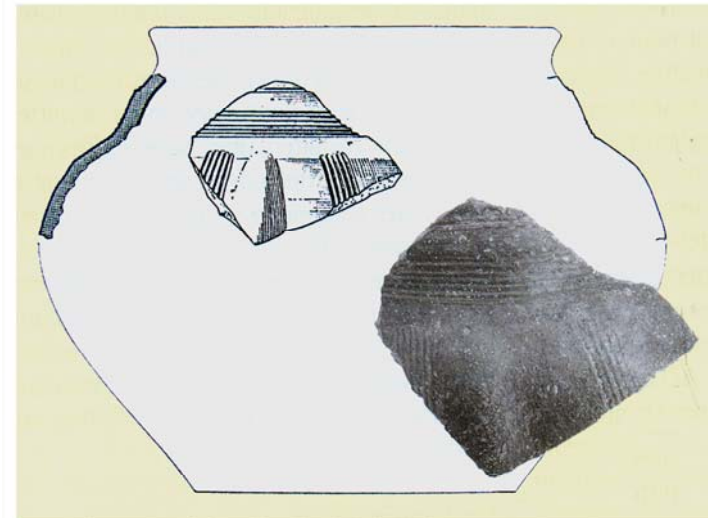

Rippengefäß Kirchheim/Teck
(nach Gross 2011)

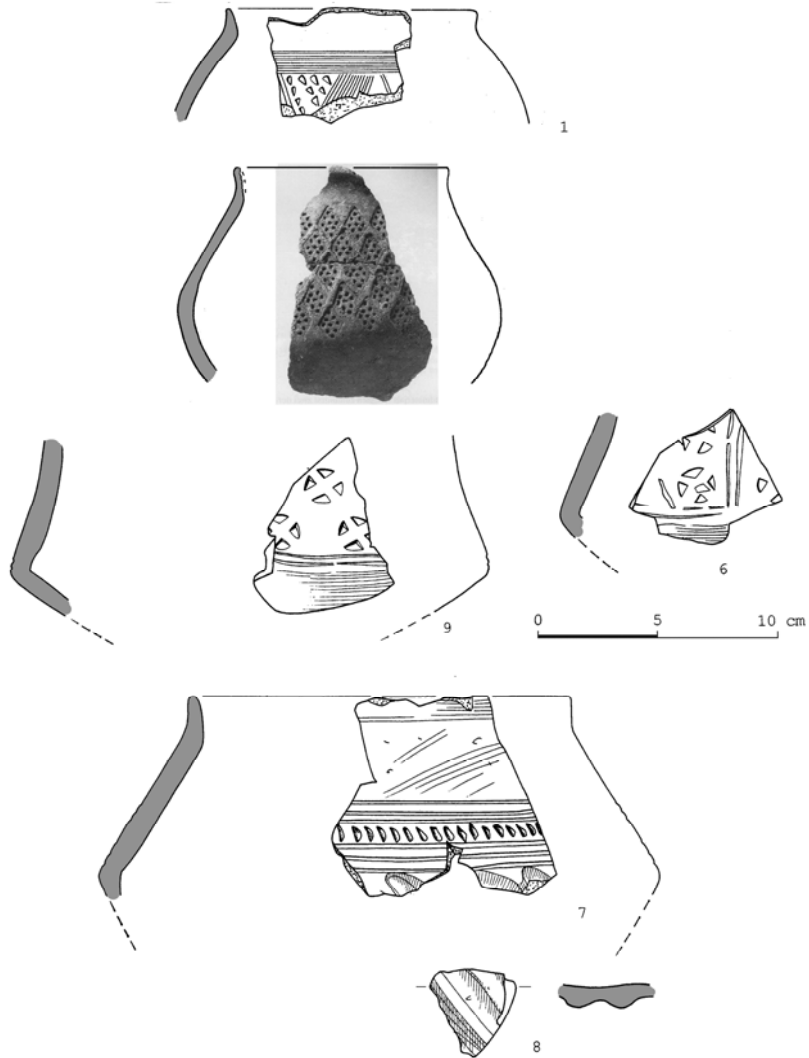

(nach Krause 1992, Gross 2006)

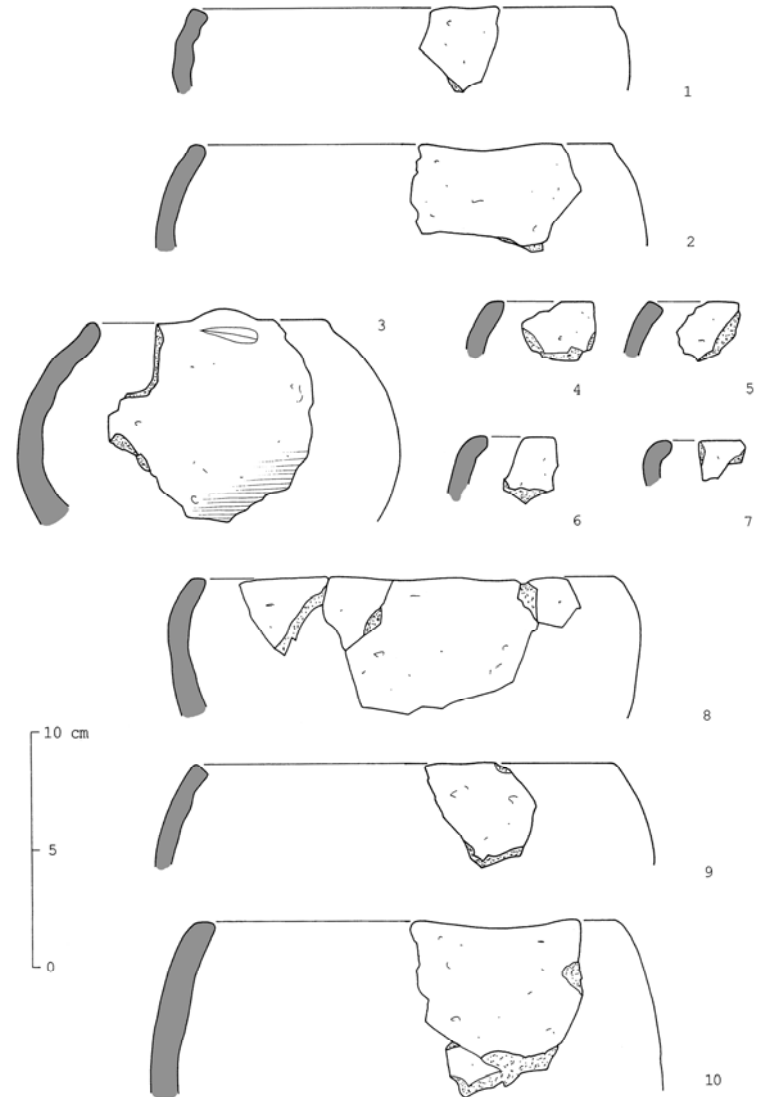

(nach Gross 2006)

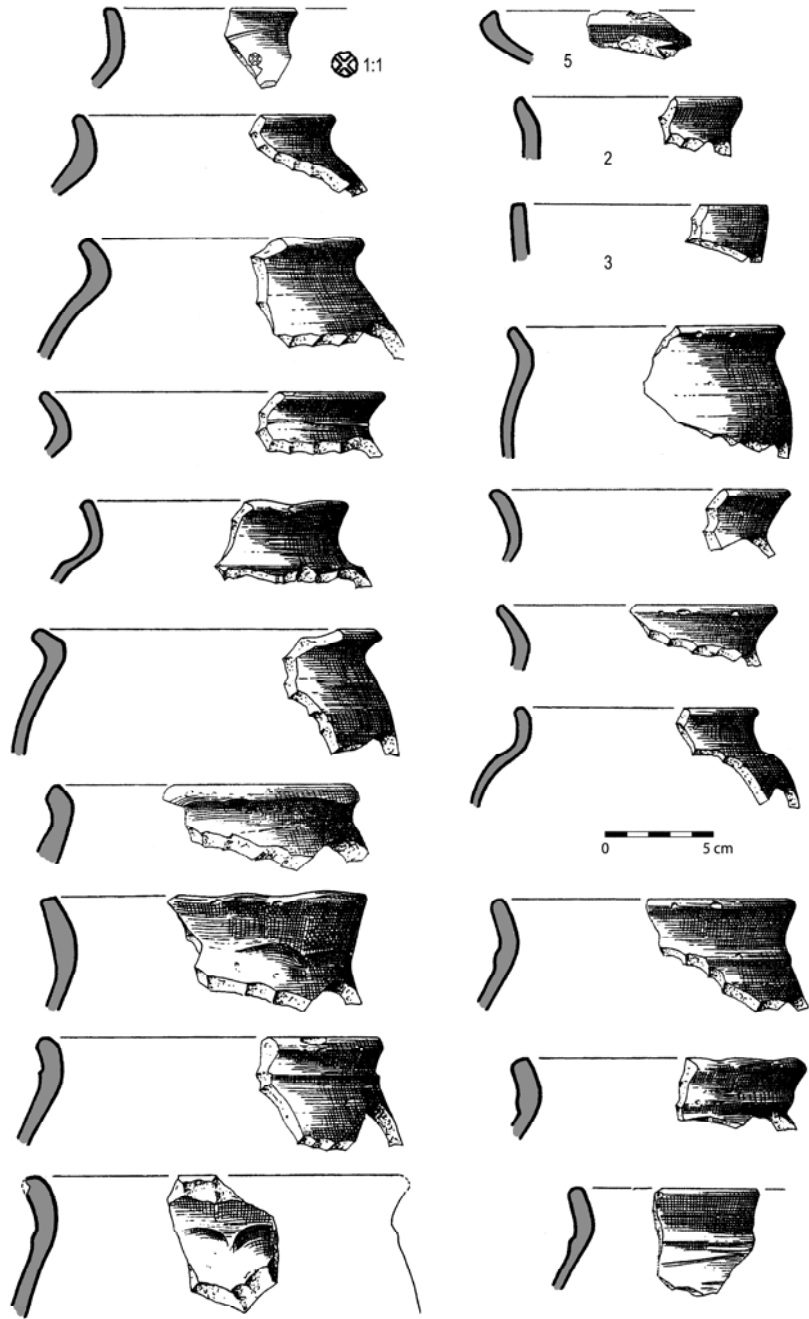

(nach Kottmann/Gross 2009)

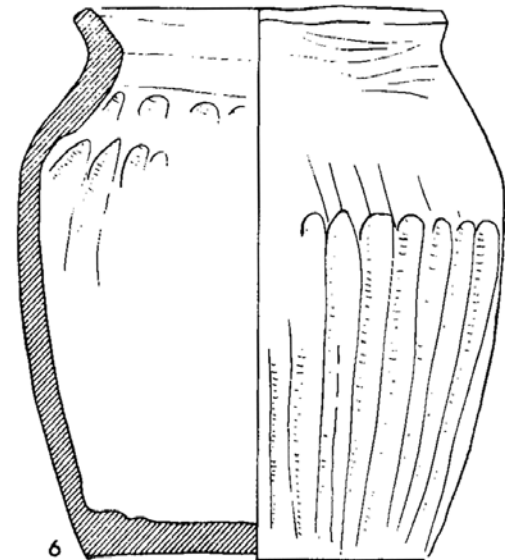

(aus: Hübener/Lobbedey 1966)

Ulm: Randscherben mit
„Nachdreh“-Spuren

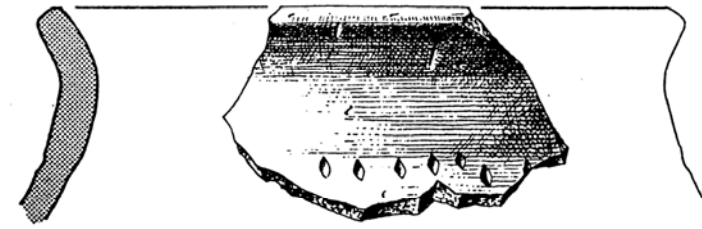

(nach Rieber/Reutter 1974)

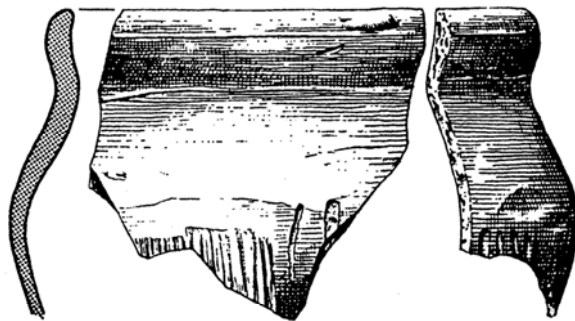

(nach Rieber/Reutter 1974)



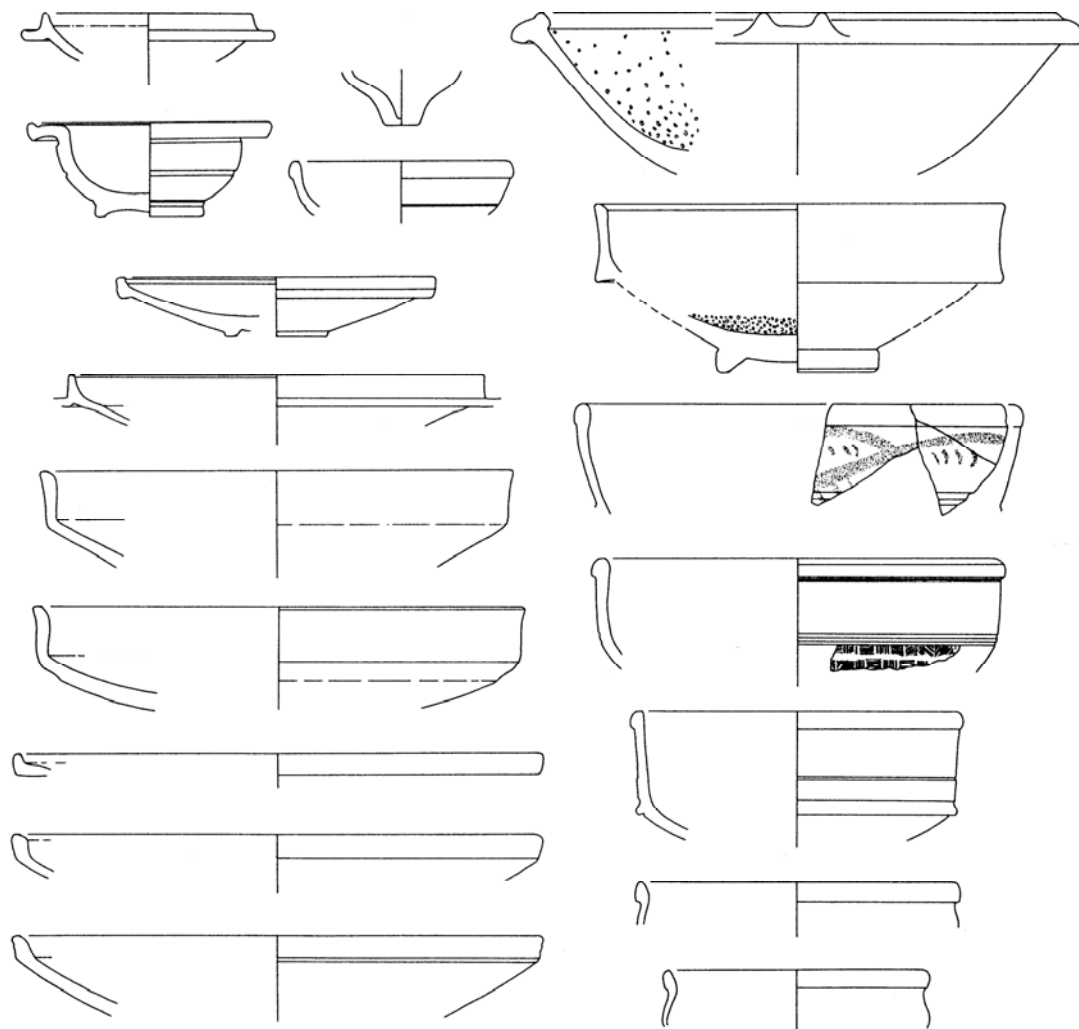

(nach Christlein 1978)

Abb. 71. Runder Berg bei Urach (Reg. 367). Gefäßformen der Terra sigillata bzw. der »rotgestrichenen Ware« des 5. Jh. aus der frühalamannischen Höhensiedlung. Maßstab 1:3.

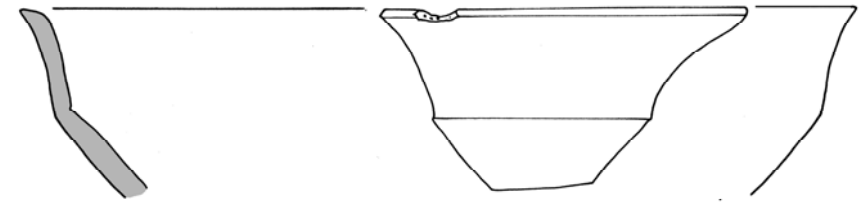

Mannheim-Seckenheim „Hermshheim“

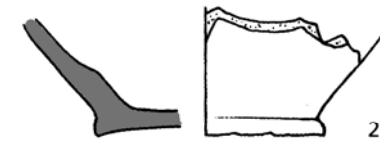
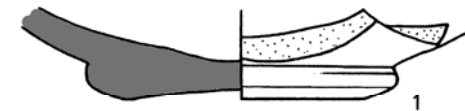

Mannheim-Wallstadt/Vogelstang

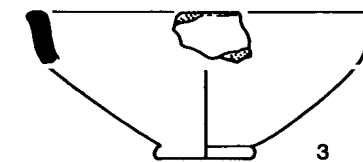
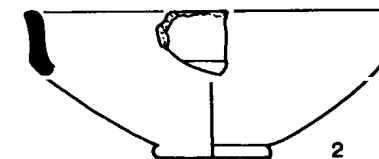

0 cm 10

Renningen
(nach Gross 1991)

Töpfereien in Südwestdeutschland

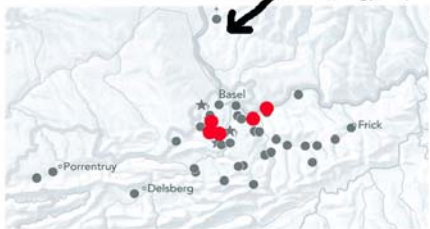
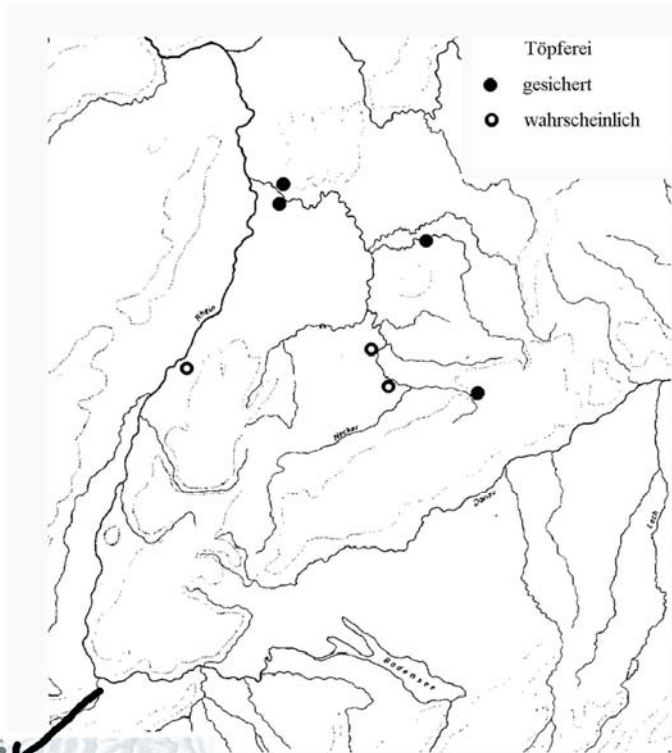

Detailkarte
NW-Schweiz
(nach Marti 2004)

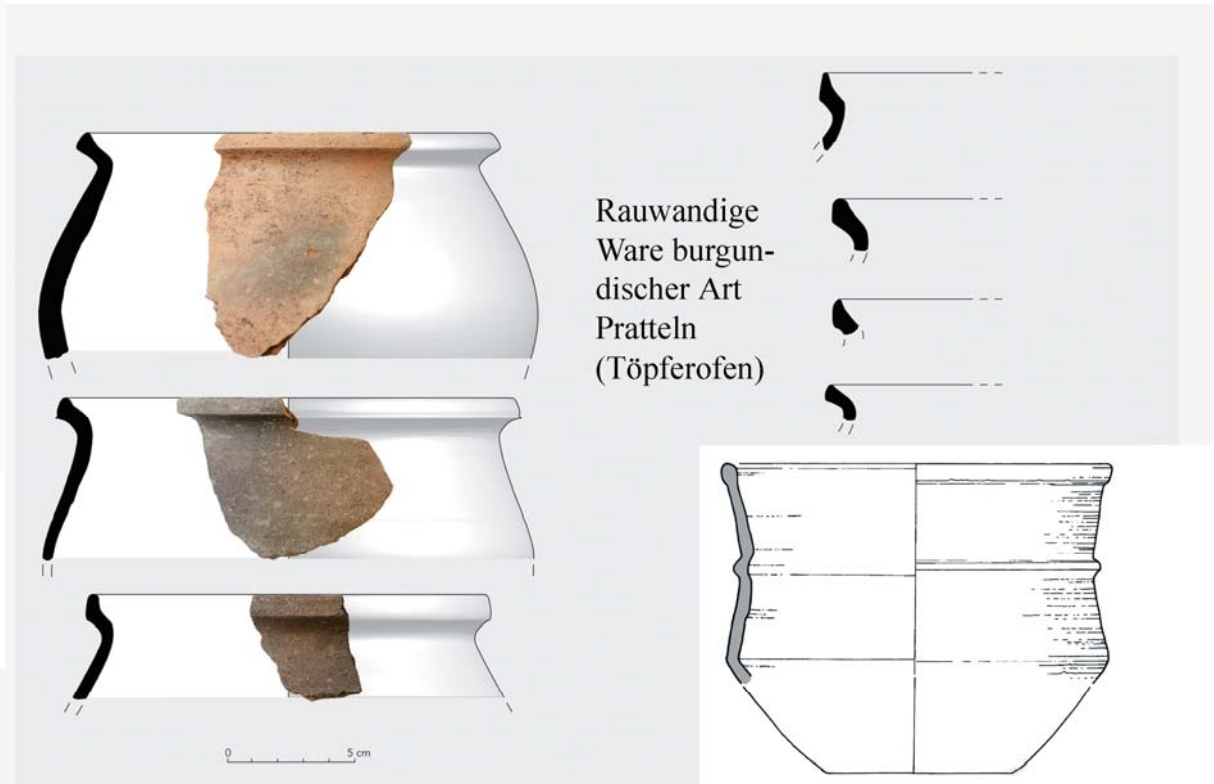

(nach Marti 2010)

„burgundischer Becher“ aus Kaiser-
augst (Töpferofen)
(nach Jahresbericht Augst /Kaiser-
augst 2008)