

The Lefkandi-Toumba building as a timber-framed structure

Alexandra Coucouzeli, Allan McRobie, Igor Kavrakov,
Dimitrios Raptis

Published on Propylaeum-DOK. Publication Platform for Classical Studies
Full-text server of Propylaeum – Specialised Information Service for Classical Studies,
Heidelberg University Library 2024.

This publication is permanently available at Propylaeum-DOK
<http://archiv.ub.uni-heidelberg.de/propylaeumdok/6299> (Open Access)
DOI: <https://doi.org/10.11588/propylaeumdok.00006299>

Bibliographic information published by the Deutsche Nationalbibliothek

The Deutsche Nationalbibliothek lists this publication in the Deutsche Nationalbibliografie; detailed bibliographic data are available in the Internet at <http://dnb.dnb.de>.



This work is published under the Creative Commons Attribution License CC BY-SA 4.0.

Propylaeum

SPECIALIZED INFORMATION
SERVICE CLASSICS

Published on Propylaeum-DOK – Digital Repository Classical Studies,
Heidelberg University Library 2024.

The electronic open access version of this work is permanently available at

<https://www.propylaeum.de>.

doi: <https://doi.org/10.11588/propylaeumdok.00006299>

Published by

Heidelberg University / Heidelberg University Library, 2024

Propylaeum – Fachinformationsdienst Altertumswissenschaften

Grabengasse 1, 69117 Heidelberg

<https://www.uni-heidelberg.de/de/impressum>

Text © 2024, by the authors

THE LEFKANDI-TOUMBA BUILDING AS A TIMBER-FRAMED STRUCTURE¹

by Alexandra Coucouzeli, Allan McRobie and Igor Kavrakov

University of Cambridge

with a contribution by Dimitrios Raptis

International Hellenic University

The article demonstrates that the building or megaron on the Toumba hill at Lefkandi (Euboea), dating from c.950 BCE, was a timber-framed structure, in contrast to the common view of it as a building with load-bearing walls. This raises the possibility that the walls, perhaps even parts of the frame and the roof, were still under construction, rather than fully completed as previously assumed, when the building was buried under a mound. The reconstruction of the building as a timber-framed structure, as well as an analysis of the manner of production of its wooden elements and a structural analysis intended to test the integrity of the frame point to a sophisticated and solid structure, giving us valuable insights into ancient wooden architecture and the complex rationale behind the adoption of designs of this kind as prototypes of later large-scale temples in Greece. There is no evidence that the timber frame suffered any significant structural failure, but if such failure ever occurred, it would most likely be a partial uplift of the thatched roof due to high winds.

INTRODUCTION

by Alexandra Coucouzeli

This article deals with the truly exceptional building on the Toumba hill at Lefkandi (henceforth, LK-T building), on the island of Euboea, dating from c.950 BCE (Popham et al. 1993). Located on the summit of a low hill (altitude 17 m a.s.l.), about 270 m from the seacoast, the LK-T building stands out from its Early Iron Age contemporaries by its size, design, and sophisticated construction.

We offer a new perspective, differing from that of the excavators, suggesting that the LK-T building was a timber-framed structure, i.e. a structure where the walls served a non-loadbearing function, and the weight of the roof was carried entirely by posts, forming the main elements of a wooden framework. A new, detailed reconstruction of the timber frame of the building and its production stages is proposed, while the issue of the building's structural integrity is also addressed. Additionally, Appendices 1-5 deal with the following issues: what exactly is a timber frame structure and how the LK-T building fits into the broader context of wooden frame architecture among various archaeological and ethnographic examples from Greece and around the world (Appendix 1); the species of wood likely to have been used in the building and the taper of the centre posts (Appendix 2); the possible local unit of length, the building's dimensions, and construction details of the reconstructed timber frame (Appendix 3); the reconstruction of a staircase, a loft, and a mezzanine in the building's interior (Appendix 4); and engineering calculations relating to structural aspects of the building (Appendix 5).

A brief description of the building

The LK-T building presents a megaron plan ending in an apse at its west end and being accessible from the east – an opening or ‘secondary doorway’ in the south wall (Popham et al. 1993, 5-6, 13, 43) is open to interpretation (see *infra*). In its present state, following the damage it suffered in modern times (Popham et al. 1993, 1-3, 34), the building comprises, in succession, a shallow Porch, an East Room (ER), a Central Room (CR), two Square Rooms (SRs) – the North Room (NR) and South Room (SR) – on either side of a corridor (West Corridor), and an Apse Room (AR) (Fig. 1). Towards the middle of the building, in the CR, the rich double burial of a warrior accompanied by his female companion and four horses was found.

The walls consisted of a socle (c.1.15-1.30 m high) made of (mainly) coarse gray marble, in rubble masonry, surmounted by mudbricks of a light brown colour and a gritty texture up to a maximum height of four courses. The walls were preserved at markedly different heights, varying (in the places unaffected by modern damage) from c.0.50 m to c.1.60 m.

¹ This article was presented under the title ‘Building techniques in Iron Age Greece: The Lefkandi-Toumba building as a timber-framed structure’ at the International Conference ‘Craft and Production in the European Iron Age’, Magdalene College and McDonald Institute for Archaeological Research, Cambridge, 25-27 September 2015.

A prominent feature of the building, which we will focus on, is the large number of timber posts that compose it and which, after decaying, left their clear imprint in the fill of the specially dug pits into which they had been set or their wood residue at or above floor level. Thus, a series of posts of round cross-section, several of which survive, were set on the long axis of the building (average diameter: 0.222 m) dividing it into two aisles, while a double series of posts of rectangular cross-section (average width: 0.22 m; average thickness: 0.072 m) (Table A3:1) ran all along the inner face of the exterior walls and around the west, north and south sides of the building, forming a veranda – a forerunner of the peristyle (or *pteron*, *peristasis*) of Greek temples and the earliest attested example. Finally, there is a series of post pits across the ER and another across the AR.

Including the veranda, the LK-T building would have measured 48.30 m x 13.80 m, its reconstructed length – based on a geometrically generated triple-contour ellipse drawn for the ideal contours of the apse wall and its surrounding veranda, which are mostly missing – being three and a half times its width throughout most of the building (except at the west end, where the building narrowed), as shown in Fig. 2 with Inset A (the dimensions shown in Fig. 2 and in the following figures are multiples or subdivisions of a foot of 0.30 m, a plausible local unit of length – see Appendix 3: I, II). This is therefore the largest Early Iron Age building and the largest megaron known to us from ancient Greece. With its monumental size and megaron plan, as well as its surrounding posts in the veranda and its eastern orientation, the LK-T building is strongly reminiscent of later Greek temples.

A blocking wall runs across the façade of the building. Against the long walls, on the outside, there were ramps made predominantly of mudbricks of different colours and a soft texture, on a base of earth or pebbles. The interior of the building was filled mostly with earth, often containing mudbricks similar to those of the ramps, as well as stones, pebbles,

remains of reeds or rushes, and other debris. Fill and ramps together formed a mound over the entire site.

The building has yielded a scarcity of finds, while there is no evidence that it was ever occupied. In fact, there are signs that it was left incomplete, the most obvious being the following: an interrupted wall plastering- or floor laying operation within the SR (Popham et al. 1993, 24, 97-8); differences in the plaster coverage of some walls in the building's interior (areas of thick, finished plaster *vs* areas of patchy and thin, incomplete plastering) and complete absence of plaster from other walls (Popham et al. 1993, 6, 9-10, 13-14, 23, 25, 42, 97, pls 7, 8, 31*b*, 31*c*); clay floors covering only part of a room or being patchy, thin and poorly preserved, ill-defined or even totally absent (Popham et al. 1993, 12, 15-16, 22-5, 98, pl. 9); and lack of steps from what can safely be identified as a staircase in the north-east corner of the CR (cf. Popham et al. 1993, 98; see Appendix 4: I).

In addition, there are signs of damage or disturbance to the building as well as some 'oddities', which are the following: in the SR, the north wall presents a 'severe cant' in two opposite directions on either side of the doorway (Popham et al. 1993, 24, 98, pls 25*a*, 26, 31*a*, 37-West Section); in the NR, the part of the south wall to the west of the doorway is devoid of its inner face (Popham et al. 1993, 23, 98, pls 23, 24*a*, 26, 29*d*); patches of (decayed) reeds or rushes from the roof lying on the floor (and in the fill) of the building in several places (Popham et al. 1993, 18, 31, 99, pl. 12: level 4 and pl. 37: East Section); and a number of skewed or misaligned wall- and veranda posts in the eastern part of the building² (Fig. 1).

Interpretation of the building and its structure

The LK-T building has been identified by most of its excavators as a Heroön, a funerary building that would have been planned and initiated by (or erected in honour of) the warrior who was sumptuously and heroically buried in it, and therefore constructed, in imitation of a 'princely' residence, largely or entirely after the death of that individual (Popham et al. 1982; 1993, 49, 100). However, the Heroön hypothesis has been disputed, starting with Calligas, another excavator, and myself included, in favour of an interpretation of the building as the residence of the 'warrior-king' (or *basileus*) who would have ultimately been buried in it.³

² Posts N3, S3, VS4, VS5, VS8, VS9 and VS11 are skewed; post N4 is misaligned, being located *c.*0.2 m from the wall (Popham et al. 1993, 28, 39, table 2, pl. 38).

³ Calligas 1984-1985; 1988; Fageström 1988, 59-60, 129; Whitley 1991, 185-6; Crielaard and Driessen 1994; Mazarakis-Ainian 1997, 55; 2006, 191; 2012, 78-9; Coucouzeli 1994; 1999; 2004.

In Coucouzeli 1994, it was proposed that the LK-T building was an unfinished longhouse intended to be inhabited by a large, corporate kinship group, probably a clan, under the leadership of a powerful chief,⁴ upon whose death the site would have been suddenly abandoned and buried under a mound. It was further proposed that in this setting, as a longhouse, the building had a CR likely designed to include two rows of antithetical square rooms (SRs) or cabins on either side of a central corridor to serve as the private, living apartments of the nuclear families (or *oikoi*) constituting the longhouse group: ten more rooms can be reconstructed to the east of the two existing SRs and of similar size to the latter, twelve in all, the northern row ending at a sufficient distance from the staircase in the CR to provide access to a *sottoscala*; a mezzanine above the cabins would serve the storage needs of each family (Fig. 3; Appendix 4: I, III, Figs A4:1, A4:2, A4:4). Although the reconstruction of two rows of cabins is not a prerequisite for identifying the building as a longhouse, it is recommended for two basic reasons: first, it addresses the unusual presence of the two SRs by making them part of the CR⁵ and giving the building a neat tripartite division (front-central-back room), such as is familiar to us from other megara but is also characteristic of longhouses; and, second, it provides the additional cross walls that would be needed to brace the long exterior walls of the CR and prevent them from collapsing.⁶ For these reasons, in what follows, the SRs will be considered as part of the CR. Finally, it was suggested that the LK-T building was a timber-framed structure (Coucouzeli 1994, 33-59), and this is the issue we will focus on here, with all the implications that it entails. We will put forward a new reconstruction of the LK-T building, as a timber-framed structure, differing significantly from previous reconstructions, which presuppose the existence of load-bearing walls.

The excavators reconstructed the LK-T building assuming *a priori* that it was a structure where the walls, rather than the posts, supported the load of the roof, i.e. they had a structural character. Thus, the wall posts were interpreted as ‘stabilisers’ of the veranda posts (by connecting them to the wall via horizontal beams crossing the wall at about the height of the eaves) and a timber plate placed on top of the walls to support the roof rafters, and therefore as serving ‘to connect all the main elements of the roofing system and also the walls’ (Popham et al. 1993, 47-9, fig. 1, pl. 28).⁷

The excavators’ reconstruction of the building as a structure with load-bearing walls has generally been taken for granted by other scholars, with some of them proposing different, equally questionable, reconstructions. Fageström’s reconstruction of the building showing the wall- and veranda posts bending inwards and crossing at the ridge beam (Fageström 1988, 60, fig. 46) is contradicted by the existing evidence. Herdt – who, incidentally, pointed out the LK-T building’s similarity to European Neolithic longhouses – went even further: asserting that ‘there is no valid structural interpretation [for the wall- and veranda posts] as the wall is solid enough to fulfil any structural duties by itself’, he put forward a reconstruction of the building, whereby the veranda posts are detached from the building and instead form a fence surrounding it (Herdt 2015; see also Wilson Jones and Herdt 2022); we address Herdt’s argument in Appendix 2: II and Appendix 5: III.b.⁸

⁴ Depending on the status of its leader, a longhouse can start at a length of 10.50 m and reach great lengths, such as c.60 m (Neolithic and Bronze Age Europe – see Appendix 1: B.2.1), 75-120 m (North America) or even attain lengths of 180-660 m thereby constituting a ‘hamlet’ or even an entire village (Northwest Coast of North America, Borneo) (Coucouzeli 1994, 319, 329-30, 332, 335, 340); this is in reply to Mazarakis-Ainian 2006, 190-91.

⁵ This is also suggested by the fact that the partition wall between the two SRs and the AR is 0.60 m thick, as are the partition walls between Porch-ER and ER-CR, unlike the eastern walls of the NR and SR, which are only 0.50 m thick.

⁶ J. Moreira, pers. comm. A similar point is made by Herdt (2015, 207).

⁷ In an earlier publication, one of the excavators expressed the view that, in contrast with lightly built, wattle-and-daub walls, which need wall posts ‘to provide rigidity and stability to the walls’, ‘[stone and mudbrick walls] do not need wall posts to ensure their own stability and/or to help carry the roof load and at Lefkandi in particular, where the walls of the Toumba building were c.0.60m thick and had a substantial stone socle, posts only c.0.008m thick can hardly have given much additional support’, concluding that the firmly embedded wall posts at LK-T had the function of anchoring the (timbers of the) light-weight, thatched roof directly to the ground, so as to resist the lateral and upward forces exercised by the wind, by being attached to a timber plate running on top of the (load-bearing) walls (for the support of the rafters) (Coulton 1988, 59-63). However, such a view is based on what might be called a wall-centric or ‘toichocentric’ perspective, which considers the walls as the determining structural factor (for other examples of this kind of perspective, see Appendix 1: B.2.2, n. 24, 36, 37, 40, 42, 44; Drerup 1969, 108-9), and the two types of walls mentioned and contrasted with each other are actually both part of timber frame buildings (see Appendix 1, *passim*).

⁸ Crielaard and Driessen (1994, 255-6 n. 24, 267) raised the possibility of the existence of a timber framework in the LK-T building, while nevertheless adhering to the excavators’ view of the role of the wall posts as ‘stabilizers’ of the veranda posts via horizontal beams passing through the mudbrick walls.

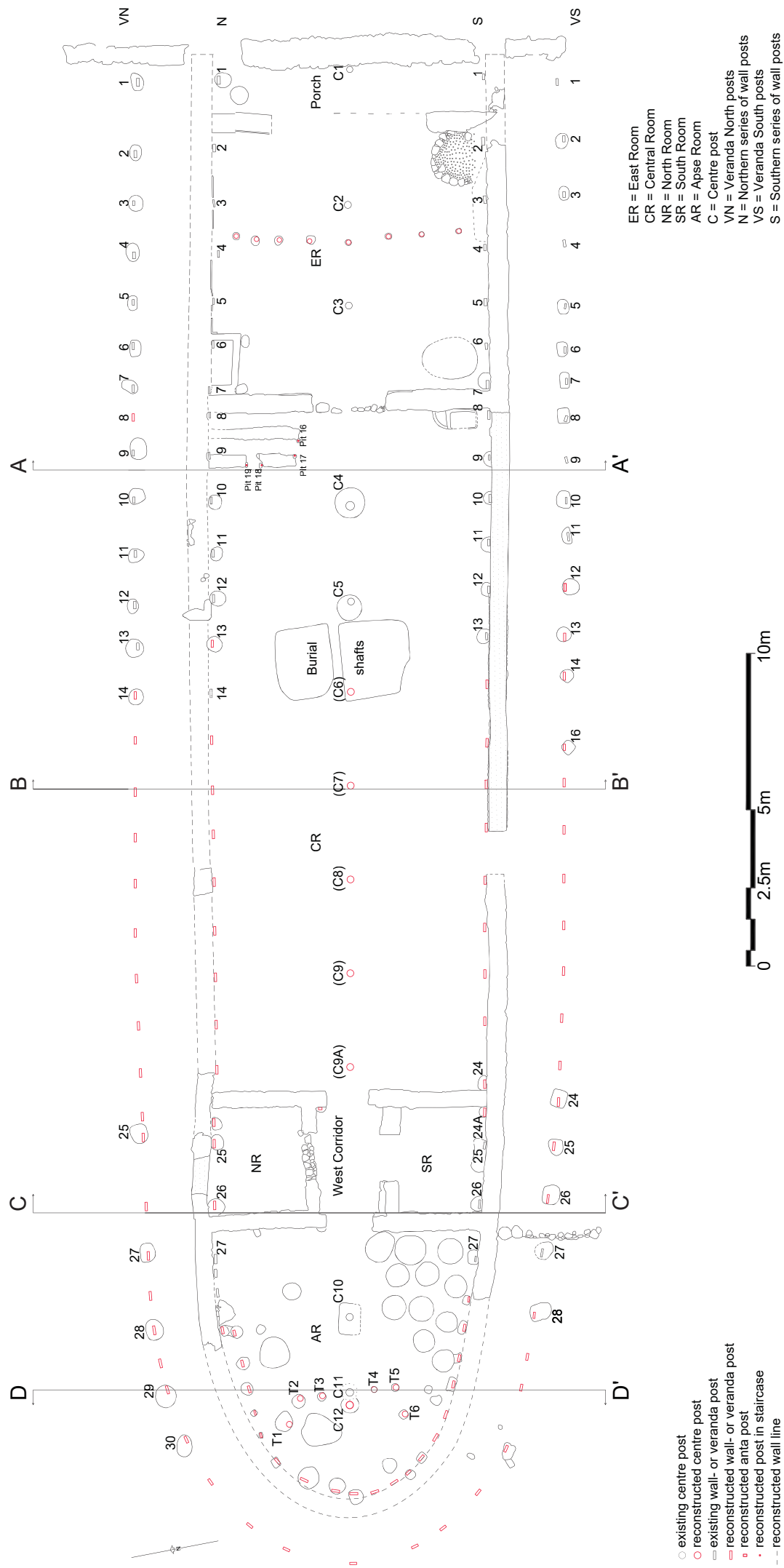
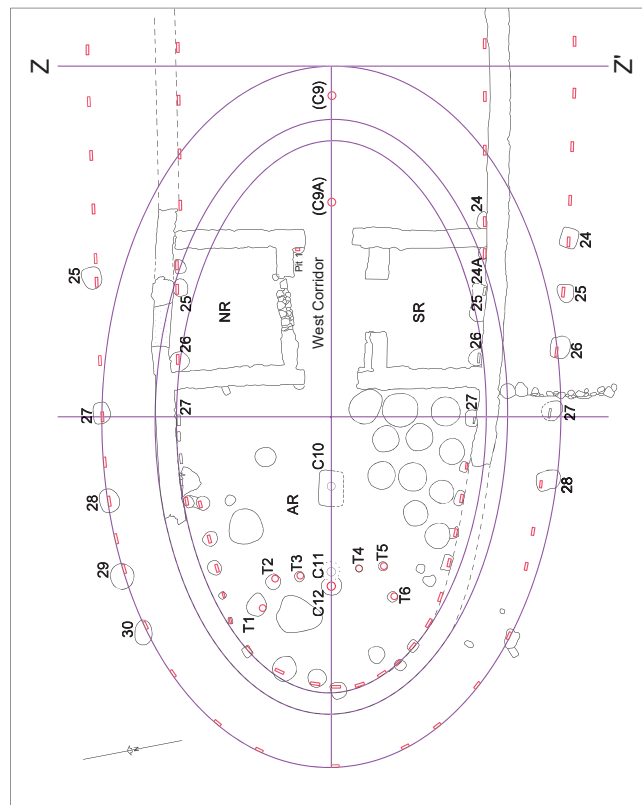
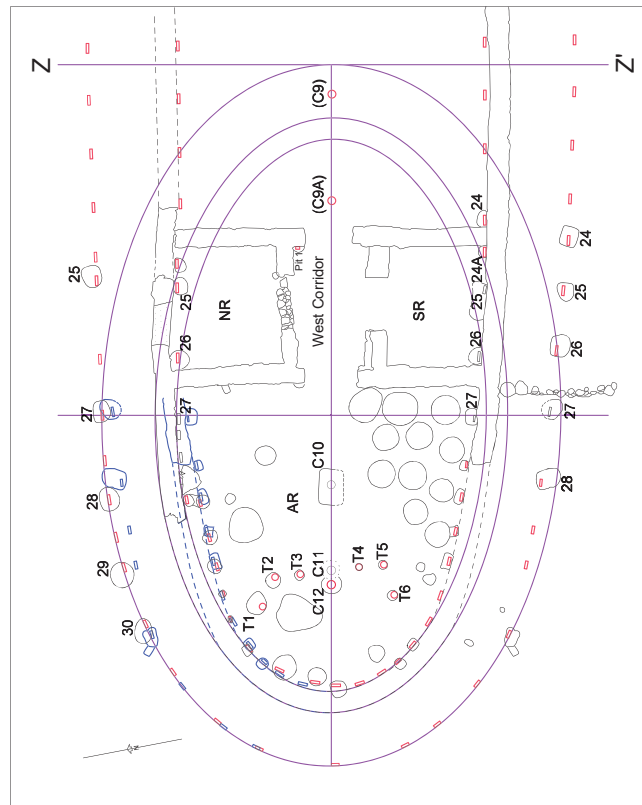
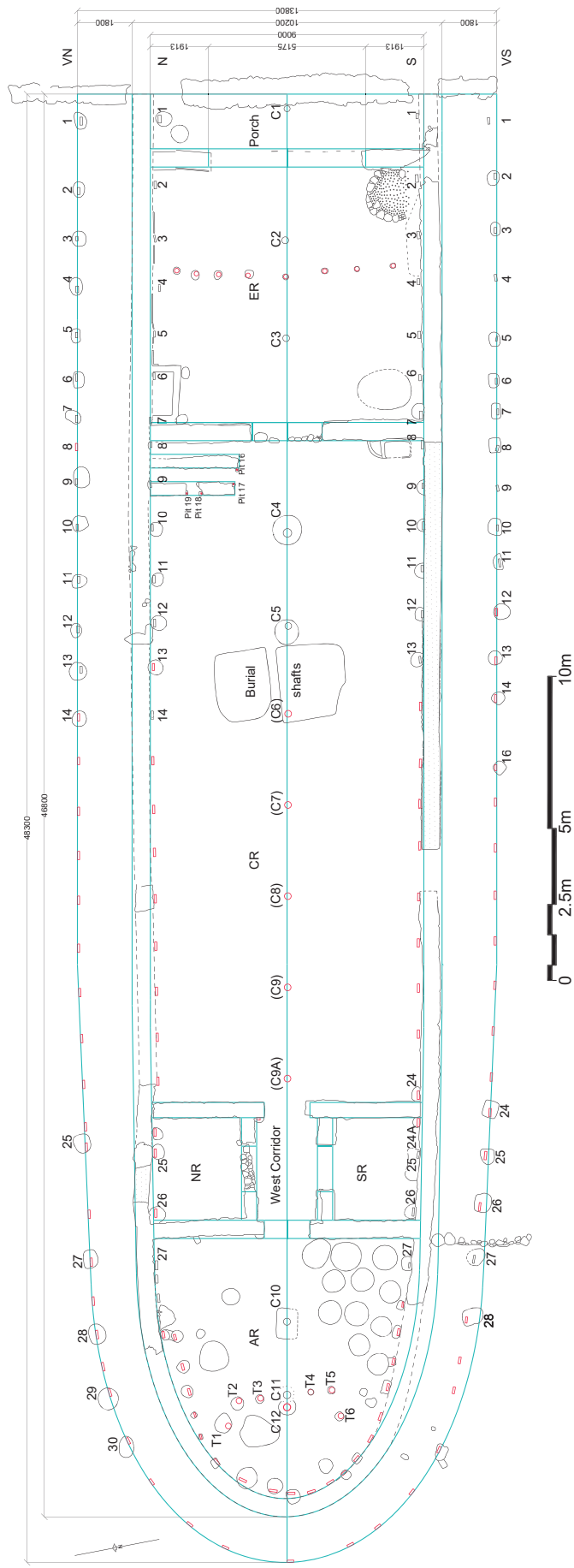


Fig. 1. General plan of the LK-T building.



Inset B

Inset A

Fig. 2. Idealised plan of the LK-T building (in black). Inset A: A geometrically generated triple-contour ellipse (in green) superimposed on the existing plan (in black). Inset B: The outline of the wall posts in the southern half of the AR projected onto the northern half of the AR (in blue), resulting in a largely symmetrical pattern.

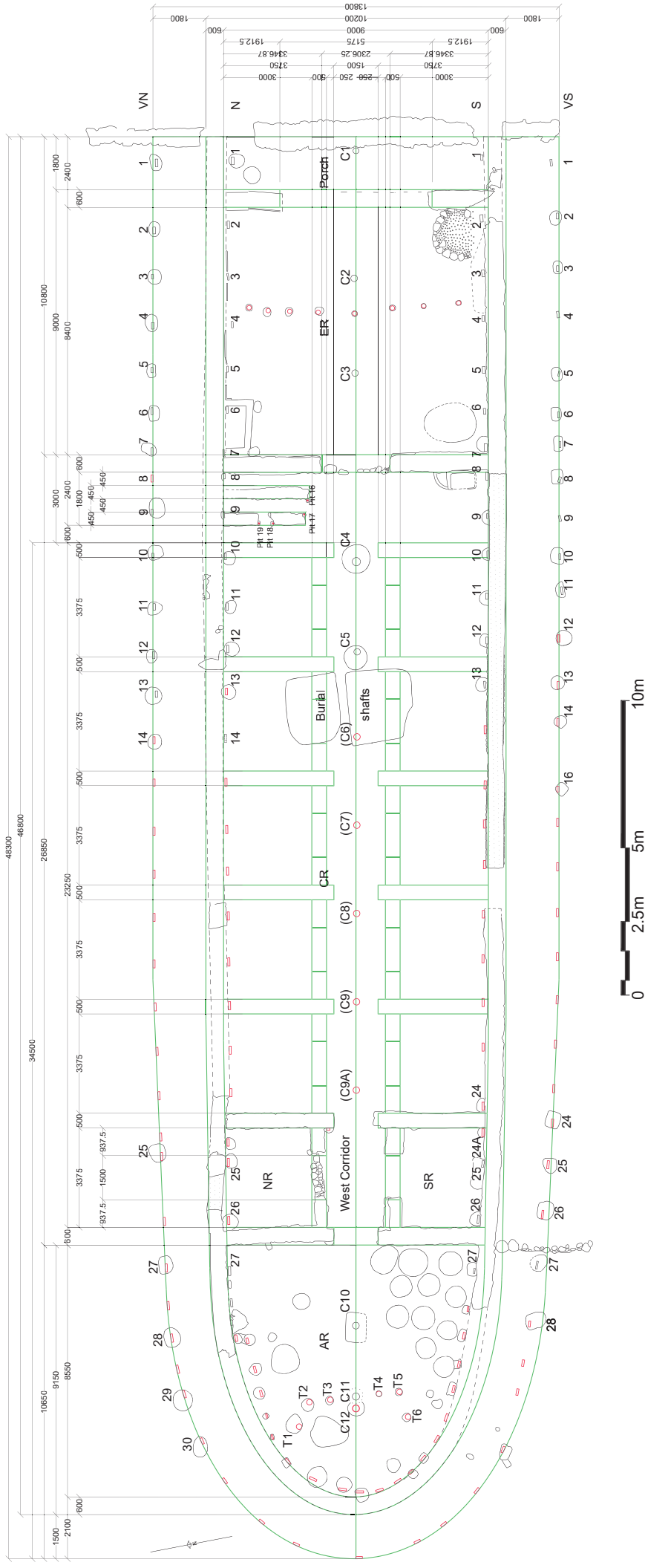


Fig. 3. Reconstruction of the idealised plan of the LK-T building with two rows of antithetical rooms in the CR (in green) superimposed on the existing plan (in black).

The *a priori* assumption of the existence of load-bearing walls in the LK-T building inevitably led the excavators to a series of hypotheses regarding the building, which are as follows.

Hypothesis 1: The erection of the walls preceded that of the posts, the sequence being: construction of the walls – setting up of the posts – installation of the roof.

Hypothesis 2: The walls were built to their full height and ‘the basic construction including the roofing had been completed’.

Hypothesis 3: During the process of abandonment of the building, a large part of it must have been dismantled, in order to facilitate its filling and to form a low and regular mound or tumulus over it. Thus, the whole roof was removed; the upper parts of the mudbrick walls were dismantled for use in the ramps; the walls at the east and west ends of the building were dismantled to a greater extent, also affecting their stone socles; and the posts were partly or wholly removed (Popham et al. 1993, 29, 38, 44, 49, 52-5, 97-8, 100).

Our reconstruction of the LK-T building as a timber frame structure challenges the above-mentioned assumptions about the building’s structural character, construction process, state of completion and abandonment process.

I. THE LK-T BUILDING AS A TIMBER FRAME STRUCTURE

by Alexandra Coucouzeli

Against the background of the information provided in Appendix 1, one can safely identify the structural system used in the LK-T building as a frame construction or a skeleton system (as opposed to a mass construction or massive system, as it has hitherto been identified) and the building itself as a timber frame structure. As shown in Appendix 1, timber frame construction was used in Greece from prehistoric times to the Archaic period, including in temple architecture. The LK-T building is the earliest known Early Iron Age timber frame structure, which, as we will see, implies a high degree of sophistication at this early period.

The signs that the LK-T building was a timber frame structure are as follows. First, the series of posts that ran along the inner faces of the exterior walls of the building is the most convincing indication that the walls had no structural function, i.e. they were not loadbearing, and that the wall posts acted instead as load-bearing elements in a timber frame designed to support the weight of the roof. The wall posts of the LK-T building are indeed a clear example of *mesodmai* (μεσόδμοι), mentioned in Homer in close connection with the walls as being *sprinkled with blood* during the slaying of the suitors in Odysseus' megaron (*Odyssey* 19, 37; 20, 354).⁹

Second, all the posts were related to each other by two kinds of alignment, which strongly suggest that there was a structural connection between them for the purpose of carrying the roof. Thus, if one leaves aside the west, curved end of the building, where the different geometry of the roof necessitated different roofing arrangements (*infra*), and focuses on the rest of the building, one notices that all the posts were carefully aligned with each other longitudinally, i.e. in the direction of the long axis of the building. The longitudinal alignment of the centre posts was an arrangement to carry the ridge beam or rather, given the great length of the building, the series of ridge beams of a gabled roof, i.e. a roof comprising two sloping surfaces on either side of a ridge and at least one flat, triangular end or ‘gable’ (Brunskill 1992, 93, figs 2, 4, 60g, 69), while the longitudinal alignment of the wall- and veranda posts implies that they carried at their top a series of ‘plates’ (also known as ‘top plates’ or ‘wall plates’) linking them together (longitudinal linkage) (Fig. 4¹⁰); both the ridge beams and the plates would have tied the building in the longitudinal direction (Sobon and Schroeder 1984, 23). At the same time, all posts were also *generally* aligned with each other transversely, i.e. perpendicularly to the longitudinal axis of the building, in a way such that there is (a) a *one-to-one correspondence* between the intervals of the wall posts and those of the veranda posts; and (b) a *one-to-two correspondence* between the intervals of the centre posts and those of the wall- and veranda posts. The intervals vary (see Popham et al. 1993, table 3), with those of the wall- and veranda posts at the east part of the building averaging *c.* 1.5 m (Popham et al. 1993, 27-8); a typical section across the timber frame is that

⁹ See Drerup (1969, 109), who identifies the *mesodmai* as ‘eingelassenen Wallpfosten’.

¹⁰ Since this and the following figures of the reconstruction of the building have been drawn in Auto-CAD, it is necessary to allow for irregularities and imperfections in the actual appearance of the building. All figures in the main article were drawn by Alexandra Coucouzeli.

involving the interval between centre posts C4-C5, equal to 3 meters,¹¹ to which corresponded two intervals of 1.5 m between the wall- and veranda posts on either side (Fig. 5). The general transversal alignment of all the posts, in conjunction with the large size of the intervals between the wall- and veranda posts, strongly suggest that all the posts participated in the carrying of the roof's 'principal' rafters (Fig. 6), with further, 'intermediate' or 'common' rafters placed in-between (Fig. 6: Insets A, B, C, D and Appendix 3: III). The actual manner in which this was done is made apparent by the fact that the posts present a slight but consistent mutual staggering: this implies (a) the use of *two separate rafters* in each roof-span: an upper rafter (ridge to wall-post plate) and a lower rafter (wall-post plate to veranda-post plate), which is expected, in view of the large spans occurring across the building (the horizontal span of the roof, between outer faces of plates over wall posts, is *c.* 9.0 m – see Fig. 7); and (b) the use of *adjacent* rafters resting on the ridge beam and on the wall-post plates, over the wall posts (see Figs 6, 7).

Third, all the posts were firmly embedded in the ground, in pits carefully dug for this purpose¹² – a 'striking feature' of the building, according to the excavators (Popham et al. 1993, 58) – to an average (ascertained) depth (or depth of pit) of 0.58 m for the wall- and veranda posts and to an average (ascertained) depth of 1.44 m for the centre posts (Table A3:1) (Fig. 7). This implies a structural function for the posts: earthfast posts act as pile foundations to anchor the timber frame to the ground and ensure its structural balance and resistance, primarily to lateral wind forces. It is the simpler arrangement for setting up the posts of a timber frame (compared to the technologically more advanced arrangement of setting the posts off the ground, which requires more complex structural solutions) and can be extremely effective, provided that the posts are buried to the correct depths (see Appendix 1: A.2; Appendix 5: II.b; *infra*, Section IV).

Therefore, the posts of the LK-T building were the 'supporting elements' of a 'skeleton' system; they formed part of an 'active' frame, which concentrated the loads of the roof and transferred them to points in the ground (see Appendix 1: A.2). As the main vertical components of the frame, these load bearing, embedded posts were intended to play a crucial role in the overall strength and wind resistance of the timber structure. Consisting of either 'columns', i.e. timbers of a round cross-section (centre posts) or, in their majority, of 'squared timbers' (wall- and veranda posts), which represent the best choices in timber frame architecture, compared to 'poles' or 'riven timbers' (see Appendix 1: A.2; *infra*, Section II), they imply a high-status building; it is important to note in this regard that the LK-T building predates by at least 250 years a temple which exhibits the same basic construction principle, using squared timbers embedded in the ground, and which is the Archaic temple of Poseidon at Isthmia (Appendix 1: B.2.2.3). By contrast, the masonry walls of the building were merely the 'bounding elements' of the skeleton system; being non-load bearing, they formed a permanent, protective envelope or cladding around the latter, isolating it from the atmospheric agents (see Appendix 1: A.2).

It naturally follows from the above that when the plan of the building was executed, the timber framework would have preceded the walls (even if only by a few hours), which must therefore have been constructed mainly from the outside, being erected in close juxtaposition to the timber frame/in close proximity to the wall posts' line in most of the preserved part of the building (with a few exceptions at the west end). Thus, the timber frame would have been built quickly, with the roof following closely – thereby also ensuring the necessary waterproofing for the construction of various inner features – and then, slowly, the frame would have been closed all around with the walls. Evidence that the walls were added *after* the timber posts were in place is provided (a) by the fact that several post pits ran partly under the walls, (b) by the fact that the wall plaster was only applied between the posts; (c) by a case where the wall plaster (and one expects the wall too, which no longer exists) was put in place in function of the wall post (N5) rather than the other way around, and (d) by the fact that at least one wall post (N9) and probably another (N8) were hidden behind internal transverse walls (Fig. 1), implying that the latter were constructed later.¹³ That the

¹¹ Popham et al. 1993, table 3: Interval between C4-C5, measured from centre to centre of post imprint = 3.02 m.

¹² The care with which this was done has already been remarked upon by the excavators as constituting a 'striking feature' of the building (Popham et al. 1993, 58).

¹³ Post pits running partly under the walls: S7, S9, S10, S11, S12, N8, N9, N13, N26, S24, S26; to these may be added Pit 1, which probably lay partly under the anta of the east wall of the NR (Popham et al. 1993, 22, pl. 23) and which must have been intended to receive a post with a structural function, such as to hold a beam carrying the joists of a mezzanine over the NR (Fig. 1; Appendix 4: III, Fig. A4:4). Cf. Fageström 1988, 60; Crielaard and Driessen 1994, 255 n. 24, 267. Cf. also the relative position of walls and posts in the Burnt House at Sitagroi and in the so-called 'Daphnephoreion' at Eretria, both of which were timber-framed buildings (see

position of the posts, like that of the walls, would have been previously delineated on the ground, is suggested (a) by the fact that in the northern half of the AR, the wall posts are largely symmetrical to those in the southern half, while the remaining wall posts as well as the veranda posts and the wall itself follow the outline of the triple-contour ellipse drawn for them (Fig. 2: Inset B); and (b) by the setting of the wall posts N7, N8, S7, and S8 closely on either side of the partition wall between CR-ER (Fig. 1). This arrangement also raises the question of the relative irregularity of the posts' intervals, which we will try to answer after examining the structure of the roof.

As already mentioned, in most of the building, except at the west end, the roof would have been gabled. More particularly, the 'prop-and-ridgepole' (or 'column-and-ridgepole') roof construction (see Appendix 1: A.2) would have been used, with the ridge beams and the plates tying the building in the longitudinal direction, i.e. providing longitudinal linkage to the axial and side posts, respectively (Fig. 7).

In principle, given the use of embedded posts acting like pile foundations (*supra*), the longitudinal linkage would have been sufficient for the carrying of this type of roof, rendering the use of transversal linkage in the form of a series of crossbeams acting as cross-bracing essentially redundant (see Appendix 1: A.2, B.2.1-Danubian Neolithic houses). Besides, a series of crossbeams would have provided extra help only if they were attached to the centre posts; but then, lashings would not have been so good to this effect, while, on the other hand, carved joints¹⁴ would have weakened the centre posts – since 'to cut a joint inevitably creates a weakness' – and would have created a load.¹⁵ In fact, the evidence suggests that the use of such a series of crossbeams is unlikely, since in no case is it possible to include all three interior posts arranged transversely (i.e. a centre post and two wall posts on either side) in an imaginary line with a thickness equal to 0.22 m (based on the average diameter of the centre posts and the average width of the wall- and veranda posts – Table A3:1), which would be that of a potential crossbeam attached to a centre post and sitting, along the rafters, on the plates running on top of the wall posts (cf. Appendix 1: B.2.1-Danubian Neolithic houses).¹⁶

There are, however, three areas where crossbeams would have been necessary and, at the same time, sufficient to brace the entire structure.¹⁷ The first two areas are those of the partition walls between ER-CR and CR-AR, where the intermediate (ridge-supporting) centre post had to be banned due to the presence of a doorway and replaced by a 'king post', i.e. a shorter vertical post supporting the ridge at a higher level, namely within the roof space, and standing upon the midpoint of a crossbeam (Fig. 4: 'king posts' K1 and K2); the crossbeams in these areas would have been carried at either end by the plates above the wall posts (Figs 8, 9). The squared timber jambs of the doors in the partition walls between ER-CR and CR-AR could have extended to the underside of the crossbeams reconstructed in these areas, since in frame construction, openings such as windows and doors are commonly incorporated into the entire structure, being useful for filling-in the frame with materials (Appendix 1: A.2).

The third area, which would have required a crossbeam, is immediately adjacent to the centre post C1: the crossbeam placed here and resting, like the others, on the wall plates would have supported, in conjunction with the crossbeam in the area of the partition wall between ER-CR and the wooden studs of a partition across the middle of the ER (Fig. 4), the floor joists and floorboards of a loft extending above the ER and the Porch and accessed via the staircase located in the north-east corner of the CR (see Appendix 4: II, Fig. A4:3). The three crossbeams could have been connected by diagonal struts or 'braces' to the wall posts on either side

Appendix 1: B.2.2.3). The excavators' explanation of some of the post pits running partly under the walls of the LK-T building as being due to the difficulty of cutting a perfectly vertical face for such pits, because of the friable nature of the conglomerate in which they were dug (Popham et al. 1993, 39), is not convincing.

¹⁴ The excavators expressed uncertainty as to whether lashings or carved joints had been used to join the timbers in the LK-T building (Popham et al. 1993, 48-9). They interpreted the mutual staggering of the centre posts and wall posts as being due to the possible lashing of crossbeams to the centre posts (Popham et al. 1993, 49), but reconstructed the building with a series of crossbeams attached to the centre posts by means of deep, carved joints (Popham et al. 1993, 47, fig. 1, pl. 28).

¹⁵ C. R. Calladine, pers. comm.; M. De Jong, pers. comm.

¹⁶ Therefore, no truss-roof system was used here. This is not surprising, since in timber-framed buildings, this elaborate system is used in connection with posts standing off the ground and necessitates the perfect alignment of opposite posts (for the carrying of the truss) (see Appendix 1: A.2, B.1.IV), which is not the case at LK-T. The truss system appeared much later in the Greek world, where it was used in buildings with masonry walls and 'when the width to be spanned without intermediate supports exceeded 11 meters' (see Ulrich 2007, 138 ff. with further references).

¹⁷ I. Kavrakov, pers. comm.

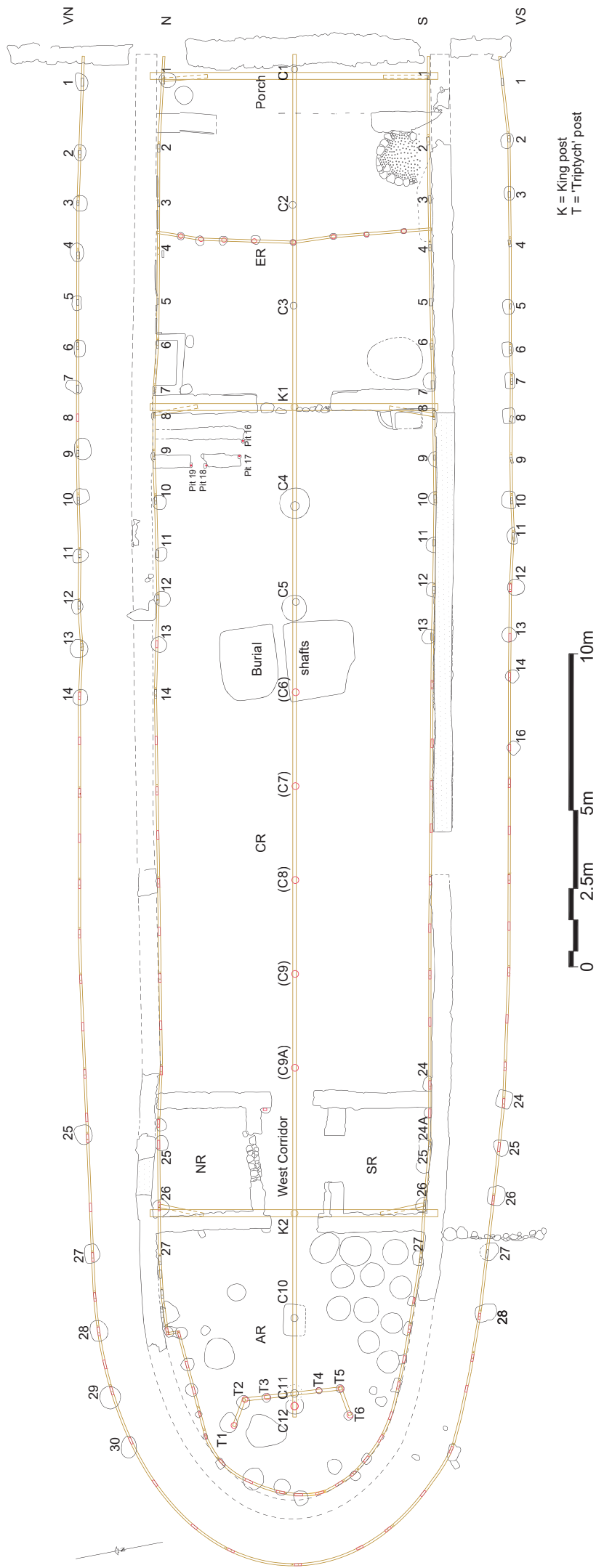


Fig. 4. Reconstructed plan of the ridge beam(s), plates and crossbeams (in brown) superimposed on the existing plan (in black).

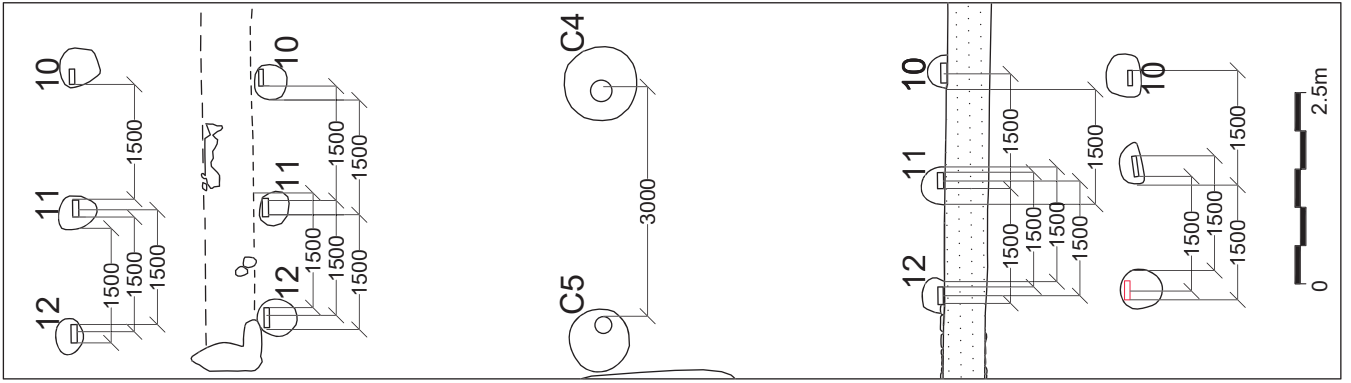
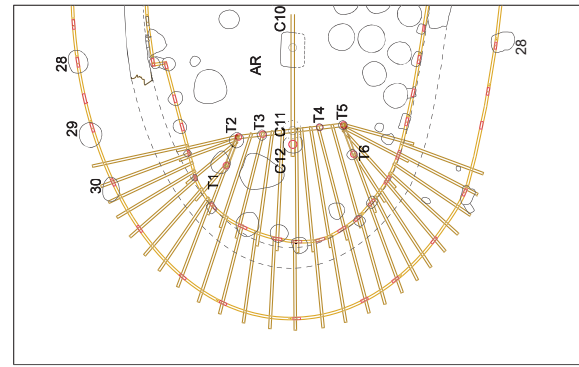
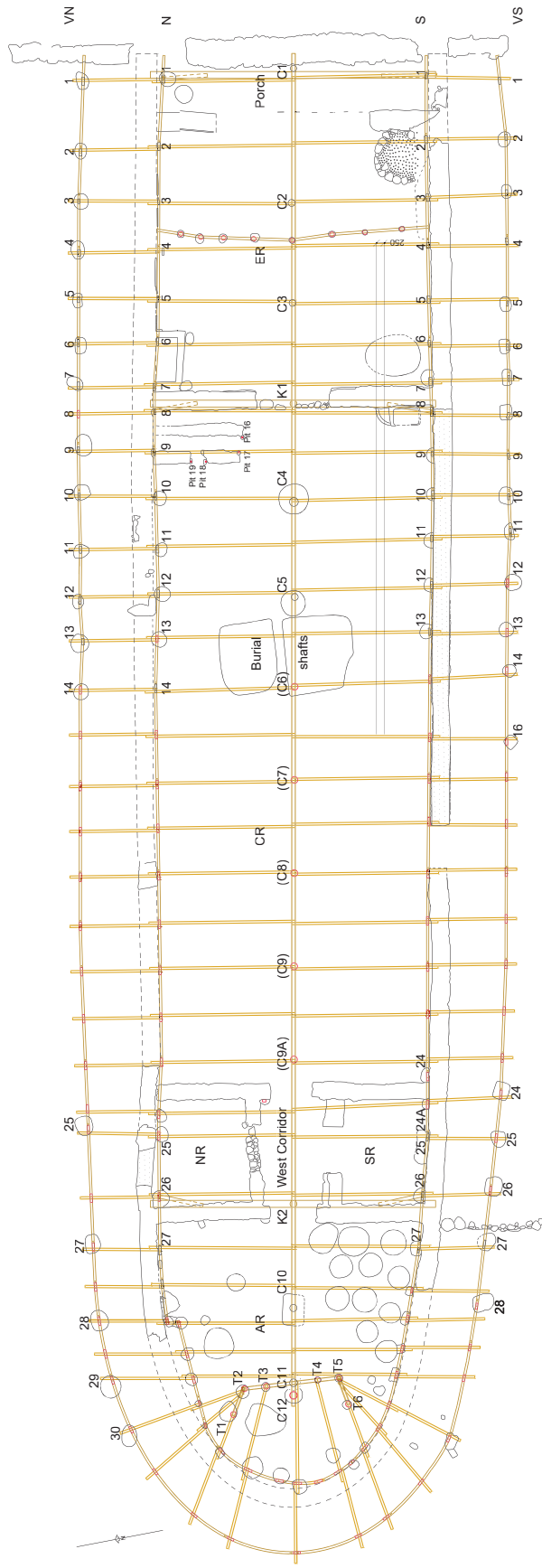
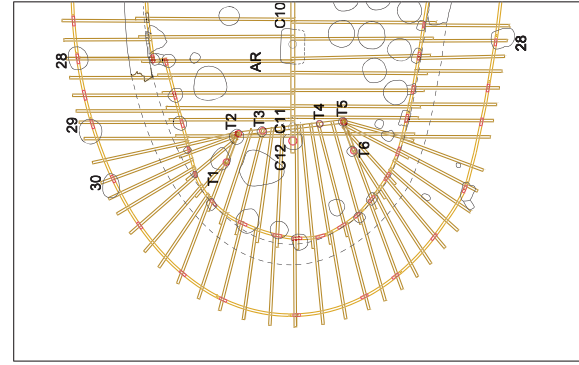


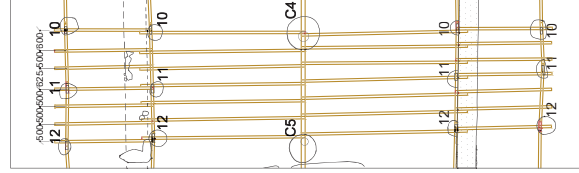
Fig. 5. Typical section across the building with general transverse alignment of all posts.



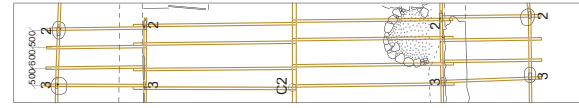
Inset A



Inset B



Inset C



Inset D "

Fig. 6. Reconstructed plan of the roof with principal rafters (in brown) superimposed on the existing plan (in black). Insets A-D: principal and common rafters in three different parts of the building.

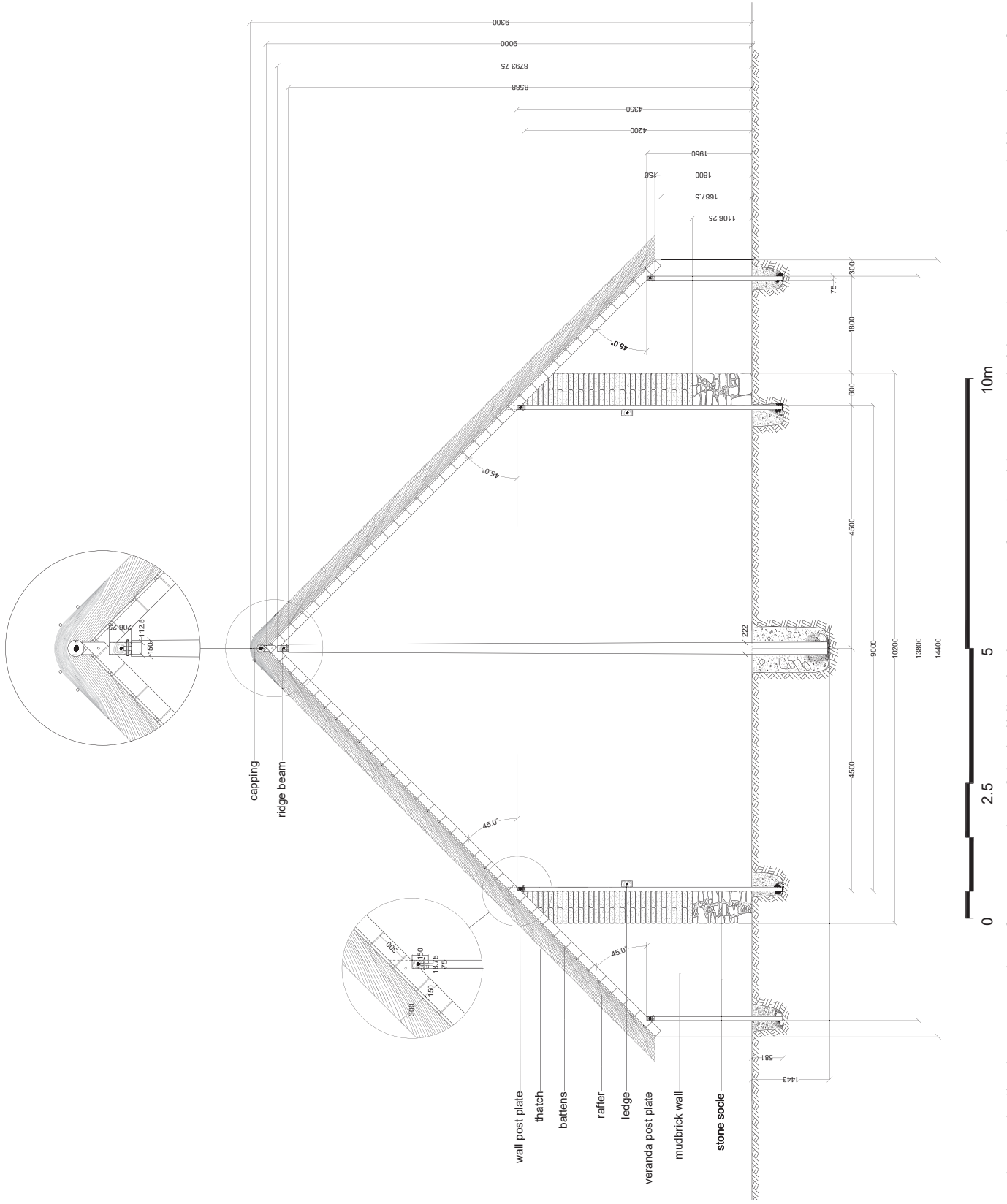


Fig. 7. Idealised reconstruction of a cross-section of the building in the area east of B-B', with 'prop-and-ridgepole' or 'column-and-ridgepole' roof construction. The details of the walls and post pits are hypothetical.

(Figs 4, 8, 9; Appendix 3: III), thereby providing important diagonal bracing to the timber frame.¹⁸ Additional bracing would have been provided by the floor joists and floorboards of the loft above the ER and the Porch (Fig. A3:4b; Appendix 4: II, Fig. A4:3), as well as by a ‘ledge’ attached to the wall posts at mid-height, on which the first landing of the staircase and the roof joists of the cabins in the CR could have rested (Figs 7, 8, 9; Appendix 3: III, Fig. A3:4c; Appendix 4: III, Figs A4:1b, A4:2, A4:4).¹⁹

Having established the use of a combination of centre posts and king posts for the support of the ridge beam(s), we can now reconstruct the intervals between the timber uprights on the long axis of the building as shown in Fig. 10. This figure shows that the division of the building's interior into three main spaces (front-central-rear) separated by partition walls that included doorways, as reconstructed here, played an important role in determining the intervals between the ridge-supporting posts on the long axis of the building (and, by extension, their corresponding intervals between the wall- and veranda posts), as well as the intervals between the last centre post (C12) and the two wall- and veranda posts on the long axis of the building: thus, a symmetry would have been created in the timber frame between its front and rear parts (both equal to 11.156 m) on either side of its central part (equal to 25.987 m) and, within each of these parts, the axial intervals would have been determined according to structural and other needs. The figure also shows that the intervals between the ridge-supporting axial posts would have been measured from edge to edge of post rather than from centre to centre of post.

We are therefore now able to provide some answers to the question of the relative irregularity in the spacing of all the posts. Four main factors appear to have contributed to this: (a) the clear intention to ‘break’ the sequence of centre posts’ intervals in the areas of the partition walls between ER-CR and CR-AR, and treat each room separately in terms of post spacing; b) the placement of wall posts next to the partition walls, either on each side or on one side of them (these are, respectively, posts N7-8, S7-8 and posts N26, S26), probably due to the need to connect the crossbeams supporting king posts K1 and K2 with them; these posts would be considered to begin (or end) a sequence within a room, and the location of their corresponding posts in the veranda would have been determined accordingly; (c) the need for all the posts to be staggered mutually to accommodate pairs of adjacent ‘principal’ rafters; and (d) the actual procedure that was possibly followed during the setting of the wall- and veranda posts: if the site had originally been marked out in some fashion with these intervals (e.g. by using cords marked with a powdered pigment) and the workmen were instructed to dig their post pit and place their post ‘next to the mark’, it is obvious that a variety of relationships between the post pits and the marks could have resulted (Fig. 5).

The rafters and all the other timbers used in the roof (ridge-beams, plates, crossbeams, and king posts) are best reconstructed as squared timbers, with a rectangular cross-section, like the wall- and veranda posts (Fig. 7), rather than as poles. For if time and effort were not spared in squaring the timbers of the wall- and veranda posts, as well as those of the doorjambs, it would be natural to also want to shape the wooden elements of the roof in a similar manner, especially since they too would have been intended to be exposed and visible from the interior of the building (cf. the timber-framed buildings characteristic of 12th-18th century northern- and central Europe – Appendix 1, B.1.IV).²⁰ Indeed, a homogeneous timber-frame structure with a profusion of squared members would have given a more luxurious appearance to this prestigious building, and a feeling of pride to its sponsor and owner (cf. the contribution of the *mesodmai*, which are described as ‘beautiful’ (*καλαί*), alongside the beams (*δοκοί*) of fir and the high columns (*κίονες*) – all of which appear glowing and inhabited by a god – to the marvellous and Olympian appearance of the palace of Odysseus, and the feeling of admiration and pride they aroused in his son, Telemachus – *Odyssey* 19, 35-43). Moreover, squared timbers imply the use of carved joints, which are a stronger type of connection compared to the lashings commonly used in pole-frames (Appendix 1: A.2, B.2.1; see also e.g. Lotay 2015, 36); carved joints transfer the load through the frame and help to tie the whole structure together, thereby making it more rigid against loads (including the wind load and the outward thrust of the roof), in addition to facilitating the joining together and final assembly of the squared timbers of the frame and the roof – a worthwhile reward for the greater labour expended in their production.²¹ This presupposes, of course, that such joints were well executed in the LK-T

¹⁸ No diagonal bracing appears to have existed between the wall posts, judging from the inner face of the south wall in the CR, which was well preserved and reached a height of 1.30 m, with a thick plaster adhering to it (Popham et al. 1993, 14, pl. 31b).

¹⁹ On the various types of bracing, see Appendix 1: A.2.

²⁰ J. Moreira, pers. comm.

²¹ †A. Baggs, pers. comm.; J. Moreira, pers. comm.

building, especially since the timber frame would not have been pre-assembled on the ground (see *infra*, Section II), unlike, for example, the construction of British box-frame buildings (Appendix 1: B.1.IV).

A variety of carved joints would have been used to interlock the squared timbers of the LK-T building with each other (see Appendix 3: IV). Since no iron nails were found in the building (Popham et al. 1993, 48), the joints would have been held in place with wooden pegs or wooden nails (dowels) (such as those used by Odysseus for mortising the timbers of his ship in *Odyssey* 5, 248), having their action supplemented by wooden wedges. Wooden pegs or nails are the natural thing that a carpenter uses to give resistance to a squared-timber frame and prevent movement; they are indeed very strong, capable of forming extremely tight joints, and much more effective than iron nails, which are also likely to corrode quickly (Mercer 1951, 257-60; Hodge 1960, 98; Forrester 1975, 24; Harris 1979, 13; Brown 1986, 38; Brunskill 1994, 37-8; Zwerger 2015, 68, 104, 122-3, 253).

Let us now proceed to the reconstruction of the roof cover. As already mentioned (*supra*, Introduction), patches of reeds or rushes were found on the floor in various parts of the building. This clearly implies that the cover of the roof was thatched, and therefore lightweight, as is the case with many timber-framed buildings (Appendix 1: B.1, B.2). The use of reeds or rushes, more specifically, as thatching material is another indication that this is a high standard building. Indeed, compared to straw, (water) reed is the most durable, finest, and highly prized of all thatching materials. Reed thatch is waterproof and resilient thanks to the water-repellent qualities of the reed, a waxy organic material, and can last 60 to 100 years, while it creates a beautiful thin, close-cropped, and neat roof with sharp edges (unlike straw thatch, which must be renewed after about 15 years, creates a thicker and more rounded roof and gives the impression of having been heaped), and has high thermal insulation properties (West 1971, 112-13; Brown 1986, 110-11; *The Thatcher's Craft* 1-2, 47, 123; Hall 1988, 3-4). Often, (water) reed is mixed with rushes and this mixture (known as 'mixed reed') is preferred for its greater durability, as well as for its tapering and its distinctive appearance (*The Thatcher's Craft*, 123), and this could also have been the case for the LK-T building. A reed thatch coat does not need to be more than 300 mm, a standard thickness, which has also been adopted for the reconstruction of our building (Fig. 7); when laid to 300mm thickness, reed can weigh around 40 kg/m² when dry and up to 50 kg/m² when wet, being the heaviest thatching material (*The Thatcher's Craft*, 214; Hall 1988, 10, 44). The bundles of reeds, c. 1.5-2 m long, would have been stitched (with string or fibre, less likely with wire) to horizontal battens,²² which would have been attached by means of lashings on the 'principal' and 'common' rafters (Fig. 7; Appendix 3: IV) for the purpose of adequately fixing the thatch and providing a closer framework for the safe work of the thatcher (*The Thatcher's Craft*, 214; Hall 1988, 10). The apex of the thatched roof may be reconstructed with a capping of straw or sedge (which, unlike reed, are materials flexible enough to bend without breaking) that would have run the full length of the ridge of the gable roof, being fastened to a roll of reeds placed at the intersection of the rafters to maintain the steep pitch of the last two layers of reeds (*The Thatcher's Craft*, 168, 173-87; Hall 1988, 31) (Fig. 7).²³

As regards the pitch of the gabled roof, a thatched roof must be steeply pitched to ensure maximum water runoff with minimum penetration into the thatch coat and thus avoid the rapid decay of the latter (Hall 1988, 9). Since the pitches of thatched roofs in northern European timber-framed buildings are between 45° and (in areas with heavy snow) 60° and especially those of reed thatched roofs between 45° and about 50°,²⁴ and since the question of the roof pitch is at the same time the question of the respective heights of the different posts supporting the roof and, here, also of the veranda (the latter being restrictive and not favouring very high pitches), one can assume the minimum required pitch of 45° for the reed thatched, gabled roof, with the veranda roof built as an extension of the main roof of the building. In that case, a height for the veranda posts (to the underside of their plates) equal to 1.80 m, gives: a minimum height of roof (to the lowest point of the veranda rafters) equal to 1.69 m, which is reasonable; a total height of 9.30 m for the building (up to the apex

²² For the stitching of thatch with string, fibre or wire, see Hall 1988, 11, 21, 25; the alternatives of screwing and nailing (Hall 1988, 11, 21-3) are excluded here. For the stitching of thatch to battens, see *The Thatcher's Craft*, 132-9; Hall 1988, 10-11, 21, 28-9.

²³ I have opted for the simpler and more common version of capping, such as that of the house models from Samos (Schattner 1990, figs 35, 36, 37, 38, pls 19:3-4, 20:1-3, 21:1-3) or the timber-framed thatched buildings of Northern Europe (see Appendix 1: B.2.1), as opposed to the twisted grass capping illustrated by the house model from Perachora (Schattner 1990, fig. 8). For the roll, cf. also the restoration of a Bronze Age house at Százhalombatta (Hungary) (Jerem et al. 2010, fig. 33).

²⁴ Glendenning 1948, 3-4; *Roofing*, 2-8: 3, table I; Clifton-Taylor 1962, 280-90, especially 284; *The Thatcher's Craft*, 220. Cf. early Greek clay models of thatched houses: two of these models, from Perachora (Schattner 1990, 37-8, fig. 10) and Samos (Schattner 1990, 76-8, fig. 36), show a pitch of 45°; others (Schattner 1990, figs 2.3, 4, 8, 35, 37, 38, 41) show pitches between 50° and 70°.

of its thatched roof); a height of 9.0 m for the timber frame (up to the top of the rafters' crossing on the ridge beam), which is equal to its width (and the internal width of the building);²⁵ the heights of 8.79 m, 8.58 m, 3.67 m, and 4.20 m, respectively, for the ridge beam (to its top), the centre posts, the walls, and the wall posts (to the underside of their plates) (Fig. 7); and a height of 4.275 m from the floor to the underside of the crossbeams, two of which would have supported the floor joists of the loft (*supra*) (Fig. 8); interestingly, 4.275 m is also the height of the second landing of the staircase that would have given access to the loft over the ER and the Porch, according to our reconstruction (Fig. 8; Appendix 4: I, II, Fig. A4:2), thus making likely the reconstruction of the loft at a height of 4.76 m from the floor (see also Appendix 4: II).

The gabled roof, with its pattern of antithetical pairs of adjacent rafters set perpendicularly on the ridge beam, would have continued to the last centre post, C12 (Fig. 6). However, to the west of line Z-Z', its pitches would have been gradually modified due to the progressive narrowing of the building for the formation of the apse, as can be seen in Fig. 9 showing a cross-section in the area around the partition wall between CR-AR, and in Fig. 11 showing a cross-section in the area around C12, where we further observe that, in this zone, the pitch of the main roof would have also been different from that of the veranda roof.

Fig. 11 also depicts, in the centre, part of the different roofing arrangement that had to be adopted to cover the west half of the AR and the surrounding veranda. In this area, beyond C12, a hipped roof would have been used (Fig. 12),²⁶ with a pitch of 47.2° and with the veranda roof built as an extension of the roof over the west half of the AR. The hipped roof would have been supported by a special, 'tritych'-like structure made of the centrally located (but not ridge-supporting) post C11 and of posts T1-T3 and T4-T7 forming two almost symmetrical, L-shaped arrangements on either side of C11 (Fig. 6: Inset A);²⁷ all these posts would have been crowned by plates, a horizontal plate over posts T2, T3, C11, T4 and T5 (see also Fig. 11) and two cranked plates respectively over posts T1-T2 and T5-T6, and perhaps also another horizontal plate over posts T1 and T6 for the bracing of the 'tritych'²⁸ (not shown on Fig. 6). On the plates of the 'tritych' would have rested, in a fan-shaped arrangement, the upper ends of the interior rafters of the hipped roof, their lower ends resting on the plates above the wall posts; the latter would also have received the rafters of the veranda roof (Fig. 6: Inset A and Fig. 12). The plates for the wall- and veranda posts in the apsidal part of the building would probably be curved (rather than straight) timbers.^{29 30} Adopting a hipped roof over the (west end of the) apse would have been yet another method – besides embedding the posts and adding verandas acting as aisles (*supra*) – used by the LK-T carpenters to ensure the structural balance of the building, since this type of roof offers the advantage of resisting high winds (see Appendix 1: A.2, Fig. A1:6ab; Appendix 5: II.b and Discussion).

The east facade of the building would have had a gable, as clearly suggested by the axial post in the middle of this short side (Audouze and Büchschütz 1992, 59). The presence of a loft above the ER and the Porch (Appendix 4: II) would have required the gabled end to be closed (with materials such as planks or thatch), perhaps with a door-like opening, such as that shown, for instance, by the terracotta house model from the Heraion at Argos (Appendix 1: B.2.2.3, Fig. A1:21). Under the gable, the entrance to the building would

²⁵ Cf. the longhouses of the Iroquois and Huron (North America), which were as high as they were wide (Coucouzeli 1994, 320-21).

²⁶ For hipped roofs, see Fig. A1:6a; Brunskill 1992, 93, figs 34e, 60a, 125; for a combination of gabled and hipped roof, as in LK-T, compare also the ancient Greek house models from Ithaca, Perachora and Samos (Schattner 1990, 28-31, fig. 4; 33-5, fig. 6, pl. 4; 74-6, figs 34, 35, pl. 19: 3-4; 76-8, fig. 36, pl. 20:2-3).

²⁷ *Contra* Popham et al. 1993, 50, where this alignment of posts is identified as a light partition wall (Popham et al. 1993, 50). The 'tritych' posts T1-T6 are associated with Pits 20, 20A, 24, 26, 31 and 32 (Popham et al. 1993, pl. 23), which according to the excavators 'may have held the posts of a light partition' (Popham et al. 1993, 44, 50). With the identification of a 'tritych' structure in the apse, C11 can no longer be considered as the last (ridge-supporting) centre post (as assumed by the excavators) and this role is now taken up by another post, C12, which would have been embedded in Pit 25; the latter contained traces of ashes (Popham et al. 1993, 25, table 4, pl. 23), which were presumably remains of wood.

²⁸ J. Moreira, pers. comm.

²⁹ J. Moreira, pers. comm.

³⁰ The shallow depths of the pits of the 'tritych' posts and those of the wall- and veranda posts in this area, i.e. 0.23 to 0.30 m compared to the usual 0.50 m in the rest of the building (Popham et al. 1993, 25, table 2), if not due to the artificial terracing of the lower ground in this part of the site or to damage caused by bad weather or bulldozing (Popham et al. 1993, 36) or simply to the fact that the post pits were still being dug, may be another clue to the existence of a hipped roof in this area – cf. the Danubian LBK Neolithic longhouses, about which it has been argued that the weaker anchorage of the posts at one end could be linked to the fact that they would have been subjected to a weaker vertical thrust due to a hipped roof (Appendix 1: B.2.1).

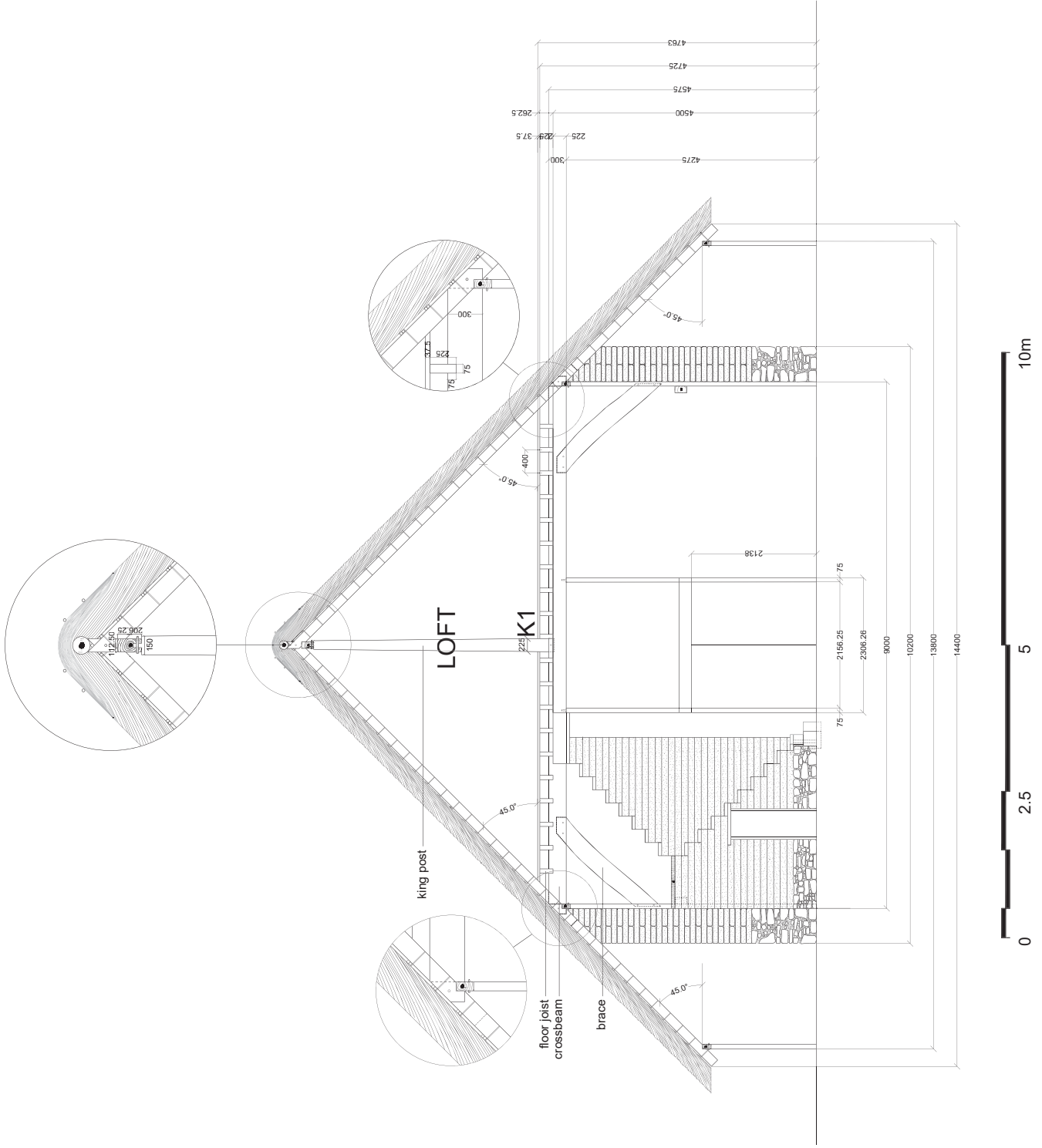


Fig. 8. Idealised reconstruction of cross-section A-A', with 'prop-and-lintel' or 'post-and-beam' roof construction. The details of the walls are hypothetical. The post pits have been omitted.

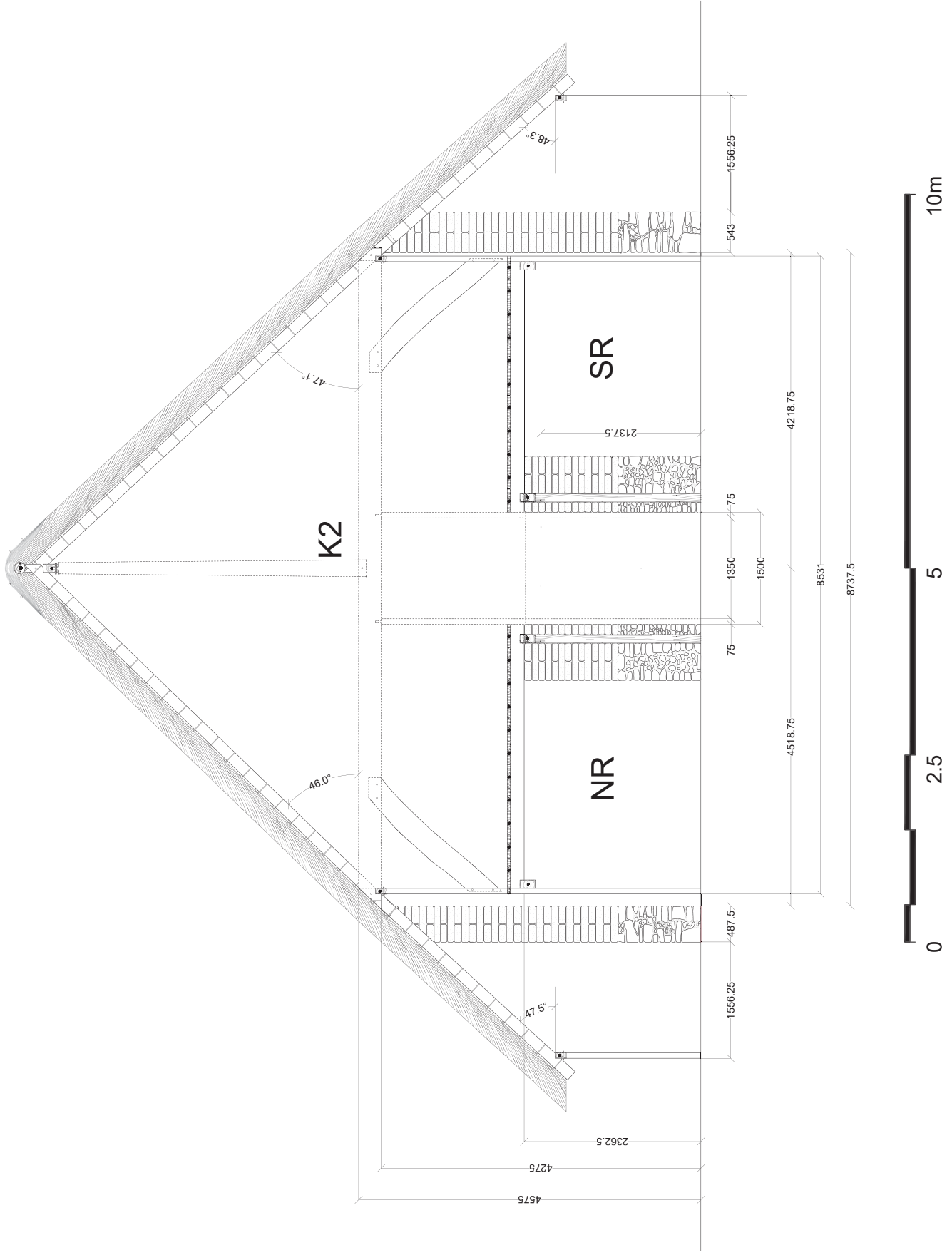


Fig. 9. Reconstruction of cross-section C-C', with 'prop-and-lintel' or 'post-and-beam' roof construction and including the North Room (NR) and South Room (SR). The details of the walls are hypotheticalal. The post pits have been omitted.

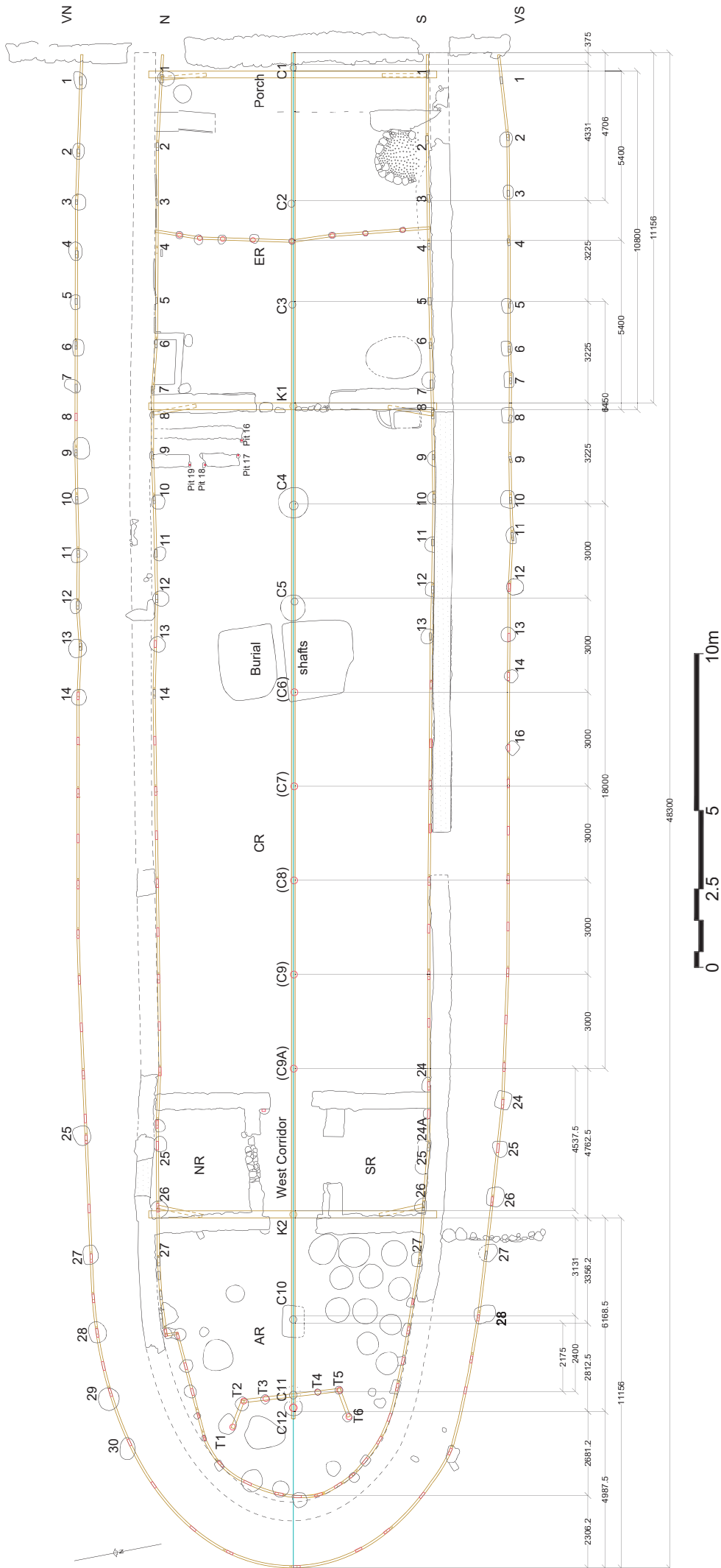


Fig. 10. Reconstruction of the intervals between the timber uprights on the long axis of the building.

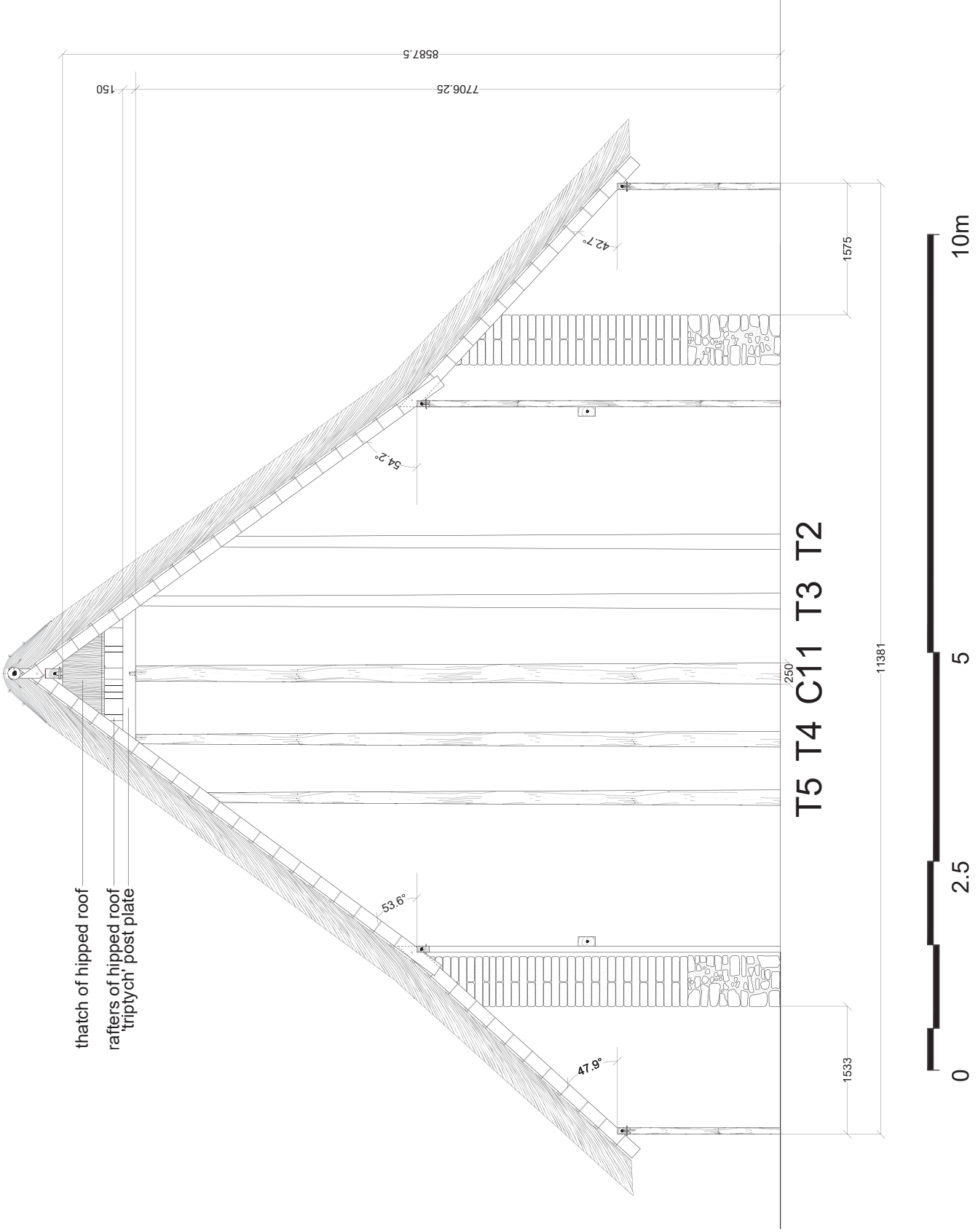


Fig. 11. Reconstruction of cross-section D-D', showing the main part (T2-T3-C11-T4-T5) of the 'triptych' structure supporting the hipped roof over the west end of the apse. The details of the walls are hypothetical. The post pits have been omitted.

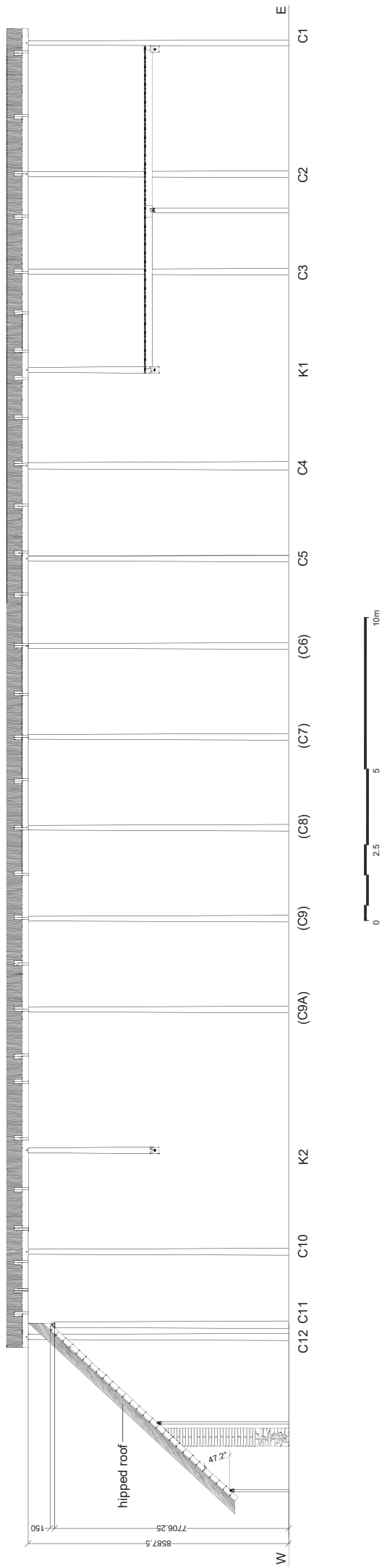


Fig. 12. Idealised reconstruction of a cross-section along the building, south of its longitudinal axis. The post pits have been omitted.

have been monumental (reconstructed width: 5.175 m³¹ – see Fig. 3) and framed by a substantial wooden lintel and doorjambs presumably made of squared timbers, like those which left their traces in the rest of the building.

We shall now examine how the timber frame and the roof that it supported might have been produced.

II. THE PRODUCTION OF THE TIMBER FRAME AND ROOF

by Alexandra Coucouzeli

The production of the timber frame and roof of the LK-T building must have involved carpenters of a high standard. Like in the case of the timber-framed buildings in medieval northern Europe, the LK-T carpenters would have been the master builders on the site; indeed, the ancient Greek word for ‘carpenter’, *τέκτων*, is closely related to the idea of woodworking and building (Singer et al. 1956, 233; Liddell and Scott 1996, s.v. *τέκτων*; Kakaras 2013, 118-9; cf. the Japanese *daiku* – Zwerger 2015, 58). This connection is already found in Homer, where the carpenters, *τέκτονες*, are at the same time furniture makers (*Odyssey* 19.56), builders of boats (*Iliad* 5.59; 13.390; 15.411; *Odyssey* 5.250; 9.126) and builders of houses (*Iliad* 6.313-316, referring to the palace of Paris in Troy, built by the best carpenters; *Odyssey* 17.384 and *Odyssey* 21.43, referring to the carpenter as a builder using wood, *τέκτονα δούρων*,³² and as a builder of the threshold, door jambs and doors of a doorway, respectively).

The LK-T carpenters or *τέκτονες* would have had crucial decisions to make pertaining to: the different depths required for the embedment of the centre posts, on the one hand, and the posts along the walls and the veranda, on the other; the shape, dimensions and proportions of the timber frame members and the joints that interlocked them to each other; the orientation of the wall- and veranda posts; and the height and pitch of the roof, to ensure the overall structural equilibrium and strength of the timber frame to resist the action of the roof load,³³ the wind forces, but also the earthquakes, to which Euboea was particularly prone (see Appendix 5: III).

The use of ‘squared’ timbers for the majority of the posts (i.e. the wall- and veranda posts) of the LK-T building, probably also for other elements of the frame and for the entire roof as reasonably reconstructed above, implies a laborious process of conversion of tree trunks and fairly advanced carpentry skills (Appendix 1: A.2), as well as a technological level such as to include the manufacture of rather complex tools or equipment suitable for working the wood with precision. Indeed, unlike pole-frame buildings, which exploit the natural qualities of trees with minimal conversion and only require tied connections between poles, without the use (or with minimal use) of tools, a squared timber frame building like the one at LK-T would normally have required, as already mentioned, carved joints for the interlocking of the timbers; these joints would of course have been made before they were put in place and should have been carefully shaped and tight-fitting, if they were to produce a rigid and long-lasting frame, since in square timber framing ‘the critical thing is to get the joints right’.³⁴ Special tools and jointing techniques, and by extension skilful carpenters, were essential to this effect. Given, however, the irregularities in the dimensions and spacing of the posts, one does not expect at LK-T the very high level of ‘prefabrication’ and precision exhibited, for instance, by the traditional box-frame buildings in Britain, whose various frames were pre-assembled on the ground (Appendix 1: B.1.IV).³⁵

³¹ Popham et al. 1993, 43: ‘nearly 5 m wide’. Cf. the 5.50 m wide entrance of the Hekatompedon II on Samos (Appendix 1: B.2.2.3); the 4.92 m wide, monumental door of the Parthenon (Meiggs 1982, 198); the 3.66 m wide, two-leaved doorway of the megaron in the Mycenaean palace at Pylos (Meiggs 1982, 103); the 3.50 m wide doorway of the ‘Daphnephoreion’ at Eretria (Appendix 1: B.2.2.3); and the wide entrance of the house model from the Heraion at Argos (Appendix 1: B.2.2.3, Fig. A1:21).

³² *δούρων*: gen. pl. of *δόνυ*, stem, tree, plank or beam (Liddell and Scott 1996, s.v. *δόνυ*). In *Iliad* 12.36, the *δούρατα πύργων* are the beams of the towers in Troy, while in *Iliad* 24.448-51, the *δοῦρα* are clearly the posts in Achilles’ thatched hut, rather than the beams of the roof, since the latter is described thereafter.

³³ The imposed load of the roof exposed the earthfast posts to deflection but also to the danger of sinking into the ground (Zwerger 2015, 62, 79, 105).

³⁴ On the different jointing requirements of pole-framed and timber-framed constructions, see Zwerger 2015, 112, 116-20. On the requirement of carefully shaped and fitted joints for a solid and long-lasting timber-framed structure, see Brunskill 1994, 36-7; Oliver 1997, 281; Zwerger 2015, 61-2, 79.

³⁵ Cf. Hansen 1971, 69, who argues that the irregular spacing and relative positioning of posts set in pits (rather than upon footings of stone) in early timber-frame buildings in Britain precludes prefabrication and very precise jointing together of the timbers, unlike, for instance, in later box-framed buildings (Appendix 1: B.1.IV).

For a carpenter to acquire knowledge of his craft and accumulate empirical experience in producing a solid and lasting timber frame by means of precisely executed and tight-fitting carved joints, one to two generations are needed (Zwenger 2015, 61, 65, 105). One therefore expects that by the time of the construction of the LK-T building, c.950 BCE, the knowledge and skills of building carpentry had been handed down and accumulated over a few decades, undergoing constant refinement, adaptation and experimentation, though presumably with smaller-scale timber-frame structures, with the parallel development of iron technology, which would have permitted the production of accurate tools of steel-like quality and the creation of ever more precise wood joints.³⁶

The realization of the proposed timber frame and roof for the LK-T building would have involved the following stages, typical of traditional timber frame construction (Mercer 1951, *passim*; Oliver 1997, 286-7), each one of which characterised by the use of specific tools.³⁷

1. Preparation. First, the trees, most likely conifers with cypress being the best candidate (see Appendix 2: I), would have been felled and made into logs by sawing off their branches using a felling axe (cf. οἱ δ' ἴσαν ὑλοτόμους πελέκεας ἐν χερσὶν ἔχοντες/And they went forth bearing in their hands axes for the cutting of wood – Homer, *Iliad* 23, 114; cf. the πέλεκυς used by Odysseus when felling trees for the construction his 'raft' or ship – Homer, *Odyssey* 5, 234-244); the felling would have taken place in spring for the 'round' logs (used for the centre posts) whose bark had to be stripped, but in autumn and winter for the 'squared' timbers (used for the remaining framing and roof members) (see Appendix 2: I). Once transported to the site, the logs would have been converted into round timbers by being debarked using a felling axe and into square timbers by being cut to the required lengths using saws.

For the conversion of the logs to squared timbers, the logs would have been marked with lines along their length using a cord covered in powdered pigment, such as chalk or ruddle (red ochre) (Singer et al. 1956, fig. 352; Bayford 2001, 13), and then sawn through and through along the marked lines, following the method of 'plain sawing'. In this method, the log is 'slabbed', i.e. cut out into 'slabs' or 'deals'. The various dimensions or 'scantlings' (i.e. widths and thicknesses) of the rectangular wall- and veranda posts (*supra* and Table A3:1) would have been produced by slabbing logs from average-sized trees (c.27.5-37.0 cm in diameter), a single log being able to produce either four 'deals' (of which two pairs with the same scantlings) or three 'deals' (of which one pair with the same scantlings) (Fig. 13). 'Plain sawing' is the fastest and easiest method of cutting timber, but also an essential method for the economic conversion of tree trunks, since one trunk can produce a number of sizeable timbers of a rectangular cross-section with the least amount of waste,³⁸ however, the outer 'slabs' (the 'slabs' near the top or bottom of the end surface or 'end grain') of plainsawn logs are prone to warping (cupping) and only the centre slabs (the 'slabs' from the middle of the log's end grain) 'will remain perfectly flat' or will show minimal distortion.³⁹ Since the vast majority of the (surviving) squared posts at LK-T appear to have been straight (at least in their parts within the post pits) and have dimensions such as to

³⁶ Snodgrass 1971, 228 ff. On the role of iron technology in the continuous development of new tools and the creation of increasingly refined and specialized wood joints, such as all the joints known to us today from square-timber framed buildings, see Acland 1972, 12-14; Zwenger 2015, 122, 128.

³⁷ For the various tools cited below, all of which are documented in the ancient Mediterranean and some of which (such as saws, axes, adzes, and chisels) are already attested in Greece by the tenth century BCE, see: Flinders Petrie 1917, 5-22, 39-40, 42; Mercer 1951, *passim*; Blegen 1952, 289 nos. 6-7; Singer et al. 1954, 189-90, 481, 618-20, 687-9; 1956, 228-31, 243, 389-92; Brock 1957, 137-8, 202; Orlandos 1959-60, 131-44; 1966, 29-45; Deshayes 1960, 46-50, 79-80, 98-100, 105-9, 361-2, 394-5; Pleiner 1969, 15; Snodgrass 1971, 233, 249-50; Hansen 1971, 186; Harris 1980, 5; West 1971, 20; Forrester 1975, 25-7; Harris 1979, 17, 19; Gaitzsch 1980, *passim*; Meiggs 1982, 346-9; Brown 1986, 31-3; Brunskill 1994, 30-3; Oliver 1997, 255-7, 281, 286-7; Hijmans 2003, 126-7; Ulrich 2007, 16-57; Kostoglou 2008, 44-7; Kakaras 2013, 119-29; Zwenger 2015, 26, 53, 68, 71, 120-2, 125, 127; Blackwell 2020 with further references. For evidence of EIA tools at the site of Toumba at Lefkandi, see Popham et al. 1993, 31 n. 1 (marks of adze from the LK-T burial) and Popham et al. 1979, 256; Popham and Lemos 1996, 201 (axes/adzes from the Toumba cemetery).

³⁸ As opposed to 'quarter sawing' or 'rift sawing', which, even though they produce more stable timber, are more time-consuming, generate a higher amount of waste, and are used for specific purposes (furniture making, string instruments, etc.). See Singer et al. 1956, 389-90, 392; Fletcher and Spokes 1964, 177; Forrester 1975: 69; Harris 1979, 17; Oliver 1997, 255-6; Zwenger 2015, 128; Bayford 2001, 14; Ulrich 2007, 236, fig. 11.16; *Wood Handbook*, 3-14.

³⁹ Bayford 2001, 14; *Wood Handbook*, 4-5, fig. 4-3. This is because in the outer 'slabs' the growth rings, as seen on the log's end surface or 'end grain', lay tangentially to the width of the timber, whereas in the central 'slabs' the growth rings lay more and more perpendicularly to the width of the timber in a radial (i.e. pith-to-bark or centre-to-edge) direction; in the former case, the rings will expand or contract more, since wood shrinks (swells) most in the direction of the annual growth rings, i.e. tangentially, and about half as much across the rings, i.e. radially (*Wood Handbook*, 4-5, fig. 4-3), causing a significant amount of warping (cupping). In general, wood cut from the heart of the tree is more stable against warping.

suggest that they come from the central part of the logs shown on Fig. 13, compared to a small minority (of eight) that would have come from the outer, curved parts of the logs, it is reasonable to assume that the carpenters were well aware of this fact. The refined method of plain sawing would also have been used for the boards forming the treads of the staircase and the floors of the loft and the mezzanine (cf. Ulrich 2007, 236, fig. 11.16). The LK-T carpenters would therefore have benefited from (or ushered in?) a major advance in construction technology by converting whole logs into squared timbers based on the principle of ‘slabbing’, thus skilfully optimising the potential of the wood as building material. The sawing would have been done by two sawyers using a ‘cross-cut saw’ (or ‘two-handed saw’)⁴⁰ or a large ‘frame saw’ operated over a saw-pit (Singer et al. 1956, fig. 357; Meiggs 1982, fig. 14d) with one man pushing and the other pulling, in an up-and-down movement.

The sawn ‘slabs’ would have been squared at their ends using a square and an axe or adze, then ‘dressed’ (trimmed) using a broad axe, and subsequently smoothed and given a clean finish using an adze (cf. the first stage of the construction by Odysseus of his ship: *πελέκκησεν δ’ ἄρα χαλκῶ, ξέσσε δ’ ἐπισταμένως καὶ ἐπὶ στάθμην ἴθυνεν/[he] trimmed them with the axe; then he cunningly smoothed them all and made them straight to the line*, Homer, *Odyssey* 5, 244-5; cf. *πέλεκυν μέγαν ἢ ἐσκέπαρνον/a great axe or an adze*, Homer, *Odyssey* 9, 391).

After the conversion of the logs to round and squared timbers, all timbers should, in principle, have been neatly stacked on a raised, well-drained surface in the open and allowed to air-dry in order to evaporate as much of their moisture content as possible (seasoning)⁴¹ during the cold winter months,⁴² so that at the onset of the dry season the wood would have been at its strongest (Oliver 1997, 903).

2. Setting out. This stage would have involved preparing the timbers for assembly by setting out the appropriate lengths and joints for them whilst they lay on the ground, including perhaps the numbering of both timbers and joints. The equipment needed for this would have been a series of measuring tools: a scribing tool, a ruler (a one-foot ruler marked with subdivisions in palms and fingers), a plumb line, a level (such as an A-frame level, with plumb bob), various types of squares (for angles), calipers or ‘dividers’, and a pair of compasses.

3. Joint-carving. The joints for interlocking the timbers would have been carved using mainly a chisel, in combination with a wooden mallet, and occasionally also a very small bow-saw. For the necessary holes through the joints to accommodate the wooden pegs or wooden nails, boring bits or augers would have been used (cf. the *τέρετρα* that Odysseus used for his ship and with which *he bored all the pieces [of timber] and fitted them to one another, and with pegs and morticings (γόμοφοισιν ... καὶ ἄρμονίησιν) did he hammer it together* – Homer, *Odyssey*, 5, 246-8) or perhaps even a more complex type of tool, a drill activated by a bow (‘bow drill’) or a more powerful version of the latter, for boring deep holes in heavy timbers, activated by a strap (‘strap drill’) (cf. the *τρούπανον* ‘spinning with the thong (ἰμάντι)’ mentioned in Homer, *Odyssey* 9, 385-6).

After the cutting of the timbers into the required shapes and boring the holes for the carved joints, all the timbers, especially the posts intended to be embedded in the ground, would have had to be treated with a

⁴⁰ For the use of the crosscut saw to produce planks, see Hodge 1960, 96.

⁴¹ Air-drying (seasoning) is essential to prevent decay and stain, as well as swelling and shrinking and, by extension, warping, splitting and checking (i.e. lengthwise separation) of the wood and thus increase its strength properties (*Wood Handbook*, 13–5, 13–6, 14–6, 15–16, 17–7). Ideally, timbers should be dried to the equilibrium moisture content (EMC) that the material will reach when in service, i.e. the moisture content at which the wood is neither gaining nor losing moisture and is therefore dimensionally stable. (Wood is dimensionally stable when its moisture content is greater than its fibre saturation point, MC_{fs} . Below MC_{fs} , wood changes dimension as it gains moisture (swells), i.e. absorbs water from the surrounding air in response to a rise in humidity until reaching EMC or loses moisture (shrinks) in response to dry air until reaching EMC; this shrinking and swelling can result in dimensional changes.) This ideal is possible with pieces of wood less than 0.076 m thick – and it is interesting to note that the average thickness of the wall- and veranda posts in the LK-T building is 0.072 m – but, in general, it is rarely practical to obtain fully dried timbers (*Wood Handbook*, 4–2, 4–3, 4–5, 10–15, 13–3, 16–7).

⁴² This is because during the cold winter months, the cooler temperatures and low air humidity allow for a very slow drying rate, thereby minimising the infestation by insects and the development of fungal growth, mould, and stains, and helping to avoid dimensional changes, as opposed to humid and warm periods with little air movement, which can cause volume increases (swelling) and promote the growth of fungi and colour stains, and periods of dry and hot winds, which can cause volume losses (shrinking), splitting and checking, thereby degrading the quality of the wood (*Wood Handbook*, 13–6).

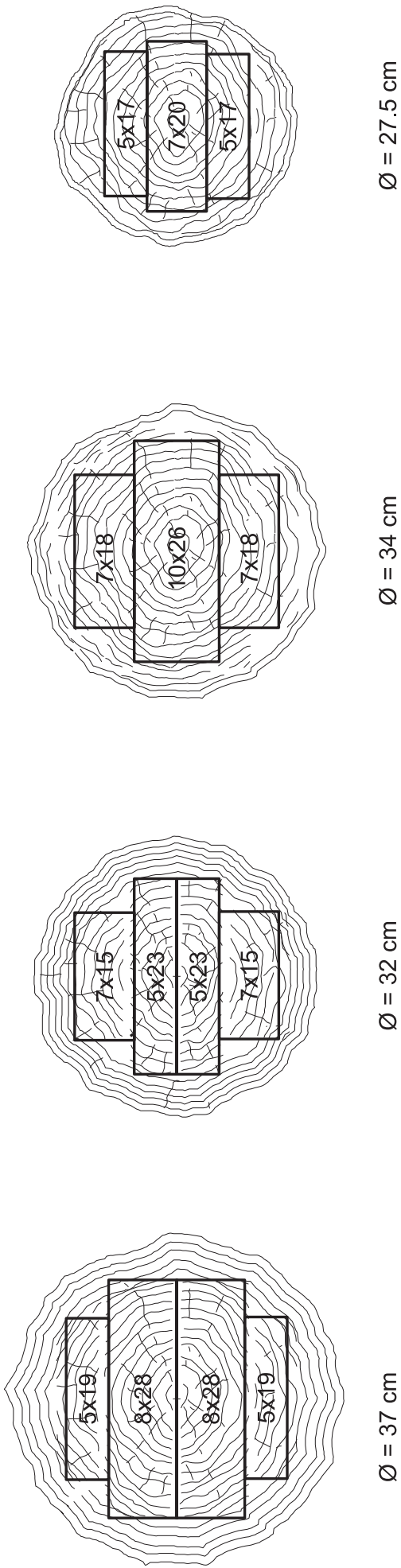


Fig. 13. Deriving the scantlings of the wall- and veranda posts through the conversion of logs into squared timbers by 'slabbing'.

preservative,^{43 44} to prevent them from being attacked by xylophagous (i.e. wood-eating) insects and to delay the process of fungal decay (i.e. rot) over time,⁴⁵ and then left to thoroughly dry.

4. Assembly. For the assembly of the timber frame, in addition to ropes, special scaffolding or forked timbers,⁴⁶ levers or crowbars may have been used, in combination with a plumb line, a level, and various squares for the accurate positioning of the timbers against each other; the last three tools would also have been used to position the roof timbers. Wooden mallets would have been used to secure the wooden pegs, nails and wedges when assembling the carved joints.

5. Roof pitch and cover. The proposed 45° pitch for the roof could have been calculated using a square equipped with such an angle.⁴⁷ The covering of the roof with thatch would have completed the whole procedure; the laying of reed thatch would have involved tools such as wooden leggetts and mallets, hammers, reeding-needles, hooks and various cutting tools (*The Thatcher's Craft*, 205-9).

III. IMPLICATIONS FOR THE STATE OF COMPLETION OF THE BUILDING

by Alexandra Coucouzeli

The identification of the LK-T building as a timber-framed structure and the theoretical precedence of the timber frame over the walls for the carrying of the roof during the construction process imply that it is no longer necessary to assume, as the excavators did, that, at the time of the decision to abandon the site, 'the basic construction including the roofing had been completed', with the walls already built to their full height and all posts and the whole roof installed, only to be intentionally dismantled, to a lesser or greater extent, including part of their stone socles at the east and west ends of the building, so as to leave a low and regular mound or tumulus over the entire site (*supra*, Introduction). This is especially true since no large quantities of stone or mudbricks such as those preserved on the stone socle of the walls were found anywhere on the site, either in the building and its fill or in the ramps (Popham et al. 1993, 6, 13, 23, 30) – although it is possible that a different type of mudbrick was used in the upper part of the mudbrick superstructure of the walls (see *infra*) – and the mound does not appear to have had a regular shape.⁴⁸

The possibility therefore arises that the differences in the preserved heights of the walls, when not due to stone-robbing or mechanical damage, reflect the state of completion (or incompleteness) of the walls. The construction of the walls could have reached different stages in different parts of the building, with their mudbrick superstructure still largely unfinished, whether its upper part was intended to be made of the same type of gritty, brown mudbricks as those preserved on the walls – in which case the remaining mudbricks would still have to be brought to the site – or of the smooth mudbricks of various colours, which formed the

⁴³ *Wood Handbook*, 15–18, advising that 'All cutting and boring of holes should be done prior to preservative treatment'.

⁴⁴ Pitch, which came from conifers, primarily from pines (Theophrastus, *HP* 9.2.5; Pliny, *NH* 16.16-19; Meiggs 1982, 468-70; Kakaras 2013, 118), was an important wood preservative used in ancient times on roof timbers, doors, and timbers exposed to the weather (Meiggs 1982, 439-40, 453, 463, 467-8). Other wood preservatives used in antiquity were cedar oil and *amurca*, the sediment of olive oil, the former more difficult to obtain, being an exotic product, the latter easily available, but mentioned by Cato (*De Re Rustica* 98.2) only in connection with furniture (Ulrich 2007, 261).

⁴⁵ H. B. Voulgarides, pers. comm. The embedded posts, if not treated with a preservative, would have absorbed water, even if well-seasoned (Ulrich 2007, 261).

⁴⁶ Cf. the ways of erecting posts or positioning beams in Papua New Guinea (Coudart 1998, fig. 47).

⁴⁷ One such square survives from Roman times (Ulrich 2007, fig. 3.47).

⁴⁸ Although at its east end, the mound may have ended in a curve, judging by the arched arrangement of the tombs in front of the building, belonging to the Toumba cemetery (Popham et al. 1982, fig. 2; 1993, 9, 55) – its shape at the west end is unknown due to modern damage (Popham et al. 1993, 55) – in a north-south direction, the mound was higher on the building's north side (judging by the surviving portion of the exterior wall in Trial A and the height of its adjoining ramp; maximum preserved height: c. 1.60 m) than on the south side (maximum preserved height: 1.30 m) (Touchais 1982, figs 110, 111; Popham et al. 1993, 6, 13, 53, pls 4, 6, 37). Moreover, on the south side, the exterior wall was higher to the east of the so-called 'secondary doorway' (*supra*, Introduction) than to the west of it (Popham et al. 1993, 13, pl. 4a) and the same is expected for the corresponding parts of its adjoining ramp. Cf. the tumulus covering the EH II apsidal building and the mass burial it contained in the plot adjacent to the Archaeological Museum of Thebes, and which does not appear to have been designed to have a regular shape – the fill of disintegrated, collapsed mudbricks from the building's walls that formed part of this mound has maximum heights of 1.33 m, 1.42 m and 1.75 m, respectively, at the west end (apse), at the central part and at the east end of the building – but rather to simply 'seal' the site (Aravantinos 1997, 358; 1998, 326; Aravantinos and Psaraki 2012, figs 2, 3).

main body of the ramps and which would have initially been intended to create decorative patterns on the walls (cf. Popham et al. 1993, 30, 55, 98).⁴⁹

Thus, it is possible that in the CR: the partition wall between CR-ER had its stone socle still under construction;⁵⁰ the part of the south wall to the west of the so-called ‘secondary doorway’ (*supra*, Introduction) had its stone socle already built but not yet its mudbrick superstructure; other walls (i.e. the north wall, the part of the south wall to the east of the ‘secondary doorway’, and the north wall of the SR) had already received a mudbrick capping of 2-4 courses, up to a height of *c.* 1.30-*c.* 1.60 m; the superstructure of the staircase and its wooden treads had not yet been built⁵¹ (see also Appendix 4: I); and more transverse walls were to be constructed within the CR, which would also have provided the indispensable bracing to the long exterior walls of this room (*supra*, Introduction) – if these walls were in the form of a double series of SRs (as reconstructed in Fig. 3), then (a) the ‘secondary doorway’ in the south wall of the CR would be located almost exactly in the middle of the south series and could therefore be a temporary opening serving a practical purpose during construction work (such as providing natural light to this very large hall apparently already covered with a roof and/or facilitating the circulation and transport of materials inside it⁵²) and (b) a possible mezzanine above the double row of SRs (see Introduction), forming part of the framework, had yet to be built.

At the west end of the building, it is possible that at least the south section of the wall in the AR had not reached any great height, since the south ramp appears to stop short of the apse, at a row of stones which aligns with the east wall of the AR and which may therefore have been intended to mark its western end (Popham et al. 1993, 54). In this region, it is even possible that the timber frame and the roof were under construction: the absence of imprints or remains of wood in the pits relating to the wall- and veranda posts (except for N27, S27, VS27 and VS28) as well as to the posts of the ‘trptych’-like structure, which is unlikely to be due to modern damage (Popham et al. 1993, 34), together with the absence of any thatch remains in the AR (Popham et al. 1993, 97), may in fact indicate an unfinished state of construction. Likewise, the absence of impressions or wood remains relating to the posts across the middle of the ER could indicate that the partition wall here and, by extension, the loft it would support above the ER and the Porch (*supra* and Appendix 4: II) had not yet been constructed.

IV. THE STRUCTURAL INTEGRITY OF THE TIMBER FRAME

by Igor Kavrov, Allan McRobie and Alexandra Coucouzeli

We conducted a forensic engineering analysis (see Appendix 5) to assess the structural integrity of the timber frame of the LK-T building, as reconstructed above and as shown in the idealised cross-section in Fig. 7. Timber frames are lightweight structures; thus, our primary hypothesis in the analysis is that wind poses the greatest threat to structural stability. However, other potential damage mechanisms are also considered, including those related to earthquake and gravity buckling of the centre posts. The natural hazards are

⁴⁹ In favour of the latter hypothesis could also be the fact that there were piles of mudbricks in the ramps (Popham et al. 1993, 29, pl. 37), as if they had been stacked there in anticipation of being placed in the walls. In terms of volume, the mudbricks used in the ramps appear to have largely sufficed for the upper part of the superstructure of the walls, both those that survive and those reconstructed in the present study.

⁵⁰ It is unlikely that the partition wall between CR-ER had been dismantled, because it is for the most part lower in height (*c.* 0.48 to 0.82 m, with only three to four courses of stone on either side of its central doorway) compared to the immediately adjacent sections of the north and south walls of the building (the former, judging by the height of the north ramp, which was built against it) (Popham et al. 1993, 10, pls 6*b*, 9, 11*ab*; see also Touchais 1982, figs 110, 111) – why would this particular wall have been dismantled to a lower height than its adjacent north and south walls? It is also unlikely that the partition wall between CR-ER was robbed in modern times (*contra* Popham et al. 1993, 34, where it is nevertheless admitted that such a hypothesis presents difficulties); no evidence of stone-robbing activity was found in connection with it, unlike the north wall of the building (Popham et al. 1993, 37, pl. 37: East Section) nor is it shown as robbed in Popham et al. 1993, pl. 5. In fact, the north wing of this wall is preserved at the same, very low height as that of the walls that form the stone socle of the nearby staircase, because it would have supported the wooden treads of the staircase's second flight and would therefore have had to be built at the same time as the latter (see Appendix 4: I).

⁵¹ This is to be expected if most of the partition wall between CR-ER, in which the wooden treads of the second flight of the staircase would have been inserted, had only started being built (*supra* and n. 49).

⁵² In this case, the ‘large part of a mudbrick’ found against the opening’s east face may simply be a fallen mudbrick rather than part of a door frame consisting of mudbricks, as assumed by the excavators (Popham et al. 1993, 6), especially since all the other door frames, traces of which were found in the building, were made of wood.

characterised by the wind speed and the earthquake ground acceleration that correspond to a 2% chance of occurrence in any given year, a standard method for assessing hazard intensity in engineering.

A timber frame construction allows it to withstand both vertical (gravity) and lateral loads resulting from wind or earthquake forces. Gravity loads primarily stem from the weight of the roofing material (thatch), transferred from the battens through the rafters and ridge beam to the posts, which could lead to post buckling. Wind can exert both downward and upward pressures on the roof, necessitating its ability to withstand both. The downward pressures due to winds perpendicular to the longitudinal axis of the building are transferred as a horizontal load on the top of the posts, making them susceptible to bending failure or overturning due to soil failure. Similar horizontal effects occur during earthquakes, where inertial forces are largely induced by the weight of the thatch. In this sense, the wall- and veranda posts were intentionally designed to have a plank-like shape and be oriented so as to be parallel to the long axis of the building in order to act as ‘spades’ and thus maximise resistance to soil failure rather than being perpendicular to the building’s long axis to resist snapping due to lateral loads. Therefore, the veranda, a precursor of the peristyle of Greek temples, was a fundamental component of this large-scale timber-frame structure and did not simply serve to increase the size of the LK-T building and invest it with what Vitruvius called *auctoritas* (i.e. grandeur, imposing effect) or to protect against rain and sun.⁵³

Although there is no definitive evidence of significant structural failure or deformation of the timber frame, we identified wind uplift as the most probable damage mechanism. Negative wind pressures could have uplifted the thatch, the roof, or the entire frame, with the former being significantly more likely. The traces of thatch found on the building's floor could be indicative of partial uplift, with the remaining thatch, found in the fill of the building, having possibly been dismantled during the filling operations. Another failure scenario involves the frame overturning due to horizontal forces, whether from wind or earthquake, with wind being the more likely cause. Our conservative analysis suggests that such a scenario would be possible given the intensity of the wind hazard considered. However, we did not account for horizontal load transfer elements, such as diagonal bracing. Moreover, if such a scenario occurred, significant structural damage would likely be evident, which is not the case. Other frame-damaging mechanisms, such as centre post buckling or rafter breakage, appear less likely.

Finally, had the exterior walls been fully erected, they would have increased the structure's stiffness and overall resistance to lateral wind forces, even if in such an event the wall posts merely leaned against them. In the event of an earthquake, the stone socle of the walls, composed of unreinforced masonry, would be prone to high inertial forces, potentially explaining the damage observed, unless the latter is to be attributed to the filling operations of the building or modern bulldozing over this area. In this regard, it is crucial to consider the possibility that earthquakes, in a seismic hazard zone such as Euboea, could have occurred during the building's lifespan or after its abandonment.

CONCLUSIONS

The LK-T building was a timber-framed structure, rather than a building with load-bearing walls, as had been considered until now. This raises the possibility that the walls, perhaps even parts of the frame and roof (such as a partition wall and a superincumbent loft in the ER, a likely mezzanine in the CR, as well as the frame and roof at the west end of the building), were still under construction, rather than fully completed as previously assumed, when the decision was made to abandon the site.

As a timber-framed structure, the LK-T megaron provides us with valuable insights into ancient wooden architecture, including the craftsmanship and techniques of square timber-framed construction, as well as the complex of reasons behind the use of designs of this kind as prototypes for later large-scale temple architecture in Greece. Our analysis has shown that the production and installation of the wooden frame must have involved high-level carpenters. The use of ‘squared’ timbers implies quite advanced carpentry skills and tools capable of yielding precision-made carved joints. In addition, the earthfast posts served as pile foundations, anchoring the frame to the ground and increasing its resistance to lateral wind loads, the wall- and veranda posts playing an important role in this regard through their exceptional shape and orientation;

⁵³ Vitruvius, *De Architectura* 3.3.9, on the *raison d'être* of the *pteroma* or peristyle of the Greek temple; see also Popham *et al.* 1993, 58-9. Another practical function of the veranda could have been the storage of firewood (cf. the suggested function of the ‘(pseudo-)buttresses’ around the Danubian Neolithic houses – Appendix 1: B.2.1); cf. also Sobon and Schroeder 1984, 173).

especially the veranda posts, forerunners of the peristyle of the Greek temple, would have contributed greatly to the overall strength of the framework. The end-result would be a well-executed, sophisticated, and solid frame for this high-standard building. There is no evidence that the timber frame has suffered any significant structural failure, but if such failure ever occurred, it could be due to high winds acting upon the roof, most likely causing a partial uplift of the thatch.

ACKNOWLEDGEMENTS

The authors would like to express their sincere gratitude to †Dr A. Baggs ARB, Mr J. Moreira ARB, Dr R. M. Foster, Prof. C. R. Calladine, Dr. K. Lagouvardos, Prof. J. Jackson, Dr. M. DeJong, Prof. C. Varotsos, Prof. A. Papadopoulou, Prof. M. Diamantopoulou, Prof. M. Skarvelis, Prof. G. Mantanis, Dr D. Zianis, Prof. H. B. Voulgarides, Prof. P. Trigas, and Ms K.-N. Katsetsiadou for valuable advice and information on various issues discussed. I.K. gratefully acknowledges the support by the German Research Foundation (DFG) [Project No. 491258960], Darwin College and the Department of Engineering, University of Cambridge.

REFERENCES

- Acland, J. H. 1972. *Medieval Structure: The Gothic Vault* (Toronto).
- Aravantinos, V. 1997. 'Θήβα. Οικόπεδο Αρχαιολογικού Μουσείου Θηβών', *ArchDelt* 52 (B'1), 353-9.
- Aravantinos, V. 1998. 'Θήβα. Οικόπεδο Αρχαιολογικού Μουσείου', *ArchDelt* 53 (B'1), 323-7.
- Aravantinos, V. and Psaraki, K. 2012, 'Mounds over Dwellings: The Transformation of Domestic Spaces into Community Monuments in EH II Thebes, Greece', in E. Borgna and S. Müller Celka (eds), *Ancestral Landscape. Burial mounds in the Copper and Bronze Ages (Central and Eastern Europe – Balkans – Adriatic – Aegean, 4th-2nd millennium B.C.). Proceedings of the International Conference held in Udine, May 15th-18th 2008* (Lyon), 401-13.
- Bayford, A. 2001. 'The Management and Conversion of Timber for Building', *The Newsletter of the Suffolk Historic Buildings Group* 18, 11-14.
- Blegen, C.W. 1952. 'Two Athenian Grave Groups of about 900 B.C.', *Hesperia* 21.4, 279-94.
- Brock, J.K. 1957. *Early Greek tombs near Knossos* (Cambridge).
- Brown, R.J. 1986. *Timber-Framed Buildings in England* (London).
- Brunskill, R. 1992. *Traditional Buildings of Britain* (London).
- Brunskill, R. 1994. *Timber Building in Britain* (London).
- Calligas, P.G. 1984-1985. 'Ανασκαφές στο Λευκαντί Ευβοίας, 1981-1984', *Αρχαίον Ευβοϊκών Μελετών* 26, 253-69.
- Calligas, P.G. 1988. 'Hero Cult in Early Iron Age Greece', in R. Hägg, N. Marinatos and G. C. Nordquist (eds), *Early Greek Cult Practice* (Stockholm), 229-34.
- Clifton-Taylor, A. 1962. *The Pattern of English Building* (London).
- Coucouzeli, A. 1994. *The Lefkandi Toumba Building and Social Organisation in Early Iron Age Greece* (unpublished PhD thesis, University of Cambridge).
- Coucouzeli, A. 1999. 'Architecture, Power and Ideology in Dark Age Greece: A New Interpretation of the Lefkandi Toumba Building', in R. F. Docter and E. M. Moormann (eds), *Proceedings of the XVth International Congress of Classical Archaeology, Amsterdam, July 12-17, 1998* (Amsterdam), 126-9.
- Coucouzeli, A. 2004. 'From Tribe to State in Early Iron Age Greece: The Archaeological Evidence from Lefkandi and Zagora', in N. Stambolidis and A. Giannikouri (eds), *Proceedings of the International Symposium "The Aegean in the Early Iron Age", Rhodes 1-4 November 2002* (Athens), 461-80.
- Coudart, A. 1998. *Architecture et société néolithique. L'unité et la variance de la maison danubienne* (Paris).
- Coulton, J.J. 1988. 'Post Holes and Post Bases in Early Greek Architecture', *Mediterranean Archaeology* 1, 58-65.
- Crielaard, J.P. and Driessen, J. 1994. 'The Hero's Home: Some Reflections on the Building at Toumba, Lefkandi', *ΤΟΠΟΙ* 4.1, 251-67.
- Deshayes, J. 1960. *Les Outils de Bronze, de l'Indus au Danube (IVe au IIe millénaire)* (Paris).
- Drerup, H. 1969. *Griechische Baukunst in geometrischer Zeit (Archaeologia Homerica II. O; Göttingen)*.
- Fageström, K. 1988. *Greek Iron Age Architecture: Developments through changing times* (Studies in Mediterranean Archaeology 81; Göteborg).
- Flinders-Petrie W.M., 1917. *Tools and Weapons: illustrated by the Egyptian Collection in University College, London* (London).
- Forrester, H. 1975. *The Timber-framed Houses of Essex* (London).
- Gaitzsch, W. 1980. *Eiserne römische Werkzeuge* (BAR International Series 78; Oxford).
- Glendenning, S.E. 1948. 'Local Materials and Craftsmanship in Norfolk buildings', *The South-Eastern Naturalist and Antiquary* 53, 15-25.
- Hall, N. 1988. *Thatching: A Handbook* (London).

- Hansen, H.J. (ed.) 1971. *Architecture in Wood: a history of wood building and its techniques in Europe and North America* (London).
- Harris, R. 1979. *Discovering Timber-framed Buildings*, 2nd edn (Princes Risborough).
- Harris, R. 1980. *Timber framed buildings: A catalogue written by Richard Harris to accompany the touring exhibition Timber Framed Buildings* (London).
- Herdt, G. 2015. 'On the Architecture of the Toumba Building at Lefkandi', *BSA* 110, 203-12.
- Hewett, C.A. 1980. *English Historic Carpentry* (London and Chichester).
- Hijmans, S. 2003. 'The Metal Finds', in H. R. Reinders and W. Prummel (eds), *Housing in New Halos: a Hellenistic Town in Thessaly, Greece* (Lisse), 123-38.
- Hodge, A.T. 1960. *The Woodwork of Greek Roofs* (Cambridge).
- Kakaras, I. 2013. *Τεχνολογία ξύλινων δομικών κατασκευών* (Athens).
- Kostoglou, M. 2008. *Iron and steel in Ancient Greece: artefacts, technology and social change in Aegean Thrace from Classical to Roman times* (BAR International Series 1883; Oxford).
- Liddell, H.G. and Scott, R. 1996. *A Greek-English Lexicon* (Oxford).
- Lotay, Y. 2015. 'Wind Induced Damage to Roofs and Mitigations: A Comparative Study on Roofs in Bhutan and Japan' (Report presented to the Asian Disaster Reduction Center) (available online <https://www.adrc.asia/aboutus/vrdata/finalreport/2014B_BTN_fr.pdf> accessed October 2023).
- Mazarakis-Ainian, A. 1997. *From rulers' dwellings to temples: architecture, religion and society in Early Iron Age Greece (1100-700 BC)* (Jonsered).
- Mazarakis-Ainian, A. 2006. 'The Archaeology of Basileis', in S. Deger-Jalkotzy and I. S. Lemos (eds), *Ancient Greece from the Mycenaean palaces to the Age of Homer; Third A.G. Leventis Conference, The University of Edinburgh, 23-26 January 2003* (Nicosia-Edinburgh), 181-211.
- Mazarakis-Ainian, A. 2012. 'The form and structure of Euboean society in the Early Iron Age based on some recent research', in *Alle origini della Magna Grecia: mobilità, migrazioni, fondazioni: atti del cinquantesimo convegno di studi sulla Magna Grecia* (Taranto), 73-99.
- Meiggs, R. 1982. *Trees and timber in the ancient Mediterranean world* (Oxford).
- Mercer, H.C. 1951. *Ancient Carpenters' Tools Together with Lumbermen's, Joiners' and Cabinet Maker's Tools in Use in the Eighteenth Century. Illustrated and Explained* (Doylestown, PA).
- Oliver, P. (ed.) 1997. *Encyclopedia of Vernacular Architecture of the World* (Cambridge).
- Orlandos, A. 1959-60. *Ta ulika dōmēs tōn archaiōn Ellenōn*. Part 2 (Vivliothēkē tēs en Athēnais Archaiologikēs Hetaireias 37; Athens).
- Orlandos, A. 1966. *Les matériaux de construction et la technique architecturale des anciens Grecs*. Part I. (Paris).
- Pleiner, R. 1969. *Iron Working in Ancient Greece* (Prague).
- Popham, M.R., Sackett, L.H. and Themelis, P.G. (eds) 1979. *Lefkandi I: The Iron Age* (London).
- Popham, M.R., Touloupa, E., and Sackett, L.H. 1982. 'The Hero of Lefkandi', *Antiquity* 56, 169-74.
- Popham, M.R., Calligas, P.G., and Sackett, L.H. (eds) 1993. *Lefkandi II. The Protogeometric Building at Toumba Part 2: The Excavation, Architecture and Finds* (London).
- Popham, M.R. and Lemos, I.S. 1996. *Lefkandi III. The Toumba Cemetery. The Excavations of 1981, 1984, 1986 and 1992-4. Plates* (Athens).
- Roofing, n.d. International Correspondence Schools. Instruction article 513 (London).
- Schattner, T.G. 1990. *Griechische Hausmodelle. Untersuchungen zur Frühgriechischen Architektur* (Berlin).
- Singer, C., Holmyard, E.J., and Hall, A.R. (eds) 1954. *A History of Technology*, vol. I: *From early times to fall of ancient empires* (Oxford).
- Singer, C., Holmyard, E.J. and Hall, A.R. (eds) 1956. *A History of Technology*, vol. II: *The Mediterranean civilizations and the Middle Ages, c. 700 B.C. to c. A.D. 1500* (Oxford).
- Snodgrass, A.M. 1971. *The Dark Age of Greece: an archaeological survey of the eleventh to the eighth centuries BC* (Edinburgh).
- Sobon, J. and Schroeder, R. 1984. *Timber frame construction: all about post and beam building* (Pownal, Vt.).
- The Thatcher's Craft* 1961. The Rural Industries Bureau, Publication 69 (London).
- Touchais, G. 1982. 'Chronique des fouilles et découvertes archéologiques en Grèce en 1981: Lefkandi', *BCH* 106, 529-635.
- Ulrich, R.B. 2007. *Roman woodworking* (New Haven).
- West, T. 1971. *The Timber-frame House in England* (Newton Abbot).
- Whitley, J. 1991. *Style and Society in Dark Age Greece. The changing face of a pre-literate society 1100-700 BC* (Cambridge).
- Wilson Jones, M. and Georg Herdt, G. 2022. 'Virtual Collapse? Considerations of Structure in Reconstructing Greek Architecture' in Borbonus, D. and Dumser, E. A. (eds), *Building the Classical World* (Oxford), 189-217.
- Wood Handbook: Wood as an Engineering Material*, 2010. U.S. D. A., Forest Service, General Technical Report FPL-GTR-190 (Madison, WI).
- Zwinger, K. 2015. *Wood and Wood Joints. Building Traditions of Europe, Japan and China* (Basel).

APPENDIX 1

WHAT IS A TIMBER-FRAMED STRUCTURE? A BRIEF SURVEY

by Alexandra Coucouzeli

INTRODUCTION

In the mainstream History of Ancient Greek and Roman Architecture, as indeed in the mainstream History of Architecture, the emphasis is on stone construction and its various monumental and magnificent examples. There is almost no mention of timber construction and, more specifically, of timber-framing. The reasons for this omission are: the perceived relevance of other ancient Greek and Roman building techniques, the idea of timber as a ‘humble’ material, and the scarcity of evidence, which impedes a comprehensive knowledge and understanding of the ancient timber-framing method. Concerning the scarcity of evidence, this is both material and literary. Timber-framed buildings are rarely attested in the archaeological record, because wood is among the least recorded and the most silent building materials, being highly perishable (with the exception of those cases where its conservation was favoured by specific conditions of water saturation, dry climate or fire). Most of the time, the remains of wood are not preserved and are difficult to identify during archaeological excavations. Thus, all that one usually finds from an ancient timber-framed building is foundation remains, i.e. post-holes, easily distinguishable by their dark stains in the subsoil, or foundation trenches; this evidence, in conjunction with models of houses fashioned in clay and an abundance of ethnographic parallels, all considered together, help us to reconstruct the structure and the general appearance of a timber-framed building. Moreover, there is a scarcity of ancient written testimonies on timber-frame construction. Thus, Vitruvius, in his *De Architectura*, mentions timber-frame structures, but does not provide any great details about them and, moreover, he uses a disparaging tone (*infra*). One assumes that, in antiquity, the technical knowledge of the timber frame method was passed down from generation to generation by carpenter-builders and their craftsmen during their work *in situ* rather than through carpentry manuals or written texts.

However, timber-frame construction deserves a far more prominent place than it has hitherto been assigned, because of its ancient origins, its large dissemination around the world, and its persistence in the history of building construction. Indeed, more than any other form of building, timber frame construction goes far back in time. As early as the Neolithic period, people in all parts of the world where suitable trees were available in sufficient numbers resorted to making wooden frames. Thus, timber framing is the most common construction technique utilized by many builders around the world throughout history. Even when people started building in stone, they still simulated the designs of their earlier timber work, the best-known example of this being the apparent translation of the wooden structural elements in early Greek temple architecture into the stone construction that reached its apogee, both technical and aesthetic, in the classical temples of Athens, as first shown by Vitruvius (*De Architectura*, 4.2.1-5).

In what follows, I shall try to give a brief overview of timber-framed structures. After outlining their differences from structures with load-bearing walls, as well as their various types and the methods used to ensure their stability in vernacular architecture, I will present a series of examples that allow us to trace their historical development from Antiquity to modern times.

A. STRUCTURES WITH LOAD-BEARING WALLS *VS* TIMBER-FRAMED STRUCTURES

‘Architecture is shelter. No roof ... no building. At its very root and source, architecture always has been the shaping of packages of space which insulate or isolate the occupant from undesirable facts of environment ...’ (Acland 1972, 4). To meet this demand, builders devised two major and contrasting structural systems: ‘mass construction’ and ‘frame construction’ (Acland 1972, 4 ff.; see also Brunskill 1987, 34), also referred to as ‘massive system’ and ‘skeleton system’ (Norberg-Schultz 1966, 162-5) or simply as ‘mass walling’ and ‘framing’.¹

¹ Oliver 1997, 2177 (s.v. ‘Framing/framework’), 2186 (s.v. ‘Timber framing’).

A.1. Mass construction or Massive system

In this type of structural system, mass walls transfer the roof loads to the foundation of the building. These load bearing, mass walls, which form a homogeneous outer surface, also provide a protective envelope against adverse weather conditions (rain, snow, wind, cold, extreme heat) and, therefore, they function simultaneously as structure and as insulation

(Acland 1972, 4). Thus, the mass system is also defined as consisting of elements that are both ‘supporting’ and ‘bounding’ (Norberg-Schultz 1966, 163). In vernacular architecture, massive construction is characteristic of regions where building timber is a scarcity (Acland 1972, 4).

So far as materials are concerned, the massive system works primarily with stone, earth, adobe (in the form of puddled clay or of sun-baked bricks/mudbricks) and fired bricks, but it can also consist of timber logs (set horizontally) (Oliver 1997, 649-50).

Stability in mass construction

‘The mass wall is a type of continuous wall structure fundamentally based on the static principle of the heavy system, with materials placed one on top of the other, achieving structural stability through the weight stemming from the progressive accumulation of loads. Practically, this means that the capacity of the structure to remain solidly anchored to the ground depends on the total weight exerted on the foundation, which in turn must be capable of offering the necessary resistance to provide equilibrium. The specific gravity of the material used is usually the main static factor determining the form [of the mass wall].’ (Oliver 1997, 649-650).

The problem of achieving stability in buildings with walls made of stone, which, in vernacular architecture, are usually of rubble masonry, composed of irregular and unhewn field stones and therefore of reduced resistance, is solved by using thick walls. Especially in buildings with walls made of separate pieces of materials (such as, e.g., a socle of stone and a superstructure of mudbricks) and with tall, long walls, this problem is commonly solved by the use of large boulders at the base, which help to stabilise the foundations, while the risk of collapse by outward buckling of such walls is compensated by the use of cross walls, which make it possible to divide a long, narrow plan into self-buttressing squarish cells, sometimes also by introducing wooden beams between the courses of the walls as reinforcement.²

A.2. Frame construction or Skeleton system

In this type of structural system, which also characterizes all timber-framed buildings, the structure is a skeletal armature and all loads from the roof to the foundation are carried by an ‘active’ frame, which concentrates these loads and transmits them to points on or in the ground (Acland 1972, 4; Brunskill 1987, 34; Oliver 1997, 254), while there is also a protective envelope or cladding, which is non-load-bearing and acts primarily as insulation against the rigours of the weather but also against fire and inimical acts (of course, the more the protective screen is solidly built, the more it protects against these hazards). The cladding can be either *detached from the frame, i.e. stand independent of the frame* and form by itself the walls of the structure or it can constitute *a single body with the frame* and form with it the walls of the structure. Expressed differently, the skeleton system consists of ‘supporting’ elements, which form a frame and play a primary role having a structural function, *and* of ‘bounding’ elements, which form protective enclosing surfaces and play a secondary role having no structural function, the two being independent of each other from the point of view of their functions, in contrast with the massive system (Norberg-Schultz 1966, 164). It is also worth noting that in the skeleton system the openings (such as windows and doorways) participate in the whole structure by being incorporated directly into the frame, as opposed to being ‘relatively accidental perforations’ in the massive system (Norberg-Schultz 1966, 164; see also Harris 1979, 25-6). In vernacular architecture, frame construction is characteristic of forested regions (Acland 1972, 4).

As regards the ‘supporting’ elements of the skeleton system, in general these are primarily made of wood. In vernacular architecture, they are *always* made of wood and present various forms, which are as follows: ‘sticks’, i.e. branches, requiring a minimum of conversion from the primary source of the material to its placement in the frame (‘stick-frame’) (Oliver 1997, 257-8); ‘poles’, i.e. round, naturally shaped timbers

² Brunskill 1987, 35, 37. For the technique of the insertion of horizontal timbers into the coursing of the walls as reinforcement in Greece from prehistoric (Minoan) to modern times, see Tsakanika 2017, 268-72; 2018, 12.

(round logs) that come from tree trunks with minimal conversion or 'dressing' of the material (removal of the bark and secondary branches, sometimes also of the sapwood to prevent decay) prior to placing in the frame ('pole-frame') (Oliver 1997, 253-4), a process that does not require skilled workmanship; 'riven timbers', i.e. pieces of timber, often square or rectangular in section, converted for the framed building from a tree trunk by splitting, a process requiring skilled workmanship and knowledge of timber (Nabokov and Easton 1989, 246-7; Oliver 1997, 255); 'columns', i.e. timbers of a round cross-section, converted from a tree trunk by trimming, smoothing, and making straight to the line, a process requiring good carpentry skills and knowledge of timber; and 'squared timbers', i.e. timbers of a 'square' cross-section (the term 'square' being here used loosely to mean a square, rectangular or polygonal cross-section) converted from a tree log by sawing, squaring, trimming, smoothing, and making straight to the line prior to placing in the frame ('square-timber frame'), a laborious and time-consuming process of conversion (Oliver 1997, 255-6) requiring good carpentry skills, a greater knowledge of timber and more sophisticated tools.

The connections used in vernacular architecture to attach the framing members to one another are: either rudimentary binding by means of lashings made of vegetal materials in stick-frames and commonly also in pole-frames (except if they are combined in the latter case, more rarely, with crude carved joints permitting a better attachment of the structural members to each other); or a complex range of sophisticated and precise carved joints, a stronger type of connection (since right-angles fit better) requiring specialised, carpentry skills in square-timber frames.

As for the 'bounding' elements, i.e. the protective enclosing surfaces of the skeleton system, in vernacular architecture, these can be: either *movable and of a non-permanent nature*, made of light materials that can be easily dismantled and moved if necessary, such as mantles of vegetal substances – leaves, bark, (intertwined) reeds, rushes, brushwood, or (woven) bamboo – or mantles of animal hides or of fabrics; or *non-movable and of a permanent nature*, made of wattle and daub, plastered laths, lattice, planks, mud, withies and mud, pisé, adobe (in the form of puddled clay or of mudbricks), fired bricks, stones, etc.

Stability in frame construction

Unlike stone, a heavy material that can only withstand pressure (*supra*), wood is not very heavy, and it can withstand the various stresses of bending, tension, compression or shear (Hansen 1971, 121, 225; *Wood Handbook*, 5–3).

In the history of vernacular architecture, the main method used to ensure the stability of a timber frame structure, especially its resistance to lateral wind pressure, pertains to the way in which its load-bearing posts are placed with respect to the ground. In this regard, the general trend is to move from posts embedded in the ground to posts raised off the ground (Fig. A1:1), two distinctly different ways of setting up a post, the latter requiring some additional structural solutions (Hansen 1971: 69-72; West 1971: 21, 102-103; Acland 1972: 14; Coulton 1988, 58; Audouze and Büchenschütz 1992, 56-62; Brunskill 1994: 20-26; Oliver 1997, 254, 650; Zwerger 2015: 23, 79, 153). More analytically:

The simpler and more ancient arrangement, that of embedding the posts in the ground, characteristic of most pole-frame buildings (Oliver 1997, 254), consists in placing the posts of the frame in specially dug pits (or in a trench), which are then backfilled with earth (and sometimes other filling material, such as clay, gravel or pebbles, stones, sherds etc.) rammed tightly around the foot of the post (Fig. A1:1a). The rammed earth functions as a vertical bracket firmly fixed to the foot of the post giving to the latter a cantilever effect, thereby increasing its structural strength and resistance to lateral wind-forces. In this manner, embedded timber posts act like a (wood) pile foundation – a type of deep foundation used to support a structure and transfer its structural loads into the ground at a desired depth; therefore, the embedded posts, in addition to serving as the main, vertical members of the frame, serve as the foundation of the structure (*Wood Handbook*, 7–14, 17–4). And, as Coulton notes, 'Posts set in holes ... can not only transmit a downward force (the necessary resistance is provided because the material at the bottom of the hole is more compacted and harder to displace than that at the surface); they can also resist a substantial sideways, or even (thanks to the adhesion of the earth to the sides of the post) an upward, force.' (Coulton 1988, 58).

Timber-framed buildings with earthfast posts and an elongated (rectangular, apsidal or oval) plan may have an axial row of posts supporting a ridge beam that carries the main weight of the roof and two or four

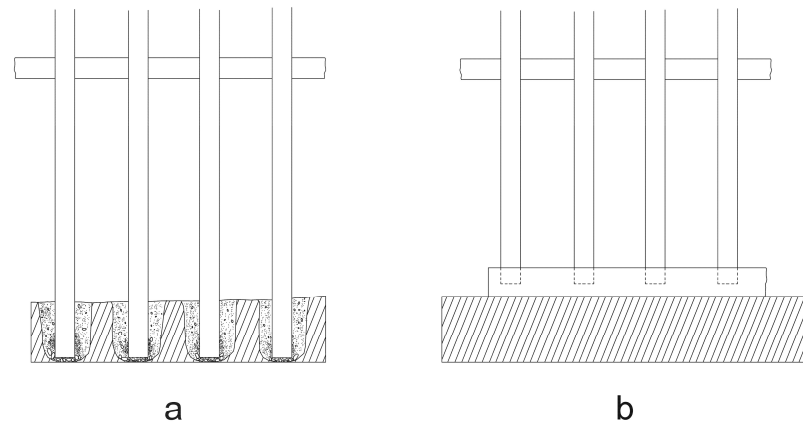


Fig. A1:1. Two distinctly different ways of setting up a post in a timber frame:
 (a) Posts embedded in the ground; (b) posts raised off the ground (adapted from West 1971, fig. 3).

lateral rows of posts, thus forming two-aisled or four-aisled buildings, respectively (Fig. A1:2*ab*). In this case, all the posts are linked to each other longitudinally (i.e. in the direction of the long axis of the building) by means of ‘plates’ (or ‘wall-plates’) joining their tops and therefore necessitating careful longitudinal alignment of the posts, irrespective of their spacing, which can be irregular (Fig. A1:2*c*), as part of a ‘prop-and-ridgepole’ (or ‘column-and-ridgepole’) roof construction.³ The use of longitudinal linkage, whether the connections are made of lashings or carved joints, is in principle sufficient, rendering the use of transversal linkage, via crossbeams tying together opposite posts in the lateral rows, basically superfluous for the stability of the structure; indeed, crossbeams fixed to the axial posts can be used to connect the opposite plates together, but they do not play an essential role in counteracting the lateral thrusts, since in this system all the loads of the roof are exerted vertically downwards (Fig. A1:2*d*) and the structural stability of the wooden frame is ensured simply by burying the posts at the right depths.⁴

Alternatively, timber-framed buildings with earthfast posts may have no axial row of posts, but a double row of posts supporting a series of crossbeams and which may be flanked by two or even four further rows of posts on either side, thus forming single-aisled, three-aisled (Fig. A1:3*ab*) or five-aisled buildings,⁵ respectively. The posts are then connected to each other both longitudinally by means of ‘plates’ (which requires careful longitudinal alignment of the posts, as already mentioned) and transversely (i.e. perpendicularly to the long axis of the building) by means of crossbeams, which tie their tops together and therefore also require a strict alignment of the posts opposite one another (Fig. A1:3*c*), as part of a ‘prop-and-lintel’ (also known as ‘post-and-beam’) roof construction.⁶ In this system, all the loads of the roof are distributed over the posts, well above ground (Fig. A1:3*d*), and the transversal linkage plays an essential role in counteracting the lateral thrusts: the main weight of the roof is transferred down on to the crossbeams, which in turn transfer it to the wall frame, while tying the frame together, thus preventing the wall posts from bulging outwards under the pressure of the roof and ensuring the stability of the frame (Audouze and Büchschütz 1992, 59).

However, the embedding of the posts in the ground has one major drawback: it is not long-lasting, because it exposes the posts to rising damp and rapid decay at the air-ground transition, i.e. where the post

³ This type of roof is based on the principle of rafters carried at their top by a ridge beam, which carries the main roof load and is supported by an axial post, and at their bottom by the plates of the side posts (or walls in mass construction). See Ulrich 2007, 93-4; cf. Zwerger 2015, 176, fig. 378: top (where this type of roof is referred to as the simplest type of the so-called ‘purlin roof’, the ridge beam is called ‘ridge purlin’ and the plate is called ‘inferior purlin’).

⁴ See Audouze and Büchschütz 1992, 56-7, 59, 61-2; Coudart 1998, 62, figs 49, 57-61, 69, 74. This does not mean that transversal linkage is not structurally helpful for the cross-bracing of the timber frame (especially when diagonal struts are used) and it does occur in certain ethnographic examples of pole-framed buildings (e.g. the Wayapi (New Guinea) house (Oliver 1997, 1745 with ill.).

⁵ For an example of a five-aisled timber-framed building, see Guidoni 1987, fig. 77.

⁶ For this type of roof construction, see *infra*, n. 9.

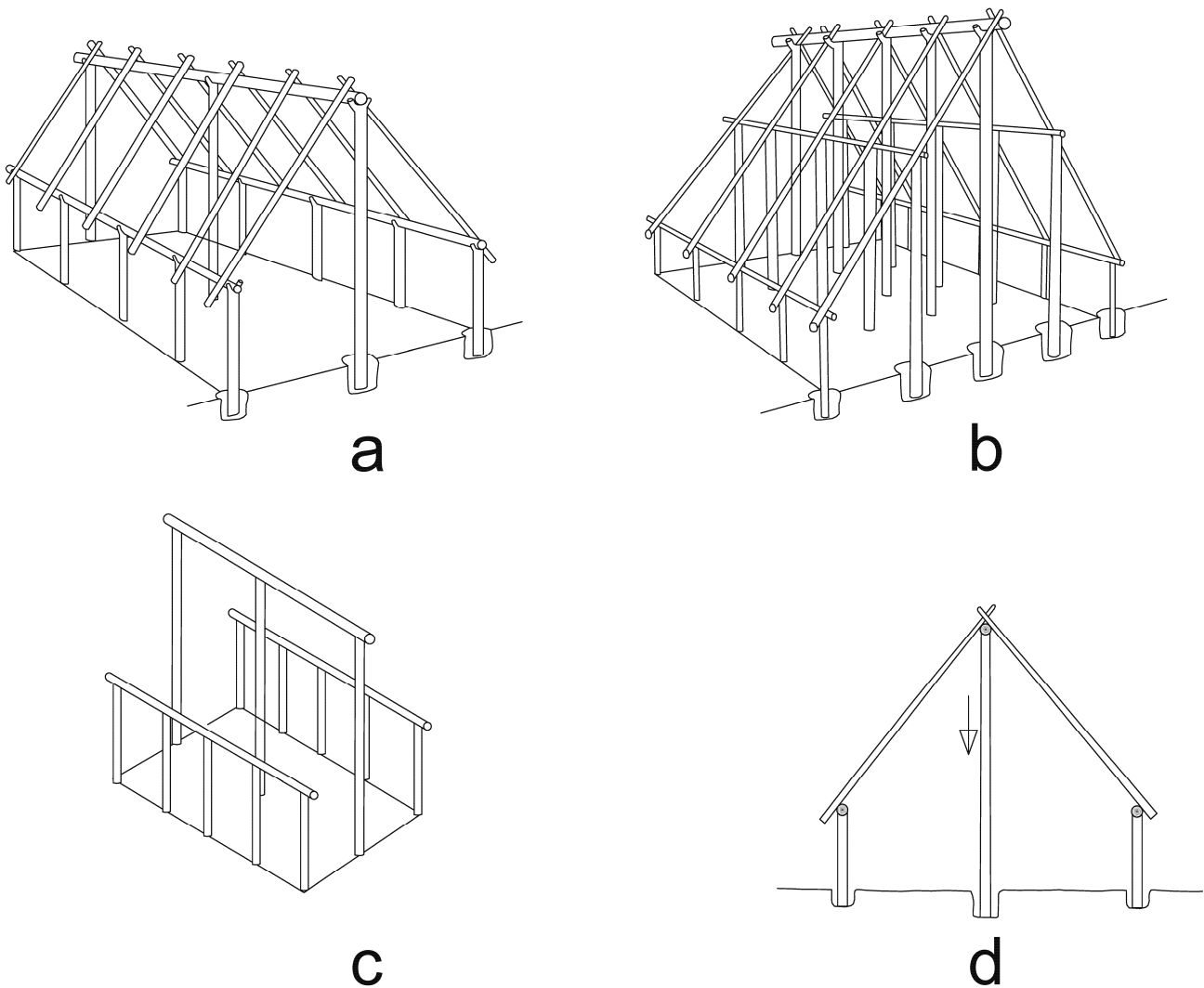


Fig. A1:2. Two-aisled (a) (adapted from Audouze and Büchsenhüt 1992, fig. 27.1) and four-aisled (b) timber-framed buildings with embedded posts as part of a prop-and-ridgepole roof construction using longitudinal linkage; (c) the posts can be placed at irregular intervals, since what matters is their longitudinal alignment (adapted from Brunskill 1994, fig. d6b); (d) in this system, all the loads of the roof are exerted vertically downwards (adapted from Audouze and Büchsenhüt 1992, fig. 36.1).

emerges from the ground, since at that point it is very susceptible to the alternate wetting and drying,⁷ which causes decay, due to dry rot, and therefore suffers most damage thus compromising the structural integrity of a timber-frame building.

A technologically more advanced arrangement used to liberate timber-framed structures from the 'tyranny' of the reliance on decay-prone earthfast posts and give them stability is to lift the posts off the ground and stand them upon a single or a continuous base of stone or brick, with or without the interposition of a wooden sill-beam (Fig. A1:1b) (or, alternatively, upon a wooden platform supported by piles of free-standing posts). The base protects the post from moisture and, at the same time, it spreads the concentrated load transmitted by the post (Coulton 1988, 58). However, since '[p]osts carried on bases offer no resistance to lateral forces [and] they can only resist a downward force' (Coulton 1988, 58), in order to compensate for the ensuing loss of stability and obtain a robust and solidly built timber frame, a variety of complex solutions is used, such as: cross-bracing either in the form of crossbeams as part of a 'prop-and-lintel' (or 'post-and-beam') roof construction⁸ (Fig. A1:4a), or in the form of tie-beams as part of a 'post-and-truss' roof construction (Fig.

⁷ Buried wood rots fastest when it is alternately wet and dry than when it is constantly wet (Coulton 1988, 61 n. 22).

⁸ This type of roof is based on the principle of carrying the roof loads on crossbeams resting on the side posts (or walls in mass construction); the crossbeams may carry queen posts and/or a king post supporting the ridge beam (Figs A1:4a1 and A1:4a2). This

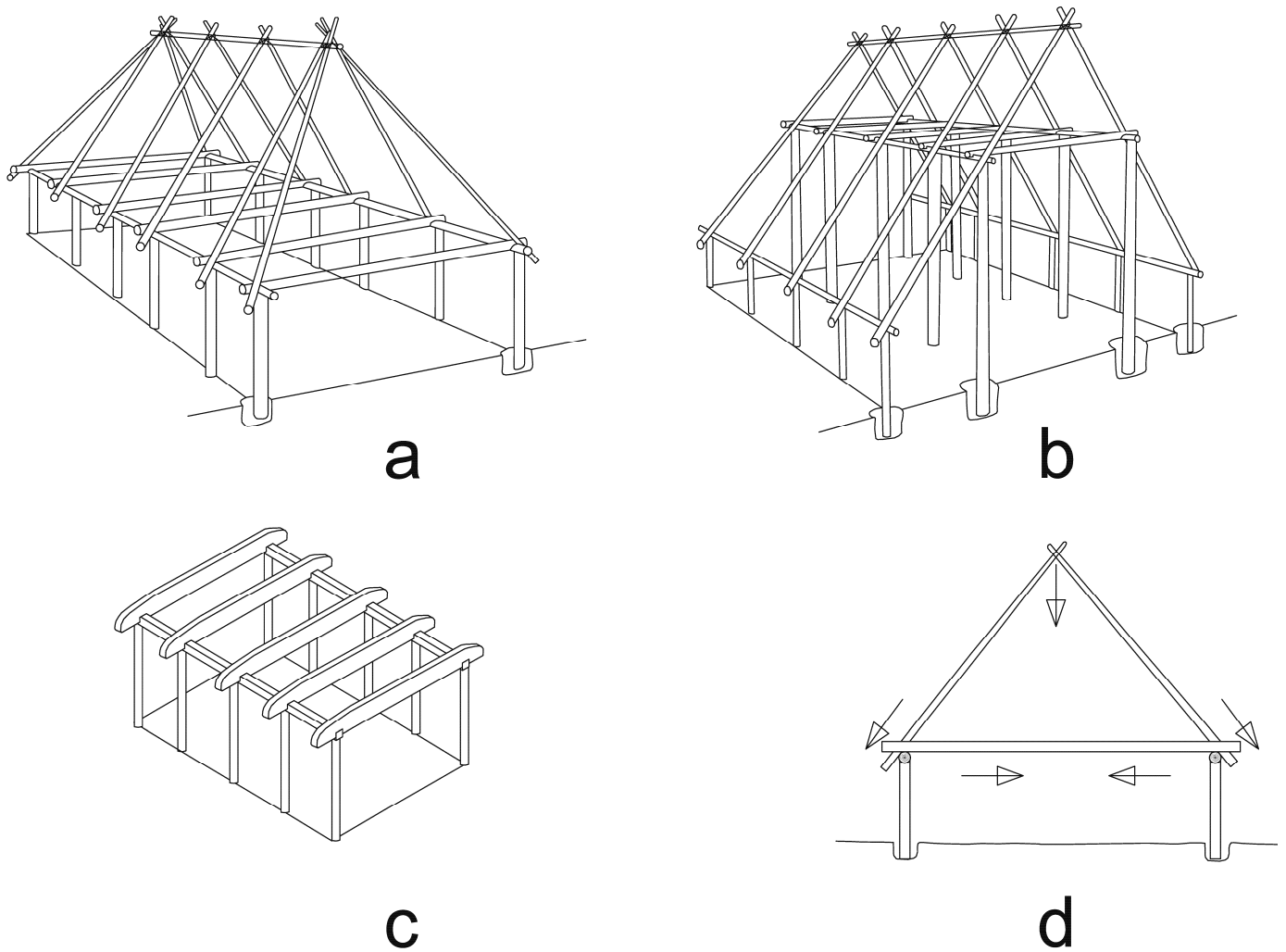


Fig. A1.3. Single-aisled (a) and three-aisled (b) timber-framed buildings with embedded posts as part of a prop-and-lintel (or post-and-beam) roof construction, with use of longitudinal and transversal linkage (adapted from Audouze and Büchenschütz 1992, fig. 27.2 and fig. 27.3, respectively); (c) the posts have to be aligned both longitudinally and transversally (adapted from Brunskill 1994, figs d6a, d6b); (d) in this system, all the loads of the roof are distributed over the posts, well above ground (adapted from Audouze and Büchenschütz 1992, fig. 36.2).

A1:4b), where the frame for the walls and the roof are now completely separated from each other;⁹ both crossbeams and tie-beams provide transversal linkage to stiffen the timber frame: they tie the wall frame

was the traditional roofing system used in ancient Greece (Hodge 1960, 35, 40, 43-4, 47, figs 2, 4, 10b; Ulrich 2007, 125-36, fig. 8.1; cf. Zwerger 2015, 176, 180, 183, figs 378: bottom (where this type of roof is referred to as the more complex type of the so-called 'purlin roof'), 390 (a Japanese example with a single king-post), 393 (a Japanese example with a king post plus queen posts), the latter reminiscent of the roof construction of the Classical Greek temples.

⁹ The truss-roof system is an elaborate system based on the principle of establishing a strong, self-supporting, and stable triangle or 'truss'. A truss is usually formed of a pair of 'principal' rafters (sometimes called 'spars' to distinguish them from the rafters of the 'prop-and-ridgepole' and of the 'prop-and-lintel' or 'post-and-beam' roof construction) pitched against each other in 'couples' and sometimes tied with a horizontal timber or 'collar' to prevent them from spreading; the principal rafters are fixed together at their tops and joined at their base into the ends of a thick tie beam, which resists the lateral thrust of the roof and rests upon the main wall posts; in this way, the principal rafters transfer their loads to the roof truss; the rafters are supported either by purlins (Figs A1:4b1.1 and A1:4b2) or by a crown plate, i.e. a central beam sitting on a crown post carried by the tie-beam (Fig. A1:4b1.2); the tie-beam may sometimes support a king post or queen posts. Thus, the truss-roof system dispenses of the centre post supporting a ridge beam, and the latter may be replaced by a purlin. In timber-framed buildings, this roof system is used with posts standing off the ground and necessitates the perfect alignment of opposite posts for the carrying of the truss (West 1971, 102-3; Brunskill 1992, 93; 1994, 100, figs d6a, d36b; Harris 1979, 6-8, 85-6, figs 2-4, 41, 44; cf. Zwerger 2015, 176, 180, fig. 379, where the truss roof is called 'spar

together, thus preventing the wall posts from bulging outwards (*supra*); lateral bracing, in the form of girding beams (or girt(h)s) or ledges (horizontal timbers linking the wall posts together) and/or of a wooden sill beam upon which the wall posts rest and which has a load-distributing function (Fig. A1:5); diagonal braces (oblique timbers joining the horizontal or vertical members of the timber frame)(Figs A1:4 and A1:5);¹⁰ and complex jointing together of the vertical and horizontal components of the frame (Fig. A1:5).

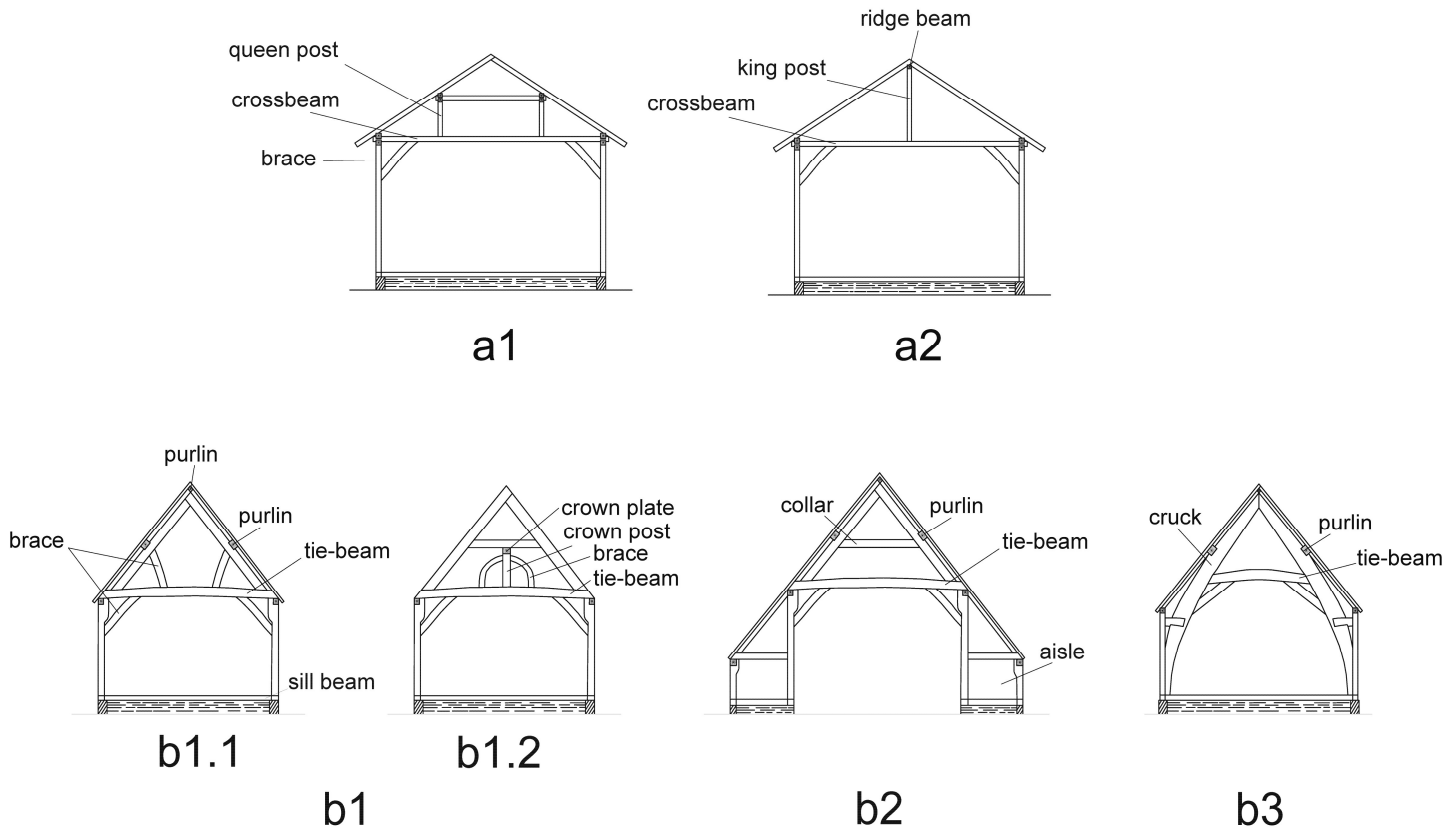


Fig. A1:4. Posts off ground as part of (a) a prop-and-lintel (or post-and-beam) roof construction, with (a1) queen posts (adapted from Zwerger 2015, fig. 378: bottom) and (a2) a king post (adapted from Béa 2013, fig. 9); and (b) a post-and-truss construction: (b1) in a box-framed building, with only a tie-beam (b1.1) (adapted from Harris 1979, fig. 8: middle) and with a crown post (b1.2); (b2) in an aisled building (adapted from Harris 1979, fig. 8: left); (b3) in a cruck building (adapted from Harris 1979, fig. 8: right).

roof' or 'spar truss' and the rafters are called 'spars'). In the 'post-and-truss' roof construction, 'the framing for the walls and the roof were at last completely separated' (West 1971, 102).

¹⁰ Bracing can be of three types: cross-bracing, in the form of crossbeams or tie beams; lateral bracing, in the form of horizontal timbers between the vertical timbers; and diagonal bracing, in the form of 'braces' – a 'brace' is any oblique timber (permanent or temporary) joining horizontal or vertical members of the timber frame to give extra support against lateral wind forces and prevent 'racking' and distortion of the frame; diagonal braces add rigidity to the frame (see Walker and Woeste 1992, 15; Brunskill 1994, 101; *Post frame building design manual*, 1–6).

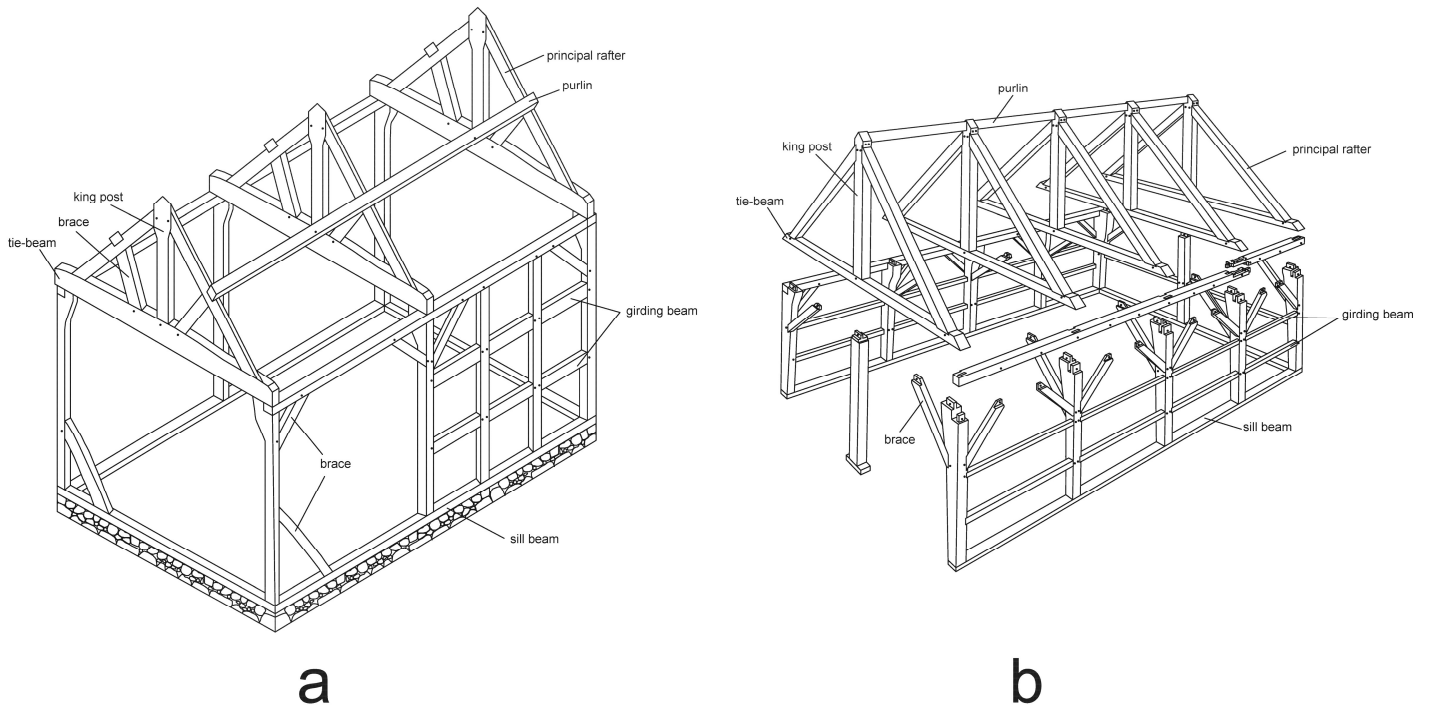


Fig. A1:5. Posts off ground, post-and-truss construction, lateral bracing, diagonal braces, and complex jointing: (a) Box-frame building (adapted from Brunskill 1992, figs 48*d* and 48*f*); (b) Timber-framed barn built with squared timbers (adapted from Sobon and Schroeder 1984, 170).

Other methods used to achieve the structural equilibrium of a timber-framed building, especially when the latter is detached from the ground, are the shaping of the building to resist wind forces by giving it a hipped roof (Fig. A1:6*a*), by adding aisles (Fig. A1:6*b*) or projecting wings (Fig. A1:6*c*), etc. (Brunskill 1994, 22-3; see also Brunskill 1987, 78-9).

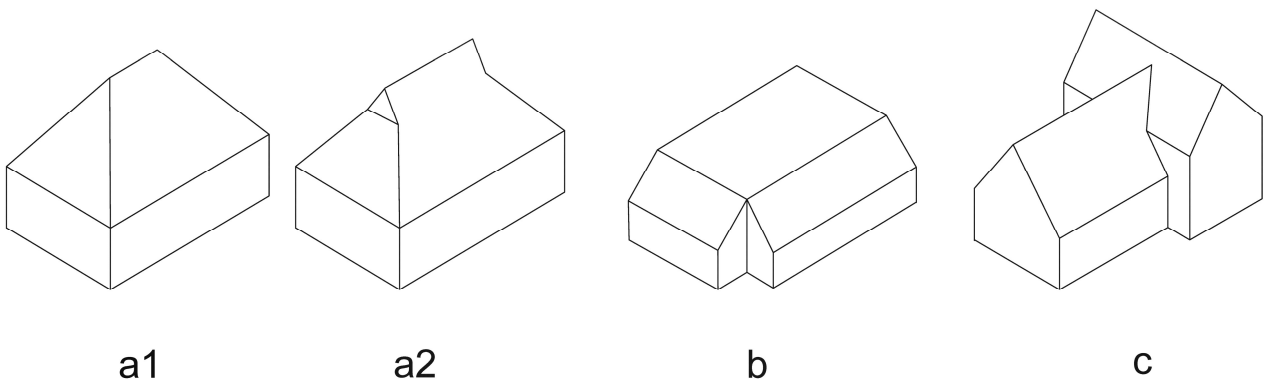


Fig. A1:6. (a) Hipped roof (adapted from Brunskill 1992, fig. 60*a*) or gablet roof combining a hipped roof and a small gable at the top (adapted from Brunskill 1992, fig. 60*b*), (b) aisles (adapted from Brunskill 1994, fig. d4*b*) and (c) projecting wings (adapted from Brunskill 1994, fig. d4*c*) as measures for the resistance of a timber-framed building to the wind.

B. THE GREAT VARIETY OF TIMBER-FRAMED BUILDINGS – SOME EXAMPLES

Given the wide range of solutions used in vernacular frame construction for the timber frame and its cladding as well as for the frame's stability, according to the climatic, physical, and social conditions, the materials,

techniques, and economic resources available, and the intended functions, there is naturally a great variety of timber-framed buildings. In this section, we shall look at some examples drawn both from the ethnographical and the archaeological record.

B.1. Ethnographical examples

The following ethnographic examples fall under four main categories: (I) Elementary timber frame structures, (II) More solidly built, humble timber frame structures, (III) Substantial timber-framed buildings, with external walls, and (IV) Sophisticated timber-framed buildings.

I. Elementary timber frame structures

These are light architectural forms, which can be wholly or partly dismantled and moved when necessary, and which, in their vast majority, rely on earthfast posts for their stability.

Examples of elementary timber frame structures where frame and cladding form a single body are: the makeshift, flimsy round or oval huts of the Sarakatsani (Greece), with a frame of embedded and bent sticks connected with vegetal lashings and a cladding of withies, straw and reeds (Fig. A1:7) (Chatzēmichalē 1957, 157-263; Kouremenos 1984, *passim*); the rectangular single-family ‘barkhouses’ (*gä-no-sote*) or multi-family

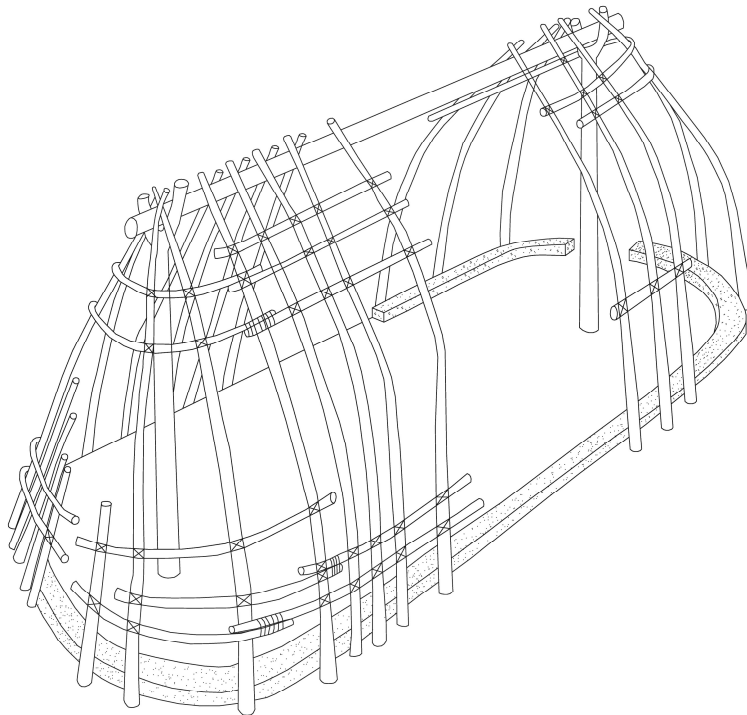


Fig. A1:7. Sarakatsani hut (Greece) (adapted from Chatzēmichalē 1957, fig. 116).

longhouses (*ho-de-no-sote*) of the Iroquois (North America), which were pole-framed structures, with walls made of upright poles embedded in the ground and a cladding of bark boards secured between the poles of the frame and another set of poles corresponding to the latter and placed on the outside (Figs A1:8, A1:9); other earthfast poles, set in two parallel rows along the interior, defined a central corridor and two aisles on either side; the latter were occupied by two-tiered berths or stall-like compartments forming bays and serving as sleeping- and storage spaces for the family members in the single-family houses (Fig. A1:10) or for each of the nuclear families in the longhouses, which could range in length between 10.50 and 120 m; these compartments were secured to the frame and partitioned from one another by means of planks or bark sheets; the vertical poles were tied together by means of horizontal transverse poles and carried the bent saplings of the bark-covered roof; all the connections were made of bark rope fastenings (Morgan 1851, 315-9; 1965, 125

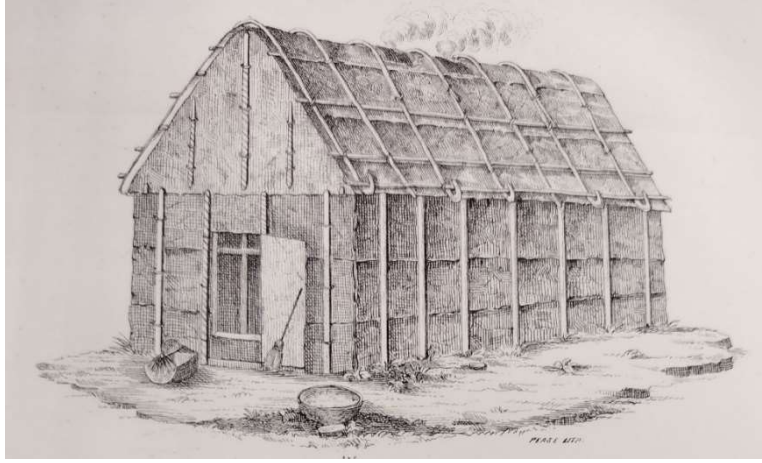


Fig. A1:8. Single-family Iroquois house (*ganosote*), exterior view (Morgan 1851, 3: top).

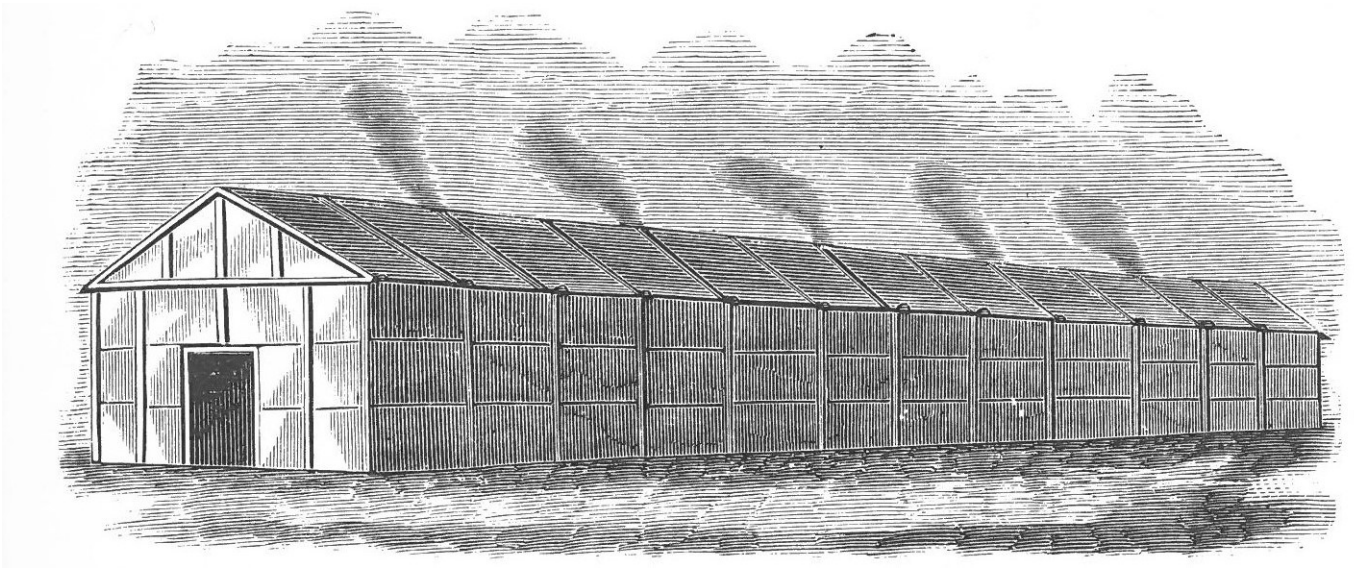


Fig. A1:9. Multi-family Iroquois longhouse (*hodenosote*), exterior view (Morgan 1965, fig. 12).

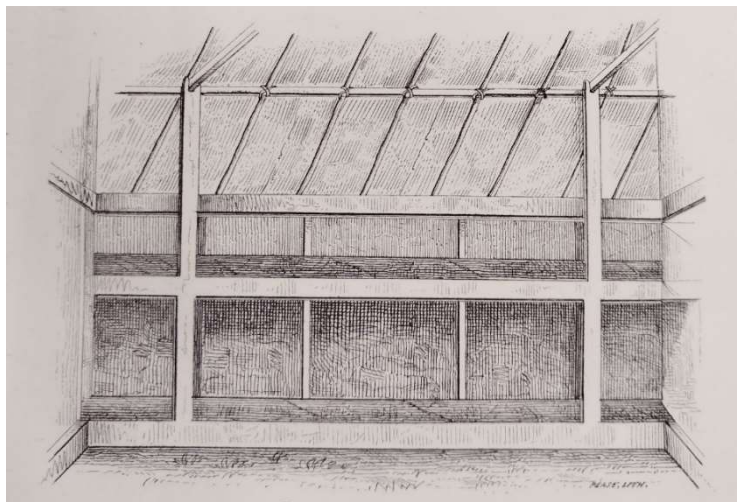


Fig. A1:10. Interior of a single-family Iroquois house (*ganosote*) (Morgan 1851, 3: bottom).

ff., figs 12-14; Nabokov and Easton 1989, 82-4; Coucouzeli 1994, 316-26 with references; 1999; 2004); the rectangular huts (*rukas*) with apsidal ends of the Araucanians (Chile), with a framework of embedded saplings, upon which horizontal cane stalks are tied by means of vines to receive the thatching and form both the

protective envelope of the structure and the roof; a row of axial, forked poles support the ridge beam of the roof (Oliver 1997, 1647 with ill.; Guidoni 1987, fig. 79); the rectangular longhouses (*malocas*) of the Desana (Colombia, Brazil) (Guidoni 1987, fig. 75) or of the Tukano (Colombia) (Guidoni 1987, fig. 77), with walls made of embedded poles for the frame and vegetal materials for the cladding; the elements of the frame are tied together with plant lashings, while a double row of centre poles form part of a post-and-beam construction supporting the ridge beam of the thatched roof; the rectangular longhouses (*umas*) of the Mentawai (Siberut, West Indonesia) (Oliver 1997, 1124 with ill.), where the pole-frame stands above ground (upon an elevated wooden platform supported by stilts) and includes crossbeams that form part of a post-and-beam construction supporting the ridge beam of the thatched roof, while the cladding is made of planks (converted from tree trunks through splitting); the connections used are a combination of vegetal lashings and carved joints (mortise-and-tenon and lap joints); the square or rectangular multi-family dwellings or longhouses of the native people of the Northwest Coast (North America), in the form of large sheds, usually with a frame forming a single body with the cladding and consisting of embedded posts, which are poles (e.g. the Quinault houses) and/or rectangular, riven timbers (e.g. the Haida ‘two-beam house’ or the Nootka, Kwakiutl and Tlingit houses); the side posts carried longitudinal or crossbeams, often jointly with centre posts as part of a post-and-beam construction, for a double-pitched, gabled roof, covered with planks; the connections were made either of vegetal lashings in the pole-framed structures or a combination of lashings and carved joints (mortise-and-tenon and notches) in the square-timber frame structures; the cladding consisted of planks, either vertical (embedded in the ground or tenoned into a sill beam) or horizontal and sometimes removable (and transported to frames at seasonal, summer camps), inserted between pairs of poles and attached with bark ties, like in the Nootka houses; this type of cladding was also characteristic of the Salish houses, which however are an example where the frame was detached from the cladding and consisted of two rows of rectangular, riven timbers embedded at some distance from the walls and carrying the crossbeams of a single-pitched, planked roof by being joined to them with mortise-and-tenon joints (Fig. A1:11).¹¹

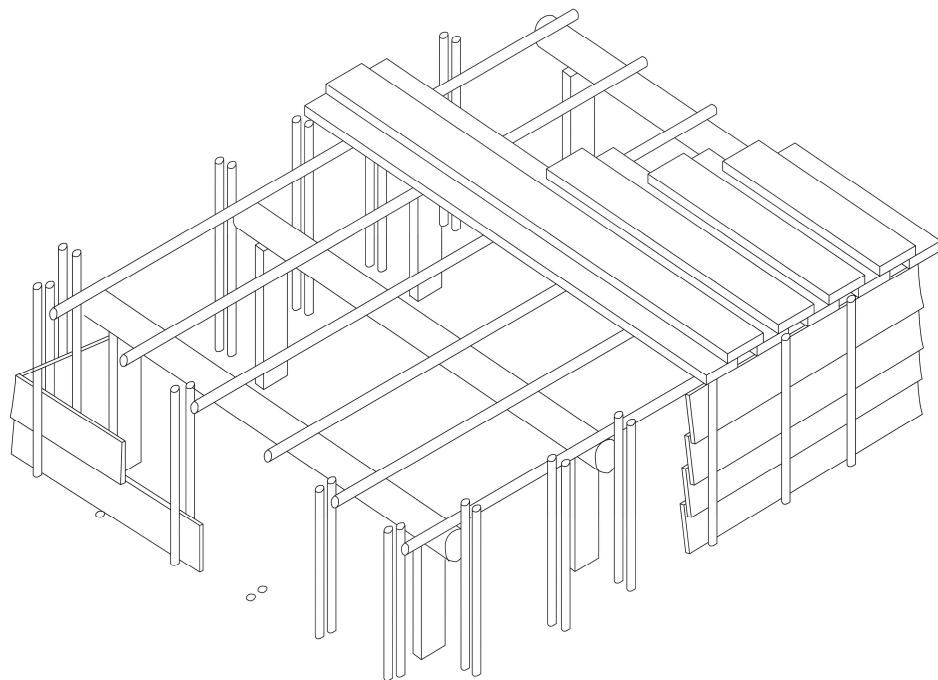


Fig. A1:11. Salish house (Northwest Coast, North America) (adapted from Nabokov and Easton 1989, 236).

II. More solidly built, humble timber frame structures

These are heavier architectural forms, which cannot be dismantled and moved in any way. There are examples where frame and cladding form a single body: thus, the walls are made of embedded poles that form the frame and the intervals between them are filled with any available material forming the cladding, such as: withies

¹¹ Guidoni 1987, 112-21, figs 196, 200-2; Nabokov and Easton 1989, 236-7, 250-2, 270-1 with ill.; Coucouzeli 1994, 334-40 with references, Appendix II: pls 10-12; Oliver 1997, 1801-2, 1814, 1817-8, 1823 with ill.

and mud, like in the round huts of the Lamba (Zambia) (where the frame also comprises an encircling veranda) (Fig. A1:12), wattle-and-daub and mud, like in the rectangular huts of the Kapu Soaras (Bihar, India)

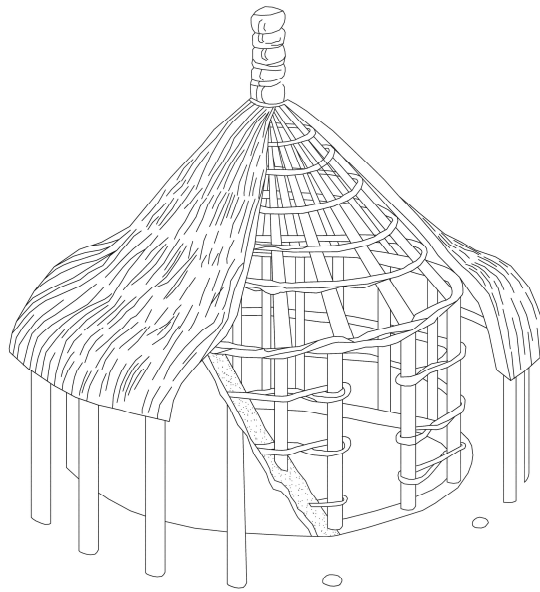


Fig. A1:12. Lamba hut (Zambia) (adapted from Oliver 1997, 2006).

(Oliver 1997, 940 with ill.), mudded straw, like in the rectangular huts of the Guarani (Brazil, Argentina) (Oliver 1997, 1693 with ill.), mud, like in the round huts of the Agnuak (Ethiopia) (where the frame also includes an encircling veranda) (Oliver 1997, 2017 with ill.), or stone, like in the rectangular huts of the Hill Soaras (Bihar, India) (Oliver 1997, 940 with ill.). In all these examples, the roof is pitched and covered with thatch, while the connections are made of vegetal lashings. But there are also examples where frame and cladding are independent of each other, such as the rectangular houses of the Dogon (Mali), which present an inner frame made of poles standing above ground (by resting either directly on the ground or on mud- or stone bases) and placed all along the non-load bearing walls, which are made of mud brick on a stone socle and form the cladding; the poles are forked to receive the beams of the flat roof (Guidoni 1987, 138 ff.; Oliver 1997, 2124); a similar construction is shown by the curvilinear houses of the Ashanti (Ghana), where the walls are made of ‘superimposed bands of clay’ (Guidoni 1987, 160, fig. 268).

III. Substantial timber-framed buildings, with external walls

These timber-framed buildings, all rectangular in plan, exhibit external walls that are non-load bearing and merely function as a protective envelope to an inner timber frame, which stands above ground and whose uprights, of squared or round cross-section, i.e. columns, rest upon stone bases, those constituting the perimeter of the frame being arranged close to, or half-engaged into, the walls. The uprights carry crossbeams supporting upper floor(s) and roof, sometimes forming part of a post-and-beam construction as part of a double-pitched roof. All the vertical and horizontal components of the frame are well fitted by means of carefully executed joints by specialized carpenters, while diagonal braces are often used to add rigidity to the frame. Among the examples are: the 19th century houses on Lefkada (Greece), known for their anti-seismic character, with squared posts along the external masonry walls of the ground floor (Fig. A1:13) (Vintzileou et al. 2007, with figs 8-9; Vintzileou 2011, 177, fig. 22); the Sherpa houses (Khumbu, Nepal), with squared posts

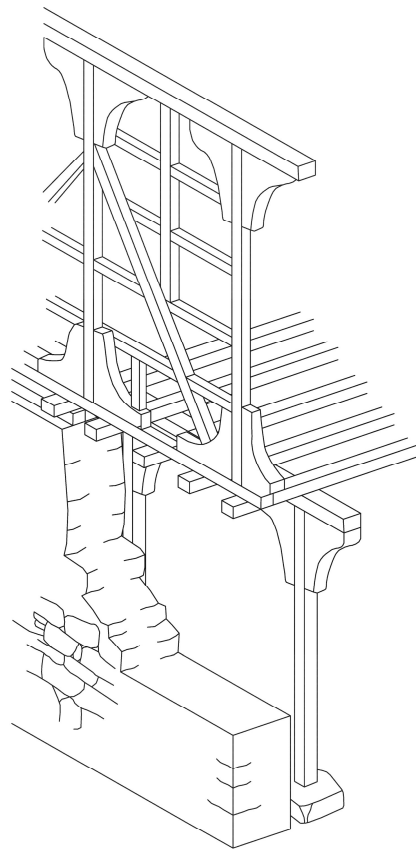


Fig. A1:13. The bearing system of the 19th century timber-framed houses in Lefkada (Greece)
(adapted from Vintzileou 2011, fig. 22c).

along the external walls, which are made entirely of stone (Sestini and Somigli 1978, 23, 61-3, figs 2, 14; Oliver 1997, 1037 with ill.); the Anhui houses (China) with wooden columns along the inner face of the external walls, which are made of bricks on a stone socle (Oliver 1997, 894-6 with ill.); the Bai houses (China) with wooden columns half-engaged in the external walls of adobe on a stone socle (Oliver 1997, 896 with ill.), the Tibetan house, with wooden columns along the external walls, which are made of adobe or rammed earth on a stone socle (Oliver 1997, 1041, 1043 with ill.; Wang et al. 2017 with ills., esp. fig. 2a); the traditional Vietnamese house, with wooden columns along the external walls, which are made of bricks, adobe, mud or rammed earth on a stone socle (Oliver 1997, 1047; Le 2006). In all these examples, the roof is pitched and covered with tiles (except for some Tibetan houses with a flat roof).

IV. Sophisticated timber-framed buildings

These are the timber-framed buildings characteristic of 12th-18th century northern- and central Europe (Figs A1:14 and A1:15) (Hansen 1971, 69 ff.; West 1971; Harris 1979; 1980; Brunskill 1987; 1994; Oliver 1997, 646-8; Zwerger 2015, *passim*). In Britain, they fall into three main categories: box-frame, aisled, and cruck buildings (Figs A1:4b1, A1:4b2, A1:4b3) (Harris 1979, 8-11). Focusing on the box-frame buildings, these are robust and technologically advanced, solidly assembled frame structures, made of a series of prefabricated frames (side-wall frames, cross-wall frames, floor frame, roof frame) of squared timbers (Harris 1979, 5, figs 1, 12), which are assembled on the ground and, when erected, are joined together to form the skeleton of a 'box', set upon a socle or a plinth of brick or stone, with or without the interposition of a wooden sill-beam, and therefore detached from the ground (Fig. A1:5a). The intervals between the posts form a series of square or vertical panels ('square framing' or 'vertical framing', the latter also known as 'close-studding')¹² (Fig.

¹² The square framing (panels about 3 feet square) was used in the past for buildings of lower social status or of lesser importance (cottages, barns etc.), whereas the vertical framing or 'close studding' – an impressive technique consisting of 'studs placed fairly close together', more rarely spaced as much as 2 feet (600 mm) or more – was used in buildings of high social status or public buildings, since 'it was expensive in timber and in carpenters' time' (Harris 1979, 23, 25, 61, 63, figs 17, 31; 1980, 27). It is

A1:15ab), which are infilled with various materials, such as wattle-and-daub, bricks, stone slabs, slates, laths, etc., depending on local availability (Fig. A1:16) (Harris 1979, 20-21), the infilled panels acting as cladding and forming, together with the posts, the walls. Thus, the timber frame and the cladding constitute here a single body. For the steep thatched or tiled roof, the 'post and truss construction' is used, where a series of

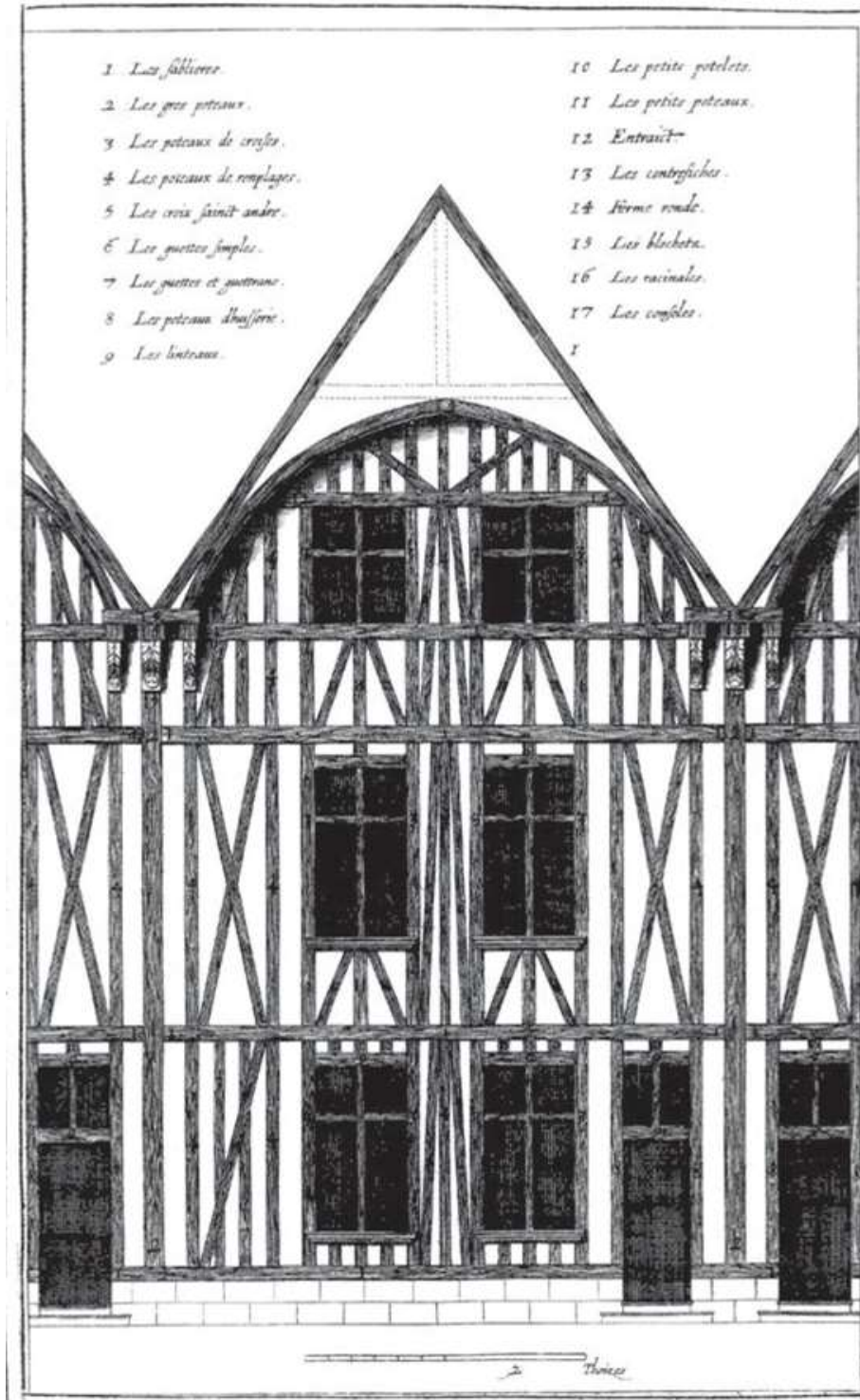


Fig. A1:14. Model of a timber-framed building in France (Source: Le Muet 1623, 101, reproduced in Journot 2013, fig. 3).

noteworthy that in timber-framed buildings with close studding, sometimes the sill-beam is not continuous but is interrupted by the main wall posts, which then 'rest on large foundation stones (stylobates) and the sill beams are tenoned into them rather than running beneath them' (Harris 1979, 80, fig. 41; Brunskill 1987, 56-7, fig. g).

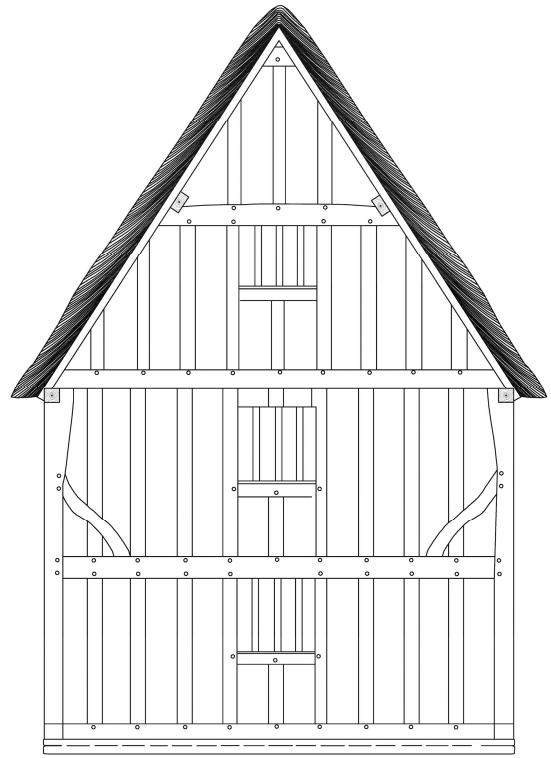
**a****b1****b2**

Fig. A1:15. British timber-framed buildings with (a) square panels in Cambridge, U.K. (photo by the author); and (b) vertical panels ('close-studding'): (b1) in East Anglia, mid-16th century (adapted from Harris 1979, fig. 31) and (b2) in Whittlesford, Cambridgeshire, early-16th century (photo courtesy of Gustavo Milstein ARB).

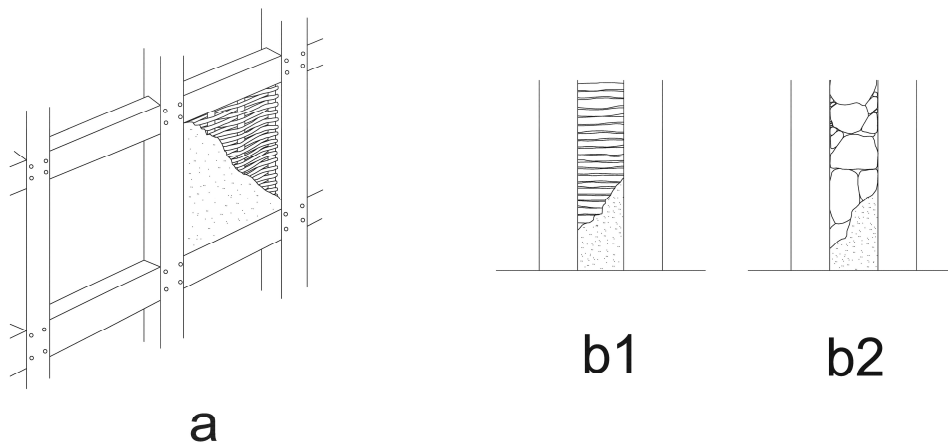


Fig. A1:16. Infill of (a) square and (b) vertical panels (close-studding) in British timber-frame buildings (adapted from Harris 1979, figs 15-16).

trusses¹³ are placed transversely across the building as part of the cross-wall frames, their tie-beams resting upon the main wall posts; in this way, the distribution of pressures and tensions operates in all directions (Fig. A1:3d). All the horizontal and vertical components of the frame are tied together using a variety of complex, sophisticated carved joints, the result of a high standard of craftsmanship, and they are also braced together by means of diagonal timbers (cf. Fig. A1:5b). In this way, a coherent, rigid, and strong, self-supporting box-frame is obtained, where all the framing members react jointly and homogeneously to the various loads, which are transmitted, through the joints, to the vertical uprights of the frame. In all these sophisticated timber-framed buildings, the roofs intended to be seen from the inside were of a very high architectural quality (Brunskill 1992, 93).

B.2. Archaeological examples

A great number of timber-framed buildings have been brought to light through archaeological excavations around the world. Let us first examine some examples from outside Greece, before we turn to examples from Greece itself, but also from Rome.

B.2.1. Archaeological examples from outside Greece

In North America, many examples of timber-framed houses belonging to native groups have been uncovered in various archaeological sites. For instance, the remains of Iroquois longhouses at the Howlett Hill site (Tuck 1967; Nabokov and Easton 1989, 78-9; Coucouzeli 1994, 327-8) or at the Nodwell Site, the latter also experimentally reconstructed (Ritchie and Funk 1973, with figs 28-9; Wright 1974, with pl. XX.1; Coucouzeli 1994, 326-9), suggest that the walls were framed with embedded poles, while two parallel rows of poles along the interior defined three aisles and would have supported both the roof and the saplings of sleeping bunks belonging to the bay-like compartments of the various families (as described by the ethnohistorical accounts).

In Europe, the best-known archaeological examples of timber-framed buildings are the Danubian Neolithic houses, both from the Bandkeramik (c.5600-4900 BCE) and post-Bandkeramik (c.4900-4400 BCE) cultures, which included longhouses reaching lengths of 43 m and 59 m, respectively (Soudský 1969; Coudart 1998, esp. 27, 31-2, 61-83, 200-1; 2013); these were rectangular (Bandkeramik) or trapezoidal (post-Bandkeramik) pole-framed structures, in their majority with a tripartite division into a front, a central (median) and a rear part, with earthfast uprights and a four-aisled interior, i.e. with three parallel rows of posts, one running along the long axis, to support the ridge beam, and two on each side, closer to the walls, to support the rafters, as well as posts along the sides of the house to support the eaves of the roof; the side posts were thinner, set in shallower pits (or in trenches) and arranged either in a single row or in a double row and sometimes in pairs, the outer row forming '(pseudo-)buttresses',¹⁴

¹³ For the truss, see *supra*, n. 9.

¹⁴ Coudart refers to this outer row of posts as '(pseudo-) contreforts' and explains them as supporting the ends of the rafters, i.e. the eaves of the roof, to provide protection to the walls, perhaps even for the storage of firewood (Coudart 1998, 31, 71, 83). However,

while they were interlaced with wattle coated with daub to form the protective screen of the walls;¹⁵ at the front of the house, a loft in the form of a high platform serving for the storing of cereals was supported by extra posts doubling the transversal posts of the timber structure so that one post supported the roof and another the granary (Fig. A1:17) (Coudart 1998, 72, 76, 104, fig. 83; 2013, 12, fig. 13); all the posts were probably forked or notched at the top to support the double-pitched, thatched roof, and held in place by vegetal lashings; the non-alignment of the five transversal posts indicates the absence of transversal linkage, i.e. of crossbeams, between the uprights of the frame, and the use of longitudinal linkage only,¹⁶ which is corroborated by the clay model of a Danubian Neolithic house from Střelice (Moravia) showing a timber-frame structure with axial posts supporting a ridge beam (post-and-ridge pole construction) without crossbeams (Fig. A1:18) (Palliardi 1916 cited in Coudart 1998, 62, fig. 49) and by ethnographic examples of pole-framed buildings with embedded posts and an axial line of posts supporting a ridge beam from Melanesia (Coudart 1998, 62, figs 59-61; cf. also Guidoni 1987, fig. 119);¹⁷ finally, at the rear of the house, a gablet roof, i.e. a roof with a small (triangular) gable, perhaps open, sitting at the top of a hipped roof, may have existed (Coudart 1998, 67, 69, 76, fig. 73).¹⁸

Other examples are: the Bronze Age longhouses of Northwestern Europe, which were rectangular or with one or two apsidal ends (some, incidentally, being exceptionally long, reaching 50 m-57 m and attributed to chiefs¹⁹), pole-framed, with embedded posts, and usually two- or three-aisled, i.e. with one or two rows of internal posts supporting the roof, while a row of posts (or sometimes a double row of thinner posts – Audouze and Büchsenschütz 1992, 59-60, 82, fig. 43.1) were set along the perimeter of the house to support the bottoms of the rafters at the eaves and form the skeleton of the walls, which were clad with wattle-and-daub (Harsema 1992, 78-80, fig. 6; Nielsen 1999, 161, fig. 10; Rasmussen 1999, 283-6, fig. 3; Fokkens 2003); in some cases, the internal roof-supporting posts that were closer to the walls were connected to the wall posts by means of wooden partitions, thereby subdividing the side aisles into a series of bays, which may have

I believe that such an arrangement could also have served to ensure the stability of the whole structure, like the veranda of the LK-T building (see Appendix 5).

¹⁵ In the longhouses, the two rows of posts in the interior that were closer to the walls perhaps also served for the attachment of perishable, wooden partitions stretching between them and the wall posts to delineate the space of each family unit along the side walls, an arrangement so characteristic of the ethnographically attested longhouses. Coudart writes that it is unlikely that every cross-row made of three central posts ('tierce') supported a screen, as 'it would have been especially inconvenient for the Bandkeramik people themselves' (Coudart 1998, 72). However, archaeological evidence from the Getman site (House 1) suggests that in the Iroquois longhouses, such screens did extend, in places, beyond the bunk lines of the family compartments, even across the central aisle to form partitions with a door in them (?) (for warmth or privacy) such as the 'inside doors' reported by H. van der Bogaert among the Iroquois (Coucouzeli 1994, 326 with references). Anyhow, nothing rules out the reconstruction of perishable partition walls or screens defining stall-like compartments and attached to the frame, like in the Iroquois longhouses and many other longhouses in the ethnographical record, where the family compartments can be partitioned off by means of planks, wattle, animal skins etc. (see Coucouzeli 1994, Appendix II: *passim*). In some European Bronze Age longhouses, there seems to be physical evidence for such partitions (see *infra*).

¹⁶ Soudský (1969, 11-12, fig. 2) pointed out the fact that in trying to include all the posts that are perpendicular to the long axis of the houses into an imaginary line of a width equal to that of a potential crossbeam, in no case was this possible, concluding that there was no transversal linkage in these houses but only longitudinal linkage. See also Buttler and Haberey 1936, pl. 34, no. 1; Soudský 1969, 11-12, fig. 2; Coudart 1998, 62, 76.

¹⁷ Soudský (1969, 15), followed by Coudart 1998, 62; 2013, 7) believe that some experimental reconstructions of these houses, which combine longitudinal and transversal linkage (the latter in the form of crossbeams attached to the central posts by means of lashings) are the result of a Western bias towards longitudinal linkage, the latter being 'deeply foreign' to Western thought (Coudart 1998, 62, figs 62-3; 2013, 7). Coudart writes that, in the absence of transversal linkage, the stability of the frame (i.e. its resistance to lateral wind forces) was achieved thanks to the elasticity of the connections and the materials, the mutual solidarity of the frame's components, the weight of the roof and the burying of the posts (Coudart 1998, 62, 71, 76); however, she does not emphasize the important role played here for the stability of the frame by the embedded posts, as is also demonstrated for the LK-T building (see Appendix 5).

¹⁸ This has been deduced from the fact that often the post holes of the rear wall are less deep: the weaker anchoring of the posts of the rear wall could be linked to the fact that they would have been submitted to a weaker vertical thrust due to a hipped roof (Coudart 1998, 67, 69, 76).

¹⁹ Nielsen 1999, 161, figs 10c (Eching, Bavaria, Germany: 53 m x 6 m), 10d (Straubing-Öberau, Germany: 57 m x 9 m), 11a (Gram, Jutland: 50 m x 10 m).

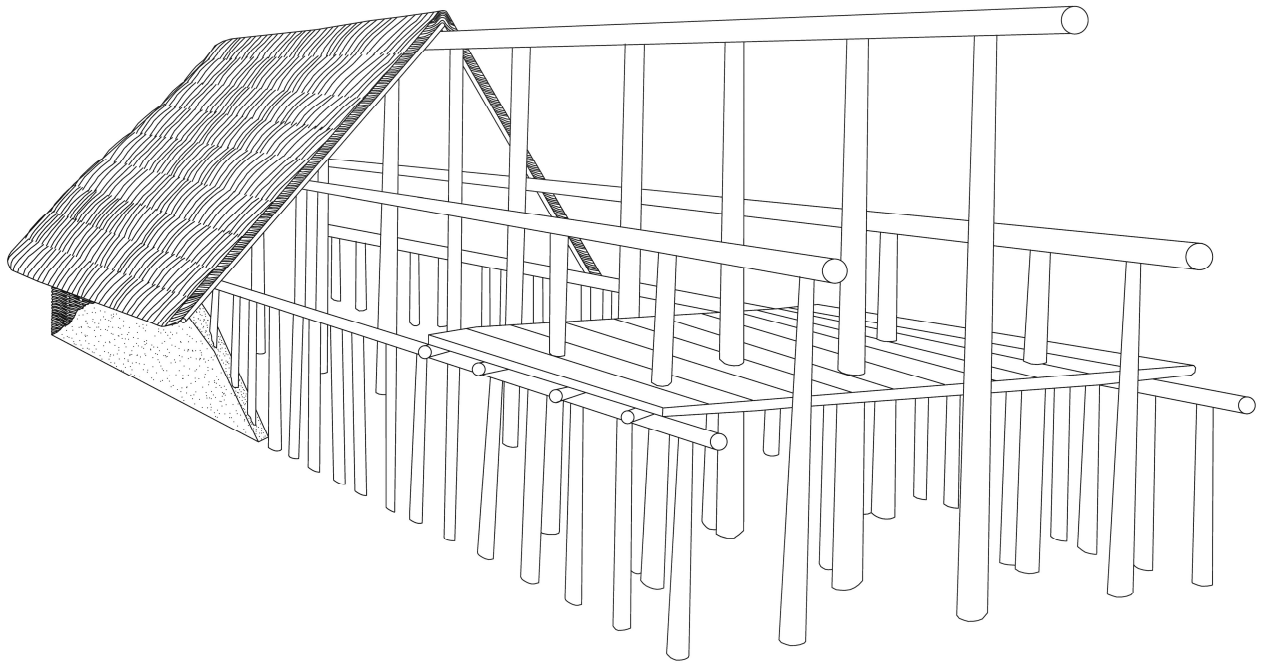


Fig. A1:17. Reconstruction of a Danubian Neolithic longhouse (adapted from Coudart 1998, fig. 83).

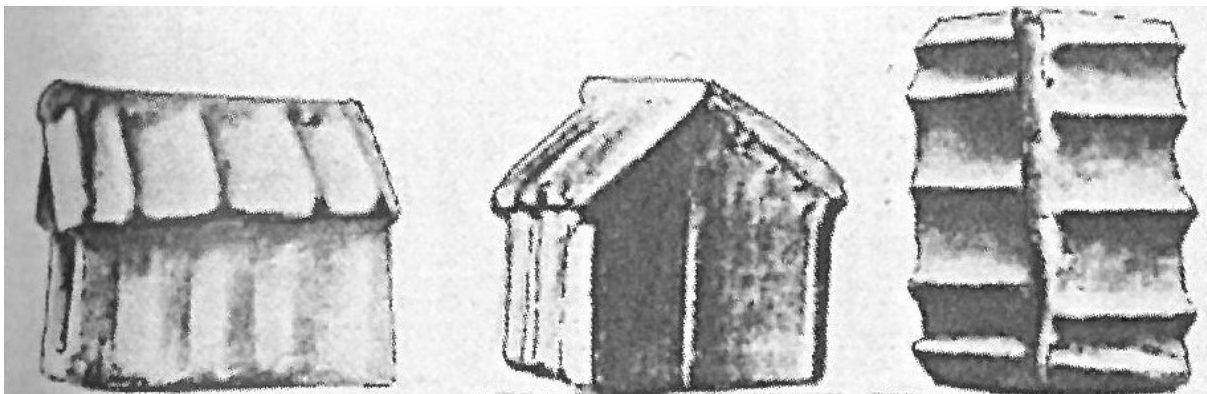


Fig. A1:18. Clay model of a Neolithic house from Střelice (Moravia) (Pallardi 1916, cited in Coudart 1998, 62, fig. 49).

served to separate the residential space of each nuclear family,²⁰ the Bronze Age longhouses in Hitzacker (Germany) (Lobisser 2018) and the Bronze Age and Celtic houses in Százhalombattai (Hungary) (Jerem et al. 2010), all of which have been experimentally reconstructed, or the apsidal longhouses in Guaya and Las Camas (Spain), dating to the Bronze Age/Iron Age transition (c. 1100-900 BCE) (Misiego et al. 2005; Urbina et al. 2007; Blanco-González 2011, 399, fig. 5): these examples present timber frames made of earthfast, round posts, of which those set on the long axis of the building supported the ridge beam and those set around the perimeter received the eaves of a thatched roof, while the cladding was made of wattle-and-daub; at Las

²⁰ Clear evidence of such partitions is provided by House 13 at Emmerhout and House 5 at Hijken (Drenthe, Netherlands) (Harsema 1992, 79-80, fig. 6), where they have been interpreted as byres for the stalling of cattle (as regards House 13 at Emmerhout with respect to this interpretation, see also: Waterbolk 1975, 386; Audouze and Büchschütz 1992, 132-4; Fokkens 1999, 36). One wonders, however, whether the bays in these particular longhouses were not actually family compartments defining the purely residential area; their central location within the longhouse, between a living room at the front and a storage area at the rear, placed symmetrically on either side of it (Harsema 1992, 80), is echoed in the longhouses of the native people in the Northeast part of North America, such as those of the Iroquois (Coucouzeli 1994, 320, Appendix II: pls 4:5, 4:6, 4:7, 4:8); a similar internal division into storage room-residential room-living room may have existed in the Lefkandi-Toumba building (Coucouzeli 1994, 24ff., 128 ff.).

Camas, the centre posts were buried deeper than the peripheral ones and all posts were packed inside their holes with adobe and wedged with stones and large pottery fragments.

B.2.2. Archaeological examples from Greece

B.2.2.1. Neolithic

In Greece, timber-framed buildings date back to the Neolithic period. These were all pole-frame structures, where frame and cladding formed a single body, with the posts along the line of the walls set in a single row (or, more rarely, in a double row). One distinguishes two types: the first type presents an elementary form, with the wall posts embedded in the ground and interlaced with wattle-and-daub that forms the cladding (e.g. Makri, Nea Makri, Elateia, Achilleion, Argissa); the second type is more solidly built, with the posts of the frame (sometimes interlaced with wattling) encased in the walls and the spaces between them filled with adobe (clay or mudbricks) resting either directly on the ground or on a stone socle and acting as cladding (e.g. Makri, Nea Makri, Nea Nikomedeia, Servia, Sitagroi).²¹

B.2.2.2. Minoan and Mycenaean

In Minoan and Mycenaean times, there were substantial timber-framed buildings, which used squared timbers and a three-dimensional (rather than a two-dimensional) framework, with posts standing above ground and a post-and-beam construction; they are sophisticated examples of anti-seismic solutions in frame construction. In the Minoan Neopalatial period, this type of construction appears quite generalized in Crete, its most elaborate and complete manifestation occurring in the palace of Knossos (Fig. A1:19), but it is also attested at Akrotiri (Thera), albeit in a limited number of walls (Xeste 2- north façade, Xeste 3- south façade) (Fig. A1:20), having been used as a very effective anti-seismic measure on this volcanic island. One is dealing with an elaborate and robust timber framework, a three-dimensional grid incorporated in the rubble masonry walls, which is made of posts set at regular intervals on both faces of the wall and resting (with or without the intermediary of a transverse timber) upon a dressed stone placed as a stretcher through the wall at a height of 0.20 m–1.00 m above the ground, as well as of beams running along the wall at the level of the door lintels, the window lintels and sills, the lintels of the clerestories of the pier-and-door partitions and the ceiling. Transverse beams set through the thickness of the masonry joined together the two faces of the grid. This timber framework also extended in the upper floors and constituted one of the main load-bearing components of the buildings, along with the (equally three-dimensional) timber frames of the pier-and-opening partitions, doors, and windows, as well as the timber columns, pillars and piers, and the ashlar masonry (Tsakanika-Theohari 2009; Palyvou 2005, 96, 120, 122-3, 181, 183-4, figs 63, 65, 132-3, 173; 2017, 255, 257-8; 2018, 61-5, 136-7, 140-1; Vintzileou 2011; Tsakanika 2017).²²

The timber frame construction technique was also a typical feature of Mycenaean architecture in the Greek mainland: it was applied extensively (in almost every wall) throughout the palatial complex at Pylos and it is also testified at Tiryns, Mycenae and Thebes.²³ It consisted, here too, of a three-dimensional timber grid made of vertical and horizontal members, which were encased in, and aligned with, each of the two faces of the rubble masonry walls (and of the mudbrick superstructure, where present), as well as of transverse

²¹ See Treuil 1983, 249, 253, 270-4, 282, 315, fig. 125; Renfrew 1986, 189-91, figs 8.9, 8.10, pls XXIII:1, XXVI-XXIX; Winn and Shimabuku 1989, 36-40, 46, figs 4.7, 4.8, 4.11, 4.12, 4.20, 4.26; Pantelidou-Gofa 1991, 192-5, figs 27, 43, 128; Perlès 2001, 180-3, 188-91, fig. 9.4; Souvatzi 2008, 64, 162-73, 183, figs 6.1, 6.13. About the Burnt House at Sitagroi, where some of the postholes forming part of the east wall 'appear to cut into the outside of the wall', i.e. into the outer face of the wall, the excavator writes: 'This clearly suggests that the wall structure ... was constructed ... after the erection of the timber frame of the house' (Renfrew 1986, 190-1).

²² The timber grid was not incorporated in the ashlar masonry walls. However, the ashlar masonry, when used in the interior of the buildings (rather than on the façade, where it is commonly used), seems to incorporate horizontal timbers, which appear to be structurally related to the timber grid of the rubble masonry walls (Tsakanika-Theohari 2009, 136-8; Tsakanika 2017, 280-1, 283).

²³ See Wace et al. 1921-1923, 87-90, fig. 20, pl. XIII d; Wace 1949, 55, 66-7, 95, figs 24a, 24b, 108b; Blegen 1965, 117-21 with references; Blegen and Rawson 1966, 36-8, 78-9 and *passim*, figs 22, 142; Küpper 1996, 67-94, figs 177-209, pls 34-45; Palyvou 2005, 181; *contra* Nelson (2017, 329-44), who theorizes, implausibly to my mind, that at Pylos a pier-construction was used instead of a timber-frame construction, and that the timber frame was used temporarily for the construction of what would have been in fact load-bearing, pier-walls (see *infra*, n. 25).

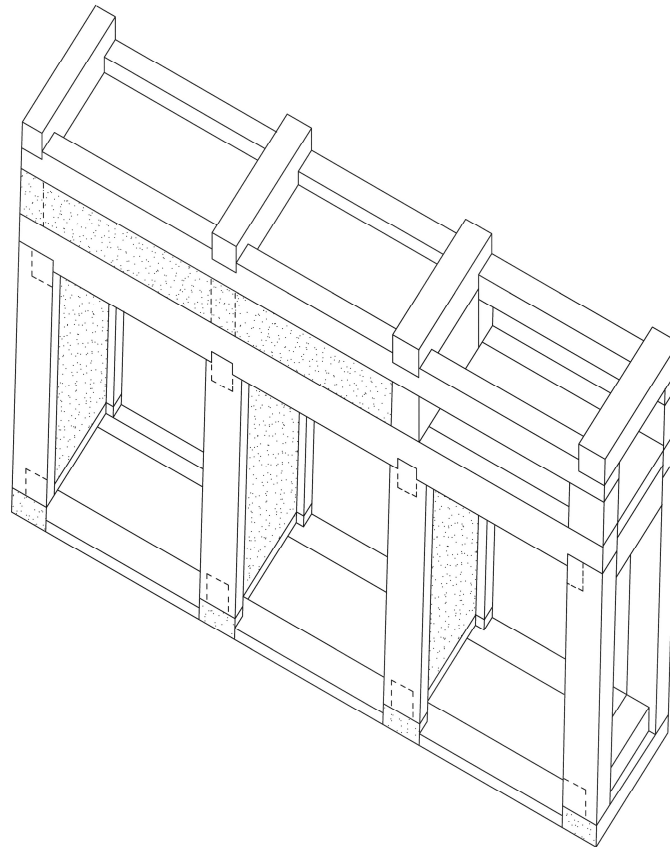


Fig. A1:20. Reconstruction of a wall of Xeste 3 at Akrotiri, Thera (adapted from Palyvou 2018, fig. 63).

members, which ran through the thickness of the wall and acted as cross-ties, tying together the timbers on each side.²⁴ The first beam from the bottom was placed either at floor level or higher up in the wall, at a height of *c.* 0.40-1.00 m. The posts were set at intervals of 0.55-0.90 m. In the Throne Room (Room 6) of the Palace at Pylos, most of the vertical posts of the frame had a plank-like cross-section (which also characterises the Lefkandi-Toumba building).²⁵

B.2.2.3. Early Iron Age and Archaic

In Early Iron Age and Archaic Greece, there is a fair number of examples of timber-framed structures, based either on a pole frame or on a square-timber frame.

Examples of pole-frame structures

Pole-frame structures, where the posts forming the sides of the frame were earthfast and independent of the non-load bearing walls, which were made of a stone socle with a superstructure of adobe (clay or mudbrick) and formed the cladding, are: the apsidal cult building ΣΤ at Mende-Poseidi (tenth century BCE) (Moschonissioti 1998 with fig. 10), the rectangular houses at Kastanas (tenth to ninth centuries BCE) (Hänsel 1989, 208 ff.) or the apsidal house IV-1 at Nichoria (*c.* 975 BCE) (McDonald et al. 1983, 19-42, figs 2-11, 2-21, 2-23), perhaps also the apsidal so-called ‘Daphnephoreion’ in the sanctuary of Apollo at Eretria (eighth

²⁴ Blegen, the excavator of the Palace at Pylos, did not recognize the load-bearing function of this timber framework, but rather attributed this function to the walls as part of what might be called a wall-centric or ‘toichocentric’ view; in his view, the role of the timber framework was to serve as reinforcement for the walls (Blegen 1965, 118).

²⁵ E.g. 0.14 m x 0.26 m (post in chase 38) or 0.11 m x 0.23 m (post in chase 36) (Nelson 2017, 330). Nelson has argued that the plank-like cross-section of these posts would have caused them ‘to buckle outward ... and eventually collapse’ under ‘any load placed on [them]’; thus, he concluded against any load-bearing function of such posts (compared to posts of a square cross-section, which he considers to be the only appropriate ones) and by extension of the timber frame as a whole, attributing such a function instead to the rubble masonry walls, which, according to him, can be reconstructed as pier-walls (Nelson 2017, 329-44). However, the plank-like cross-section of the posts may well have been intentional, to provide extra stability to the timber frame structure, as in the case of the wall- and veranda posts in the LK-T building (see Appendix 5).

century BCE),²⁶ in all of which the posts were set in pairs on either side (externally and internally) of the walls forming a three-dimensional frame (at Nichoria, the wall posts corresponded to axial posts resting on stone bases and all of them would have carried a thatched roof); or an oval house from Lefkandi-Xeropolis (Late Geometric), where the posts were set along the inner face of the wall (Popham and Sackett 1980, 14-15, 23-4).

Examples of square-timber frame structures

Examples where frame and cladding were independent of each other, with the posts at the perimeter of the frame placed along one side of walls made of a stone socle with an adobe (clay or mudbrick) superstructure or entirely of stone and acting as a mere protective envelope, are: the Lefkandi-Toumba building (c.950 BCE), the earliest Early Iron Age frame structure made of squared timbers, which were plank-like, embedded in post pits, where they left their clear imprint,²⁷ and placed at intervals between 0.80-2.35 m along the inner side of the stone-and-mudbrick exterior walls, as well as in the veranda (a precursor of the 'peristyle'), with a one-to-two correspondence between the wall- and veranda posts, on one hand, and round posts placed on the long axis of the building, on the other; the Archaic temple of Poseidon at Isthmia (first half of seventh century BCE), where a series of rectangular wooden posts,²⁸ were set at regular intervals against the outer face of the

²⁶ The excavators have reconstructed the so-called 'Daphnephoreion' at Eretria with posts standing above ground, upon circular 'clay bases', and the walls as comprising, above the stone socle, for reasons of religious symbolism, a screen of laurel foliage and branches (perhaps reinforced with *pisé*) (see Bérard 1971, esp. 67; Auberson and Schefold 1972, 118 f.; Auberson 1974, esp. 66). However, the 'clay bases' must represent the fill of pits dug for the wall posts, as very convincingly argued by Coulton (1988, 60-62; Popham et al. 1993, 58), with the clay acting as packing material for holding the embedded posts firmly into place; besides, the large diameter of the 'clay bases' (c.0.45-0.50 m) is more fitting to post pits than to post bases.

The excavators are of course right in arguing that the 'Daphnephoreion' was a timber-framed building and that the posts were set in place before the (non-loadbearing) walls. Thus, they write: 'une constatation fondamentale, d'ordre stratigraphique: les bases d'argile ont été fondées avant le mur, car elles sont toutes ... largement engagées sous les pierres qui le composent' (Bérard 1971, 64) and 'Les pierres des murs sont ... enfoncées dans la masse argileuse des bases; cette argile a même pénétré entre les pierres. Elle devait être encore fraîche lors de l'érection des murs' (Auberson 1974, 60). Bérard correctly concludes: 'Il appert donc que le mur est subordonné aux colonnes: ce sont elles qui jouent le rôle principal ...' (Bérard 1971, 64). However, Bérard reconstructs the sequence of erection of the building wrongly, when he writes: 'Le plan d'ensemble du monument a d'abord été tracé sur le sable, avec la situation de chaque colonne; puis on a posé les supports d'argile et de gravier pour celles-ci. Alors seulement le mur a été construit. Enfin on a dressé les piliers.' (Bérard 1971, 64); the correct building sequence will have been: 1. Tracing of the plan, including the position of the wall posts; 2. Setting of the 'clay bases' and the posts; 3. Erection of the walls.

As for the walls, it is more likely that their upper part was made of adobe, i.e. clay or mudbricks (cf. Drerup 1969, 14; Mazarakis-Ainian 1987, 11).

Drerup's hypothesis that the 'clay bases' and the existing stone socle belong to two distinct phases (first phase: 'clay bases' carrying pairs of posts between which rose light walls made of wattling, the posts having nothing to do with the walls but being designed to carry the roof, i.e. as part of a timber frame; second phase: an entirely new building at higher level, with a mass wall made of a stone socle and a mudbrick superstructure, the socle being designed to protect the mudbricks from rising damp, unlike a wicker wall) (Drerup 1986, esp. 13-14, *contra* Bérard 1971, 64; Auberson 1974, 60, who argue convincingly for a single phase) does not stand scrutiny (see Coulton 1988, 61; Schattner 1990, 132 n. 143).

All the elements of the timber frame have been hypothetically reconstructed by the excavators as made of poles, attached together by means of lashings, except for the door jambs, about which there is actual evidence that they were made of squared timbers (0.10 m x 0.42 m) (one wonders whether the wall posts were also squared timbers rather than poles); the jambs of the 3.50 wide door formed an integral part of the frame, as well as the 'lintel', which would have rested on the door jambs and would have been in fact a portion of the façade's crossbeam; the latter has been reconstructed by the excavators as made of two adjacent poles connected with the door jambs by means of lashings (Auberson 1974, 60-1, 65, fig. 2, pls 14-15). However, a tied connection between a square and a round timber would be quite unstable. In my opinion, the façade's cross beam should be reconstructed as made of a single, squared timber to allow a more secure connection with the squared timbers of the door jambs by means of carved joints; moreover, in timber-framing, 'one piece of timber is usually stronger than two joined together' (Sobon and Schroeder 1984, 40).

²⁷ The post pits were dug into the soft conglomerate rock of the site and backfilled with the excavated material, which was tightly compacted around the posts, thus allowing the imprint of the decayed timber to be preserved fairly clearly in the form of silvery grey dust (Coulton 1988, 59; Popham et al. 1993, 10-11, 38 and *passim*).

²⁸ Gebhard and Hemans 1992, 28, 30-1, fig. 8; Hemans 2015, 41-4. The wall posts are designated as 'piers' or 'pilasters' by the excavators because they believe, wrongly in my opinion, that they functioned as mere buttresses to the walls. The wooden 'piers' measured c.0.32 x 0.07-0.15 m; these dimensions are based on the sizes of the unburnt vertical bands that the 'piers' left on many of the wall blocks following the temple's destruction by fire (Broneer 1971, 26, 35; Gebhard and Hemans 1992, 28; Hemans 2015, 42-4). Before the discovery of the foundation pits of the 'piers' by Gebhard and Hemans (1992), the vertical bands that they left on the wall face were interpreted as the wooden frames of the painted stucco panels that decorated the exterior walls (following the

ashlar masonry walls, and embedded in the ground,²⁹ the latter feature clearly suggesting that they had a structural function, given also that their intervals were closely related to the spacing of the axial columns³⁰ and probably equal to the intervals of the columns in the peristyle;³¹ thus, the wooden wall-posts, together with the wooden columns of the interior and of the peristyle, would have supported a series of crossbeams that would have been dovetailed and notched into specially made ashlar blocks³² crowning the walls³³ and, ultimately, the hipped, tiled roof, in an architecture where the new, monumental use of stone in walls of ashlar masonry, even if still non-load bearing, is combined with the old building technique of timber-framing³⁴ –

interpretation by Broneer, the initial excavator (Broneer 1971, 35, 41, fig. 54; Rhodes 1984, 65-9, cited in Holmes 1995, 30; 1987, 478). Still now, after the discovery of the foundation pits of the wooden ‘piers’, the latter are interpreted likewise by some scholars (Holmes 1995, 26, 29-31; Barletta 2001, 166 n. 24, who also suggests that they were used for scaffolding).

²⁹ Rhodes (1984, fig. 23, cited in Holmes 1995, 30) followed by Holmes (1995, 31, fig. 7) have reconstructed these ‘piers’ as being slotted into stone blocks (Broneer’s ‘Group 7’ and ‘Group 8’ blocks). However, Rhodes’ study was based only on ‘Broneer’s findings’ (Broneer 1971, 3-53), before the discovery of the foundation pits for the wooden ‘piers’ during the new excavations conducted in the temple in 1989 (Gebhard and Hemans 1992, 25-40). The reconstruction of ‘piers’ standing above ground is unlikely, given that their foundation pits were of a substantial size (1.00-1.15 m x 0.55-0.65 m; depths unknown) (Gebhard and Hemans 1992, 28, where it is reported that the pits ‘vary in depth’).

³⁰ The intervals between the ‘piers’ were 2.26 m c/c (from centre to centre). The axial posts were embedded in round holes at intervals of c.4.52 m, i.e. twice the intervals between the ‘piers’, and also ‘positioned with respect to the mid-point between pairs of piers’ (Gebhard and Hemans 1992, 30).

³¹ Gebhard and Hemans 1992, 30, 34; Hemans 2015, 41 and fig. 3.15; see also Holmes 1995, 24 (*contra* those who maintain that the temple was non-peripteral – Rhodes 1984, 44-60; 1987, 477; Barletta 2001, 37-8, 49-51, 146). A peristyle must have existed also for the protection of the painted panels on the exterior walls from the weather.

³² In the axonometric reconstruction of the temple by the excavators (Gebhard 2001, fig. 1), a horizontal beam is shown joining the tops of the wooden ‘piers’ like a plate, on top of which lie the crossbeams that would have been dovetailed-and-notched into the specially made ‘transverse cutting-blocks’ (Broneer’s Group 6 blocks – Broneer 1971, 26-7) (see also Hemans 2015, fig. 3.15, restored cross-section of the temple). The excavators are right in assuming that the cuttings in these blocks, which are so reminiscent of carpentry joints, would have been used for crossbeams, since in timber-frame construction the dovetail lap joint is limited to situations ‘when great strength is needed to resist pull-out tendencies’ and has been used historically ‘as a tying joint on the bottoms of tie beams’ (Sobon and Schroeder 1984, 44-5), being ‘strongest when the grains of the two [jointed] timbers are at right angles to each other’ (Sobon and Schroeder 1984, 44; cf. Harris 1979, pls 22-3 showing ‘a lap-dovetail joint between tie-beam and wall plate’ in an English timber-framed building). In my opinion, the wooden ‘piers’ would have supported the crossbeams via a wooden plate joining their tops (such as is shown in Gebhard 2001, fig. 1, but with the difference that the plate would have been flush with the top of the walls – see *infra*). The position and height (0.164 m) of the plate are apparent from the unburnt horizontal band that it left on the side (height = 0.272 m) of a typical Group 6 block (e.g., Barletta 2001, fig. 22) between the dovetail cutting (depth = 0.058 m) and the dark band of damaged plaster in the block’s lower part (width = 0.05 m) (see also Rhodes 1984, fig. 23, reproduced in Holmes 1995, fig. 6: reconstruction of a part of the wall showing an undamaged vertical band at the centre, corresponding to a wooden ‘pier’, flanked on either side by the damaged plaster of the stuccoed panels and crowned by two Group 6 blocks – note, however, that Rhodes erroneously considers this as an interior wall and the ‘piers’ as standing on stone bases, since, as already mentioned, his study was undertaken before the discovery of the foundation pits for the ‘piers’). Apart from the evidence of the plate, the structural relationship between the wooden ‘piers’ and the crossbeams is further strengthened from the clear correlation that exists between the Group 6 blocks and the wooden ‘piers’: given that the length of a Group 6 block is equal to 0.76 m, the added length of three juxtaposed Group 6 blocks (2.28 m) is almost identical to the interval of 2.26 m between the ‘piers’ (from centre to centre), while three cross beams can be restored between each pair of ‘piers’ (Gebhard 2001, fig. 1).

By contrast, no structural relationship has been suggested by the excavators, Gebhard and Hemans, between the wall ‘piers’ and the crossbeams, even though they do appear to recognise the structural role of the ‘piers’ when they write that ‘both piers and columns were part of the same system (extending across the entire building) that supported the roof’, part of which were also ‘blocks showing the cuttings to support beams’, as they note (Gebhard and Hemans 1992, 31 with n. 85. Hemans clearly considers the walls of the temple as load bearing (Hemans 2015, 54-5) and, consequently, he argues that the walls were built prior to the wooden ‘piers’ (Hemans 2015, 44).

³³ In my opinion, these blocks would have formed part of the top course of the walls (cf. Holmes 1995, 29, 31, fig. 9, where however extra pieces of timber are notched into the cuttings to receive the cross beams, instead of directly ‘locking’ the latter into the notches). The geison blocks (Broneer’s Group 10 – Broneer 1971, 30-1) restored by Hemans on top of the walls instead (Hemans 2015, 54-5, fig. 3.15) – as it was done by Rhodes (1984, 82-5), because he himself rejected the idea of a peristyle – should, in my view, be reassigned to the entablature in the peristyle, where they were initially restored by Broneer (1971, 41, fig. 54), in connection with the bottoms of the rafters (see Klein 1998, 340).

³⁴ Rhodes has rightly pointed out that ‘the framework of wood employed in the Isthmia temple ... is reminiscent of the half-timbering system’, in an architecture where the use of stone was still ‘closely tied to the tradition of half-timbering’ (as shown by the use of notches and dovetails for the joining of wood and stone), and although he stated that the wooden ‘piers’ ‘appear in positions appropriate for half-timbering’ and suggested a connection between them and a timber plate running along the top of the ashlar masonry wall, he also stated that, ‘[u]nlike in the case of half-timbering ... the function of [the wooden ‘piers’] was, at least in part, decorative’, i.e. ‘they framed painted panels’ (Rhodes 1987, 478; see also Holmes 1995, 30). However, as noted above, Rhodes’

naturally, since we are here at a very early stage in the development of monumental, stone architecture and any experimentation will have been treated with caution;³⁵ the temples at Kalapodi, Nikoleika (Helike) and Halieis, where the wall posts stood above ground, upon stone bases, suggesting a technologically more advanced timber frame structure, with special arrangements to ensure its stability (*supra*): in the apsidal South Temple 6 at Kalapodi (Late Geometric-early Archaic), during all three phases of the temple, the wall posts forming part of the frame stood directly in front of the inner face of the wall, which was made of a stone socle with a mudbrick superstructure; in the first phase, the wall posts were embedded in post-holes, but in the second phase they already stood upon stone bases; in the third phase (second half of seventh century BCE), the wall posts, set at intervals of 1.96-2.75 m, appear to have had a half-octagonal cross-section (precursors of the fluted column?), as they rested upon rectangular stone bases that were half-octagonal and faceted in their part above ground; a row of octagonal posts resting on rectangular stone bases with a raised, octagonal central part, would have existed on the longitudinal axis of the building; wall posts and centre posts would have supported crossbeams (in a post-and-beam construction) and, ultimately, a double-pitched, thatched roof;³⁶ in the apsidal temple of Poseidon (?) at Nikoleika (Helike) (end of eighth century BCE) (Kolia 2011, 206-7, 228-31, figs 4-9, 45-6), the framing posts rested upon rectangular stone bases running along the inner side of the wall,³⁷ at intervals of 1.80 m-2.0 m, and have been reconstructed accordingly with a rectangular cross-section;³⁸ on the long axis of the building, a row of wooden columns stood on stone bases, at intervals roughly corresponding to those of the wall posts; both the wall posts and the ‘central colonnade’ would have supported a thatched, pitched roof;³⁹ in the Early Archaic temple of Apollo at Halieis (seventh century BCE) (Jameson 1973; 1974; Bergquist 1990 with fig. 3), the wall posts, in the form of half-columns, stood upon semi-circular, apparently faceted stone bases (Hellner 2013, 50) set, at 1.50 m intervals, on a narrow ledge projecting from the lowest course of stones of the walls (Jameson 1974, 116), which may have consisted either of a stone socle surmounted by mudbricks (Jameson 1973, 364; Holmes 1995, 47) or entirely of stone (Jameson 1974, 116);⁴⁰ a row of wooden columns ran along the central axis (in at least the two rear rooms) of the building, resting upon square stone bases topped by circular plinths, and both the ‘engaged’ and the axial columns supported a tiled roof; another example is the Archaic second temple of Hera (or Hekatompedon II) on Samos (mid-seventh century BCE),⁴¹ where the wall posts of the timber frame were set along the inner side of the stone walls, resting on a continuous base of stone slabs that formed a kind of low bench, with a one-to-one correspondence to the wooden posts in the peristyle, which stood on round stone bases;⁴² all these posts, which had a roughly square cross-section, would have supported, via a post-and-beam construction, the weight

study preceded the discovery of the foundation pits for the wooden ‘piers’, a discovery that reinforces the view of the temple as a ‘half-timbered’, i.e. timber-framed building on the way to transition towards a building with load-bearing stone walls.

³⁵ Cf. Vitruvius’ remarks in his analysis of the origin and invention of the Greek orders: *in aedificiis omnibus insuper conlocatur materiatio* (Transl.) *In all buildings [i.e. temples] the timber framed work ... crowns them* (*De architectura* 4.2.1) and *a materiatura fabrilis in lapideis et marmoreis aedium sacrarum aedificationibus artifices dispositiones eorum sculpturis sunt imitati et eas inventiones persequendas putaverunt* (Transl.) *following the arrangement of timber framing, workmen have imitated, both in stone and marble, the disposition of timbers in sacred edifices* (*De architectura* 4.2.2).

³⁶ Touchais 1983, 777; Felsch et al. 1987, 14-5; Hellner 2013, 47-50, figs 3-5; Hellner 2014, 295-7, figs 6-8. Felsch incorrectly assumes that the wall posts served, in addition to supporting the roof, to buttress or strengthen the walls. Cf. Hellner in a comment on the architecture of the early Greek temples, which was prompted by the South Temple 6 at Kalapodi (Hellner 2013, 47).

³⁷ The excavator describes the posts of the wall as ‘piers’ intended to act as internal buttresses or reinforcements for the walls to help them support the roof (Kolia 2011, 207, 230), following a wall-centric view (*supra*, n. 24).

³⁸ Hellner (2013, 49) is wrong in assuming posts of a round cross-section here.

³⁹ The reconstruction of the temple by Kolia (2011, fig. 46) shows only a longitudinal linkage between the posts, without any transversal linkage (i.e. crossbeams); however, the latter is indispensable here, since the posts stand above ground.

⁴⁰ Jameson (1974, 116) and Bergquist (1990, 25) incorrectly assume that the role of the wall posts was to reinforce load-bearing walls.

⁴¹ I follow the prevailing interpretation of the eighth and seventh century BCE remains of the Samian Heraion as representing two different temples, Hekatompedon I and II, rather than a single Hekatompedon with two building phases (a view originally advocated by Mallwitz 1981, 624-33), on grounds which are expounded in Coucouzeli 1994, 179 n. 41.

⁴² Placing the posts above ground would have been a perfect solution here, since the site was subject to floods, such as the flood that c. 670 BCE destroyed the predecessor of this temple, Hekatompedon I (eighth century BCE). Incidentally, the first temple of Hera or Hekatompedon I appears to have also been a timber-framed building but with the framing posts probably incorporated in the stone- and mudbrick walls and supporting, together with a row of axial posts, a thatched roof (see Berve and Gruben 1963, 449, where the temple is identified as a timber-framed building, although it is wrongly assumed that the posts of the wooden frame had the role of strengthening the walls and supporting the roof in conjunction with the latter, since in a frame construction, the walls are not load-bearing).

of a hipped roof, which must have also been carpentered with squared timbers; two more, free-standing wooden posts, aligned with the easternmost pair of wall posts, would have framed the 5.50 m wide entrance.⁴³

Examples where frame and cladding formed a single body, with the wall posts incorporated within the walls, are: the Archaic temple of Artemis Orthia at Sparta (early seventh century BCE), where rectangular, plank-like posts would have been encased within specially made stone-cladded sockets, at intervals of *c.* 1.25 m, within the stone socle of the (non-load bearing) walls which, for the rest, were filled with adobe (mudbricks or clay); to the wall posts would have corresponded a row of timbers standing upon stone slabs, at similar intervals, on the long axis of the building; the exact, one-to-one correspondence between wall posts and axial posts clearly suggests that they were all designed to jointly support the roof as part of a timber frame.⁴⁴ One must also mention as examples two terracotta models of houses: first, the model from the Heraion at Argos (seventh century BCE)⁴⁵ (Fig. A1:21) (Schattner 1990, 22-26 with further references, fig. 1.2, pl. 1), whose painted decoration on the walls represents, in my view, ‘vertical’ framing (also known as ‘close studding’) (*supra*, Box-frame buildings), with a series of squared timber posts or rather studs standing close to each other

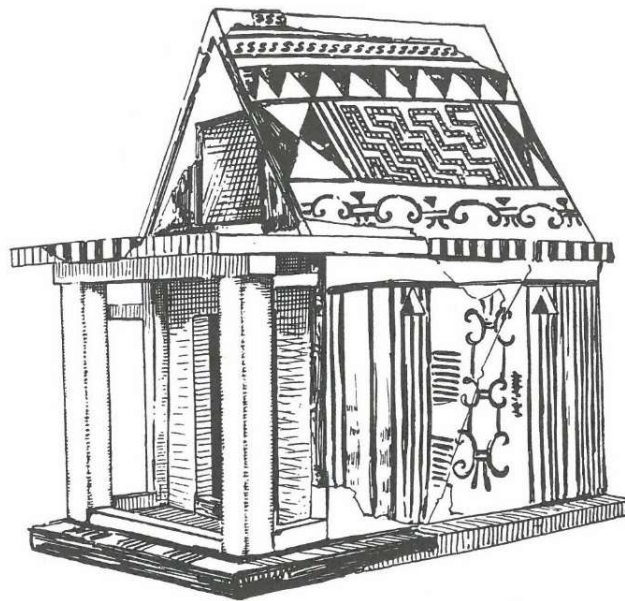


Fig. A1:21. Clay model of a building from the Heraion at Argos, seventh century BCE (Oikonomos 1931, fig. 15).

(vertical lines) between a wooden sill at the bottom and a wooden plate at the top (horizontal lines),⁴⁶ and with long and narrow panels filled with laths (short horizontal lines), coated with plaster (cf. Fig. A1:16*b*) and

⁴³ This is the generally accepted view about the structure of this temple; see Buschor 1930, 157, figs 5-6, 16; Berve and Gruben 1963, 449-51, figs 117-8; Dinsmoor 1950, 48; Lawrence 1957, 92-3; Tomlinson 1976, 124-5; Walter 1990, 82. The existence of a timber frame in this temple is also strongly suggested by the close spacing (2.20 m) of the peristyle posts and their roughly square cross-section (0.27 m-0.29 m x 0.35 m-0.36 m – Buschor 1930, fig. 14), which has been described as ‘the extremely simple practical [form] used even today by any carpenter’ (Berve and Gruben 1963, 450).

⁴⁴ Dawkins 1907/8, 17 ff., figs 5-7, pl. 1; 1929: 9-12, figs 5-8, plans I, IIB; Drerup 1969, 19-21, fig. 16; Catling 1994, 272-3. The rectangular shape of the timber posts is inferred from the shape of the stone slabs on which they would have rested, which measured *c.* 0.40 x 0.10 m. The same timber-framing technique characterized Megaron 3 at Gordion (eighth century BCE), with wall posts standing in niches 0.45-0.50 x 0.20 m within walls that were built of stone to a considerable height (Young 1960, 237, fig. 16). *Contra* Coulton, who assigned to the wall posts of the temple of Artemis Orthia at Sparta the function of anchoring the roof indirectly to the ground by being fixed to a wall plate running on top of load-bearing walls (Coulton 1988, 63).

⁴⁵ Several scholars have interpreted the painted vertical and horizontal lines on the Argos model as representing timbers having a structural character (see, for instance, Drerup 1969, 70-71; Bérard 1971, 66; Gruben 1976, 30).

⁴⁶ Close-studding is a distinguishing feature of timber-framed buildings in East Anglia, where the maximum spacing of the studs is 0.60 m (Harris 1979, 23, 61, 80, figs 17, 29, 31, 41). This answers Schattner’s objection that the vertical lines are too closely set to be attributable to timber-frame construction (*Fachwerk*) (Schattner 1990, 136). Schattner also points out here Brockmann’s objection (Brockmann 1968, 21) that the lines in question do not take into consideration the small triangular windows in the upper part of the walls (Schattner 1990, 136); in fact, however, in close studded timber-framed buildings, the series of studs can be interrupted by windows (e.g. Harris 1979, fig. 31). It must be pointed out that Schattner (1990, 131-2 with n. 143) distinguishes erroneously between *Fachwerk* (timber-frame construction) and what he calls *Mischbauweise* (mixed construction), with the former

painted over with ornamental motifs (cf. Zwerger 2015, fig. 381) – it actually looks as if the finished coat has been applied only to certain panels or that it has fallen off in places, leaving the laths exposed, as it can indeed occur in northern European timber-framed buildings (e.g., Harris 1979, pls 3, 24);⁴⁷ the plates of the wall-posts would have supported crossbeams for the upper floor (series of alternating black and white rectangles at the edge of the roof) and the rafters of the roof, which was high-pitched, probably plastered over with clay⁴⁸ and painted with ornamental motifs (as is also the case in many ethnographic examples); second, the model from the temple of Artemis Orthia at Sparta (seventh or early sixth century BCE) (Catling 1994, with figs 1-3) (Fig. A1:22a): the painted wall decoration suggests a timber-framed building, where frame and cladding

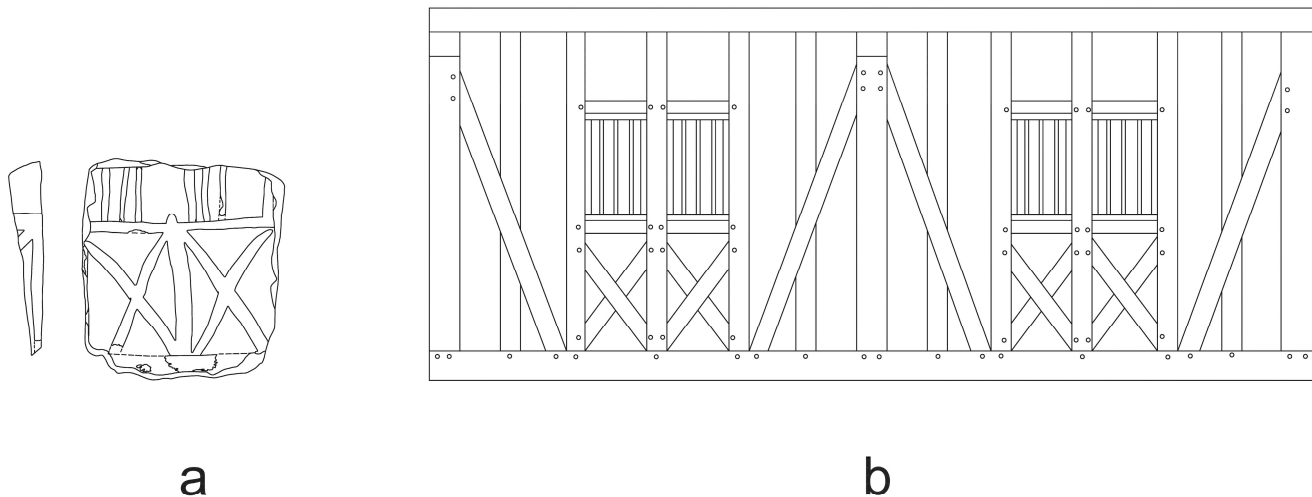


Fig. A1:22. (a) Fragment from the clay model of a building from Sparta, seventh or early sixth century BCE (adapted from Catling 1994, fig. 3); (b) Timber-framed building in Provins (France) with square panels containing braces in the form of St Andrew's crosses and mullion windows above, 15th century (adapted from Deforge 2013, fig. 3).

form a single body, like in the case of the Argos model, but unlike in the latter, use is made of large, rectangular wall panels, which are cross-braced with double diagonal braces (two juxtaposed rectangles with crossed diagonals and the beginning of a third) reminiscent of the square panels with St Andrew's crosses in several northern European timber-framed buildings (*supra*) (Fig. A1:22b) (cf. Alix and Épauld 2013, *passim*; Zwerger 2015, fig. 136); above the panels and under a plate at the top of the walls (horizontal band of paint at the top), there appear to be windows made of three mullions each (two sets of three vertical paint-strokes and the beginning of a third), like in old northern European timber-framed buildings (Fig. A1:22b) (cf. West 1971, 67-68, fig. 20; Harris 1979, 25, figs 17-18, 29, 31, 41, pls 8, 24 showing (un glazed) mullion windows in English timber-framed buildings; Deforge 2013, 102, fig. 3); the wall posts that form part of the panels rest on a wooden sill beam or directly on a low stone socle (broad, horizontal band of paint beneath the two juxtaposed rectangles).

term meaning only those timber-framed buildings where the posts are integrated in the thickness of the wall, like in northern European timber-framed (or 'box-framed') buildings, and the latter term meaning a construction where the posts are detached from the (non-loadbearing) solid wall by being placed on one or both sides of the wall. In fact, both types are timber-framed buildings.

⁴⁷ *Contra* Schattner (1990, 136-7, 139), who argues that, even though timber-frame (*Fachwerk*) components are clearly represented on the model, these were probably simply painted on the plaster applied on solid walls; in a similar line of thought, Barletta (2001, 42) wonders whether the painted decoration of the model's walls are just 'decorative elements'.

⁴⁸ Cf. Vitruvius, *De Architectura*, 2.1.3: *fastigia facientes luto inducto, proclinatis tectis stillicidia deducebant*. (Transl.) *they made their roofs of two inclined planes meeting each other in a ridge at the summit, the whole of which they covered with clay, and thus carried off the rain.*

B.2.3. Archaeological examples from Rome

Vitruvius describes the earliest timber-frame structures thus: *primumque furcis erectis et virgulis interpositis luto parietes texerunt.* (Transl.) *At first they set up forked stakes connected by twigs and covered these walls with mud.* (*De Architectura*, 2.1.3, transl. M. H. Morgan, 1914).

This clearly suggests a construction, where the frame and the cladding form a single body, the former made of poles and the latter of wattle intertwined with the poles and covered with daub ('wattle-and-daub' technique). This pole-frame construction is well exemplified by the remains of oval huts found on the Palatine Hill in Rome (eighth century BCE), which consisted of walls framed by unhewn, deeply buried poles and covered with screens made of wattle-and-daub; together with a central pole, the side poles would have supported a pitched roof most likely of the prop-and-ridgepole type, without any crossbeams, with all the frame elements being tied together by means of lashings (Puglisi 1951; Ulrich 2007, 91-96, fig. 6.1).

As regards the square-timber framing technique, this was popular in Roman times and many examples survive in Pompeii and Herculaneum (Oliver 1997, 647). Here, one is dealing with buildings, where the timber frame and the protective envelope form a single body, much like in the 12th-18th century northern and central European timber-frame buildings mentioned above. The best-preserved and most complete example is the 'Casa a Graticcio' or 'House of Wattlework' in Herculaneum (Maiuri 1958, 407-20, pl. XXXV; Hansen 1971, 18; Oliver 1997, 647; Ulrich 2007, 99; Wallace-Hadrill 2011, 261-5, 346; Stellacci and Rato 2019). This house was so named by Maiuri, its excavator, on the basis of Vitruvius' reference to [*parietes*] *craticii* or walls made of wattle (*cratis*) and plastered ('wattle-and-daub' technique) as part of a timber frame made of upright elements or *arrectaria* and horizontal members or *transversaria*.⁴⁹ In this passage, Vitruvius points out the disadvantages of wattled walls and laments their invention, since despite being expedient and economic, saving in time, money, as well as space (when used for thin, internal partitions), they are highly inflammable, susceptible to moisture, and their plaster is subject to cracking (at the interface between the timber framework and the panels' infill), unlike brick walls; he recommends that such walls be made to stand on a foundation raised from the ground, rather than placed below ground, so as not to rot, settle, or bend forward. In the Casa a Graticcio, the timber frame, which is used in the thin walls serving as partitions or forming the external walls of the balcony that projected over the street, is made of squared posts (*arrectaria*), which occupied the whole height of the wall, and horizontal components (*transversaria*), which formed square panels, with an infill of rubble masonry,⁵⁰ without any diagonal bracing members.

⁴⁹ Vitruvius, *De Architectura* 2.8.20: *craticii vero velim quidem ne inventi essent. quantum enim cleritate et loci laxamento prosunt, tanto maiori et communi sunt calamitati, quod ad incendia uti faces sunt parati. itaque satius esse videtur impensa testaceorum in cumptu quem compendio craticiorum esse in periculo. etiamque in tectoriis operibus rimas intus faciunt arrectariorum et transversariorum dispositione. cum enim linuntur, recipientes umorem turgescunt, deinde siccescendo contrahuntur et ita extenuati dirumpunt tectoriorum soliditatem. sed quoniam nonnullos celeritas aut inopia aut in pendenti loco dissaepitio cogit, sic erit faciendum. solum substruatur alte, ut sint intacti ab rudere et pavimento. obruti enim in his cum sunt, vetustate marcidii fiunt, deinde subsidientia proclinantur et dirumpunt speciem tectoriorum.*

(Transl.) *As for "wattle and daub" I could wish that it had never been invented. The more it saves in time and gains in space, the greater and the more general is the disaster that it may cause; for it is made to catch fire, like torches. It seems better, therefore, to spend on walls of burnt brick, and be at expense, than to save with "wattle and daub," and be in danger. And, in the stucco covering, too, it makes cracks from the inside by the arrangement of its studs and girts. For these swell with moisture as they are daubed, and then contract as they dry, and, by their shrinking, cause the solid stucco to split. But since some are obliged to use it either to save time or money, or for partitions on an unsupported span, the proper method of construction is as follows. Give it a high foundation so that it may nowhere come in contact with the broken stone-work composing the floor; for if it is sunk in this, it rots in course of time, then settles and sags forward, and so breaks through the surface of the stucco covering.* (transl. M. H. Morgan, 1914).

⁵⁰ The fact that the infill of the panels is everywhere made of rubble masonry, except in one case where it is made of wattle or rather of interlaced slats of reeds, which, in Maiuri's words, 'is the true and proper *opus craticium*' (Maiuri 1958, 410, 414), makes Maiuri's reference to the *opus craticium*, and by extension his naming of the 'Casa a Graticcio', a bit imprecise. A more accurate term, in my opinion, would be *contignatio*, a term that is in fact used by Vitruvius towards the end of the above-mentioned passage (*De Architectura*, 2.8.20) to mean 'timber-framing' (*de contignationibus autem et copiis earum, quibus comparentur ut ad vetustatem non sint infirmae, uti natura rerum monstrat explicabo.*) (Transl.) *I shall now proceed to the use of timber in framing, and to a description of its several sorts, as also of the mode of fitting timbers together, so that they may be as durable as their nature will permit.* (transl. by J. Gwilt, 1826) or *Next, following the guidance of Nature, I shall treat of the frame-work and the kinds of wood used in it, showing how they may be procured of a sort that will not give way as time goes on.* (transl. by M. H. Morgan, 1914) as well as elsewhere (*De Architectura*, 2.9.6: *et primum abies ... rigore naturali contenta non cito flectitur ab onere, sed directa permanet in contignatione.*) (Transl.) *First, the fir, ... bound together by its natural hardness it does not easily bend, but keeps its shape in framing* (transl. by J. Gwilt, 1826) or *To begin with fir ... its consistence being naturally stiff, it does not easily bend under the load, and keeps its straightness when used in the framework.* (transl. by M. H. Morgan, 1914). The noun *contignatio* comes from

REFERENCES

- Acland, J.H. 1972. *Medieval Structure: The Gothic Vault* (Toronto).
- Alix, C. and Épaud, F. (eds), 2013. *La construction en pan de bois au Moyen Âge et à la Renaissance* (Tours and Rennes).
- Auberson, P. 1974. 'La reconstitution du Daphnéphoreion d'Érétrie', *Antike Kunst* 17, 60-8.
- Auberson, P. and Schefold, K. 1972. *Führer durch Eretria* (Bern).
- Audouze, F. and Büchsenschütz, O. 1992. *Towns, Villages and Countryside of Celtic Europe. From the beginning of the second millennium to the end of the first century BC*, transl. by H. Cleere (London).
- Barletta, B.A. 2001. *The Origins of the Greek Architectural Orders* (Cambridge).
- Béa, A. 2013. 'L'architecture civile en pan de bois à Labruguière, à Sorèze et dans le sud du Tarn deuxième moitié du XV^e-XVI^e siècle', in C. Alix and F. Épaud (eds), *La construction en pan de bois au Moyen Âge et à la Renaissance* (Tours and Rennes), 395-415.
- Bérard, C. 1969. 'Note sur la fouille au Sud de l'Hérôon', *Antike Kunst* 12, 74-9.
- Bérard, C. 1970. *Eretria III. L'Hérôon à la Porte de l'Ouest* (Berne).
- Bérard, C. 1971. 'Architecture érétrienne et mythologie delphique', *Antike Kunst* 14, 59-73.
- Bergquist, B. 1990. 'Primary or Secondary Temple Function: The Case of Halieis', *OpAth* 18, 23-37.
- Berve, H. and Gruben, G. 1963. *Greek Temples, Theatres and Shrines* (London).
- Blanco-González, A. 2011. 'From huts to the 'house': the shift in perceiving home between the Bronze Age and the Early Iron Age in central Iberia (Spain)', *Oxford Journal of Archaeology* 30, 393-410.
- Blegen, C.W. 1965. 'Architectural Notes from Pylos' in *Χαριστήριον εις Αναστάσιον Κ. Ορλάνδον* (Athens), 117-25.
- Blegen, C.W. and Rawson, M. 1966. *The Palace of Nestor at Pylos in Western Messenia* (Princeton, N. J.).
- Brockmann, A. 1968. *Die griechische Ante: Eine typologische Untersuchung* (Marburg).
- Broneer, O. 1971. *Isthmia I: The Temple of Poseidon* (Princeton, N. J.).
- Brunskill, R.W. 1987. *Illustrated Handbook of Vernacular Architecture*, 3rd edn (London).
- Brunskill, R.W. 1992. *Traditional Buildings of Britain: An Introduction to Vernacular Architecture*, 2nd edn (London).
- Brunskill, R.W. 1994. *Timber Building in Britain*, 2nd edn (London).
- Buschor, E. 1930. 'Heraion von Samos: Frühe Bauten', *Mitteilungen des Deutschen Archäologischen Instituts in Athen* 55, 1-99.
- Buschor, E. and Schleif, H. 1933. 'Heraion von Samos: Der Altarplatz der Frühzeit', *Mitteilungen des Deutschen Archäologischen Instituts in Athen* 58, 146-73.
- Buttler, W. and Haberey, W. 1936. *Die bandkeramische Ansiedlung bei Köln-Lindenthal* (Berlin and Leipzig).
- Catling, R.W.V. 1994. 'A fragment of an archaic temple model from Artemis Orthia, Sparta', *BSA* 89, 269-75.
- Chatzēmichalē, A. 1957. *Sarakatsanoi* (Athens).
- Coucouzeli, A. 1994. *The Lefkandi Toumba Building and Social Organisation in Early Iron Age Greece* (unpublished PhD thesis, University of Cambridge).
- Coucouzeli, A. 1999. 'Architecture, Power and Ideology in Dark Age Greece: A New Interpretation of the Lefkandi Toumba Building', in R. F. Docter and E. M. Moormann (eds), *Proceedings of the XVth International Congress of Classical Archaeology, Amsterdam, July 12-17, 1998* (Amsterdam), 126-9.
- Coucouzeli, A. 2004. 'From Tribe to State in Early Iron Age Greece: The Archaeological Evidence from Lefkandi and Zagora', in N. Stambolidis and A. Giannikouri (eds), *Proceedings of the International Symposium "The Aegean in the Early Iron Age", Rhodes 1-4 November 2002* (Athens), 461-80.
- Coudart, A. 1998. *Architecture et société néolithique. L'unité et la variance de la maison danubienne* (Paris).
- Coudart, A. 2013. 'The Reconstruction of the Danubian Neolithic House and the Scientific Importance of Architectural Studies', *EXARC Journal Issue 2013/3* (available online <<https://exarc.net/issue-2013-3>> accessed March 2022).
- Coulton, J.J. 1988. 'Post Holes and Post Bases in Early Greek Architecture', *Mediterranean Archaeology* 1, 58-65.
- Dawkins, R.M. 1907/8. 'The Sanctuary of Artemis Orthia', *BSA* 14, 4-29.
- Dawkins, R.M. 1929. *The Sanctuary of Artemis Orthia at Sparta* (London).
- Deforge, O. 2013. 'Le bois dans l'architecture civile à Provins XII^e-XVII^e siècle', in C. Alix and F. Épaud (eds), *La construction en pan de bois au Moyen Âge et à la Renaissance* (Tours and Rennes), 99-109.
- Dinsmoor, W.B. 1950. *The Architecture of Ancient Greece* (London).
- Drerup, H. 1986. 'Das sogenannte Daphéphoreion in Eretria', in K. Braun and A. Furtwängler (eds), *Studien zur klassischen Archäologie. Festschrift zum 60. Geburtstag von Friedrich Hiller am 12. März 1986* (Saarbrücken), 3-21.
- Drerup, H. 1969. *Griechische Baukunst in geometrischer Zeit (Archaeologia Homerica II. O; Göttingen)*.
- Evans, A.J. 1930. *The Palace of Minos: a comparative account of the successive stages of the early Cretan civilisation as illustrated by the discoveries at Knossos*. Vol. 3. *The great transitional age in the northern and eastern sections of the palace: the most*

the verb *contigno* ('I join with beams'), originating from *con-* + *tignum* (beam, lumber, tree trunk, log). Cf. Engl. 'contignation: 1 archaic: a framing together of timbers: a joining especially of beams and boards. 2 archaic. a: framework, structure. b: floor, story' (Merriam-Webster Dictionary).

- brilliant records of Minoan art and the evidence of an advanced religion* (London).
- Felsch, R.C.S., Braun, K., Jacob-Felsch, M., Hübner, G., Nitsche, A., Salta, M. and Ellinger, P. 1987. 'Kalapodi. Bericht über die Grabungen der Artemis Alaphebolos und des Apollon von Hyampolis 1978-1982', *Archäologischer Anzeiger*, 1-99.
- Fokkens, H. 1999. 'Cattle and martiality: changing relations between man and landscape in the Late Neolithic and the Bronze Age', in C. Fabech and J. Ringtved (eds), 1999. *Settlement and landscape. Proceedings of a conference in Århus, Denmark, May 4-7 1998* (Århus), 35-43.
- Fokkens, H. 2003. 'The longhouse as a central element in Bronze Age daily life', in J. Bourgeois, I. Bourgeois and B. Cheretté (eds), *Bronze Age and Iron Age communities in North-Western Europe* (Brussels), 9-38.
- Gebhard, E. 2001. 'The Archaic Temple at Isthmia: Techniques of Construction', in M. Bietak (ed.), *Archaische griechische Tempel und Ägypten* (Vienna), 41-61.
- Gebhard, E. and Hemans, F. 1992. 'University of Chicago Excavations at Isthmia, 1989, part I', *Hesperia* 61.1, 1-78.
- Gruben, G. 1976. *Die Tempel der Griechen* (Munich).
- Guidoni, E. 1987. *Primitive architecture* (London).
- Gwilt, J. 1826. *The Architecture of Marcus Vitruvius Pollio: in ten books* (London).
- Hänsel, B. 1989. *Kastanas. Ausgrabungen in einem Siedlungshügel der Bronze- und Eisenzeit Makedoniens 1975-1979. Die Grabung und der Baubefund (Prähistorische Archäologie in Südosteuropa 7; Berlin).*
- Hansen, H.J. (ed.) 1971. *Architecture in Wood: A history of wood building and its techniques in Europe and North America* (London).
- Harris, R. 1979. *Discovering Timber-framed Buildings*, 2nd edn (Princes Risborough).
- Harris, R. 1980. *Timber framed buildings: A catalogue written by Richard Harris to accompany the touring exhibition Timber Framed Buildings* (London).
- Hellner, N. 2013. 'Neue Erkenntnisse zur Genese der dorischen Architektur', in I. Gerlach and D. Raue (eds), *Sanktuar und Ritual: Heilige Plätze im archäologischen Befund* (Rahden), 43-52.
- Hellner, N. 2014. 'Räumliche Führung am Beispiel der spatgeometrischen und archaischen Sud-Tempel von Abai/Kalapodi', in D. Kurapat, P.I. Schneider and U. Wulf-Rheidt (eds), *Die Architektur des Weges : gestaltete Bewegung im gebauten Raum : internationales Kolloquium in Berlin vom 8.-11. Februar 2012 veranstaltet vom Architekturreferat des DAI* (Regensburg), 289-307.
- Hemans, F.P. 2015. 'The Archaic Temple of Poseidon: Problems of Design and Invention', in E.R. Gebhard and T.E. Gregory (eds), *Bridge of the Untiring Sea: The Corinthian Isthmus from Prehistory to Late Antiquity* (*Hesperia* Supplement 48; Princeton, N. J.), 39-63.
- Hersema, O.H. 1992. 'Bronze Age Habitation and other archaeological remains near Hijken, province of Drenthe, the Netherlands', in C. Mordant and A. Richard (eds), *L'habitat et l'occupation du sol à l'Âge du Bronze en Europe. Actes du colloque international de Lons-le-Saunier 16-19 mai 1990* (Paris), 71-87.
- Hodge, A.T. 1960. *The Woodwork of Greek Roofs* (Cambridge).
- Holmes, A.M. 1995. *Regional variation of Early Archaic Greek Doric Temples in the Peloponnese, c. 675-550 BC* (unpublished PhD thesis, King's College, London).
- Jameson, M.H. 1973. 'The submerged sanctuary of Apollo at Halieis in the Argolid of Greece', *National Geographic Research Reports* 14, 363-7.
- Jameson, M.H. 1974. 'The excavation of a drowned Greek temple', *Scientific American* 231.4, 110-19.
- Jerem E., Vasáros Z. and Vicze M. (eds) 2010. *Turisztikai vezető a Százhalombattai Régészeti Park látóivalóhoz* (Budapest).
- Journot, F. 2013. 'Conception, industrie du pan de bois: questions posées', in C. Alix and F. Épaud (eds), *La construction en pan de bois au Moyen Âge et à la Renaissance* (Tours and Rennes), 111-25.
- Kolia, E. 2011. 'A Sanctuary of the Geometric period in ancient Helike, Achaea', *BSA* 106, 201-46.
- Kouremenos, K.E. 1984. *Ελληνική παραδοσιακή αρχιτεκτονική. Σαρακατσάνοι* (Athens).
- Küpper, M. 1996. *Mykenische Architektur: Material, Bearbeitungstechnik, konstruktion und Erscheinungsbild* (Espelkamp).
- Lawrence, A.W. 1957. *Greek Architecture* (Harmondsworth).
- Le Muet, P. 1623. *Manière de bastir pour toutes sortes de personnes* (Paris).
- Le T.V. 2006. 'Frame Structure of Vietnam Traditional Wooden Architecture', in P. Lourenço, P. Roca, C. Modena and S. Agrawal (eds), *Proceedings of the 5th international conference 'Structural analysis of historical constructions: possibilities of numerical and experimental techniques'*, New Delhi, India 6-8 November 2006 (New Delhi), 367-74.
- Lobisser, W.F.A. 2018. 'The Construction of a Bronze Age Longhouse Model in Dwelling-byre Style using Experimental Archaeological Techniques', *EXARC Journal* Issue 2018/2 (available online <<https://exarc.net/issue-2018-2>> accessed March 2022).
- Maiuri, A. 1958. *Ercolano. I nuovi scavi (1927-1958)*, Vol. 2 (Rome).
- Mallwitz, A. 1981. 'Kritisches zur Architektur Griechenlands im 8. und 7. Jahrhundert', *Archäologischer Anzeiger*, 599-642.
- Mazarakis-Ainian, A. 1987. 'Geometric Eretria', *Antike Kunst* 30, 3-23.
- McDonald, W.A., Coulson, W.D.E. and Rosser, J. (eds) 1983. *Excavations at Nichoria in Southwest Greece. Vol. III: Dark Age and Byzantine occupation* (Minneapolis).
- Misiego, J.C., Marcos, G.J., Martín, M.A., Sanz, F.J. and Villanueva, L.A. 2005. 'Guaya (Berrocalejo de Aragona, Ávila): Reconstrucción de la vida y economía de un poblado en los albores de la Edad del Hierro', in A. Blanco, C. Cancelo and A. Esparza, *Encuentro de Jóvenes Investigadores sobre Bronce Final y Edad del Hierro en la Península Ibérica, Salamanca, 20 al 22 de octubre de 2003* (Salamanca), 207-28.
- Morgan, L.H. 1851. *League of the Ho-de-no-sau-nee, or Iroquois* (Rochester).
- Morgan, L.H. 1965. *Houses and House-Life of the American Aborigines* (Chicago).

- Morgan, M.H. 1914. *Vitruvius: The Ten Books of Architecture* (Cambridge, Mass.).
- Moschonissioti, S. 1998. 'Excavation at ancient Mende', in M. Bats and B. d'Agostino (eds), *Euboica: L'Eubea e la presenza euboica in Calcidica e in Occidente. Atti del Convegno International di Napoli, 13-16 novembre 1996* (Naples), 255-71.
- Nabokov, P. and Easton, R. 1989. *Native American Architecture* (New York and Oxford).
- Nelson, M.C. 2017. 'The Architecture of the Palace of Nestor', in F.A. Cooper and D. Fortenberry (eds), *The Minnesota Pylos Project, 1990-1998* (Oxford), 283-383.
- Nielsen, P.O. 1999. 'Limensgård and Grødbygård. Settlements with house remains from the Early, Middle and Late Neolithic on Bornholm', in C. Fabech and J. Ringtved, J. (eds), *Settlement and landscape. Proceedings of a conference in Århus, Denmark, May 4-7 1998* (Århus), 149-65.
- Norberg-Schultz, C. 1966. *Intentions in Architecture* (Oslo).
- Oikonomos, G. 1931. 'Ο εκ του Αργείου Ηραίου πῆλινος οικίσκος κατά νέαν συμπλήρωσιν', *Αρχαιολογική Εφημερίς* 15, 1-53.
- Oliver, P. (ed.) 1997. *Encyclopedia of Vernacular Architecture of the World* (Cambridge).
- Palliardi, J. 1916. 'Hlinené modely neolithických chysí', *Časopis Moravského Musea Zemskeho*, 16, 41-52.
- Palyvou, C. 2005. *Akrotiri Thera: an architecture of affluence 3,500 years old* (Philadelphia).
- Palyvou, C. 2017. 'An architectural style of openness and mutability as stimulus for the development of an earthquake-resistant building technology at Akrotire, Thera, and Minoan Crete', in S. Jusseret and M. Sintubin (eds), *Minoan Earthquakes. Breaking the Myth through Interdisciplinarity* (Leuven), 249-66.
- Palyvou, C. 2018. *Daidalos at Work: A Phenomenological Approach to the Study of Minoan Architecture* (Philadelphia).
- Pantelidou-Gofa, M. 1991. *Η Νεολιθική Νέα Μάκρη: Τα οικοδομικά* (Athens).
- Perlès, C. 2001. *The Early Neolithic in Greece: The First Farming Communities in Europe* (Cambridge).
- Popham, M.R., Sackett, L.H. and Themelis, P.G. (eds) 1979-1980. *Lefkandi I: The Iron Age Settlement* (London).
- Post frame building design manual* 1999. National Frame Builders Association (Glenview, IL).
- Puglisi, S.M. 1951. 'Gli abitatori primitivi del Palatino attraverso le testimonianze archeologiche e le nuove stratigraphiche sul Germalo', *Monumenti Antichi* 41, cols. 1-98.
- Rasmussen, M. 1999. 'Livestock without bones. The long-house as contributor to the interpretation of livestock management in the Southern Scandinavian Early Bronze Age' in C. Fabech and J. Ringtved (eds), *Settlement and landscape. Proceedings of a conference in Århus, Denmark, May 4-7 1998* (Århus), 281-90.
- Renfrew, C. 1986. 'The excavated areas', in C. Renfrew, M. Gimbutas and E. S. Elster (eds), *Excavations at Sitagroi: A Prehistoric Village in Northeast Greece, Volume 1* (Los Angeles), 175-224.
- Rhodes, R.F. 1984. 'The Beginnings of Monumental Architecture in the Corinthia' (unpublished PhD thesis, University of North Carolina at Chapel Hill).
- Rhodes, R.F. 1987. 'Early Corinthian Architecture and the Origins of the Doric Order', *AJA* 91, 477-80.
- Ritchie, W.A. and Funk, R.E. 1973. *Aboriginal Settlement Patterns in the Northeast* (New York State Museum and Science Service Memoir 20; Albany, N.Y.).
- Sestini, V. and Somigli, E. 1978. *L'architecture Sherpa*, transl. by R. Frin (Paris).
- Schattner, T.G. 1990. *Griechische Hausmodelle. Untersuchungen zur Frühgriechischen Architektur* (Berlin).
- Sobon, J. and Schroeder, R. 1984. *Timber frame construction: all about post and beam building* (Pownal, Vt.).
- Soudský, B. 1969. 'Étude de la maison néolithique', *Slovenska archeologia*, 17.1, 5-96.
- Souvatzi, S. 2008. *A Social Archaeology of Households in Neolithic Greece* (Cambridge).
- Stellacci, S. and Rato, V. 2019. 'Timber-Framing Construction in Herculaneum Archaeological Site: Characterisation and Main Reasons for its Diffusion', *International Journal of Architectural Heritage* 15.3, 1-19.
- Tomlinson, R.A. 1976. *Greek Sanctuaries* (London).
- Touchais, G. 1983. 'Chronique des fouilles et découvertes archéologiques en Grèce en 1982 : Kalapodi', *BCH* 107, 774-9.
- Treuil, R. 1983. *Le Néolithique et le Bronze Ancien Egéens* (Athens and Paris).
- Tsakanika-Theohari, E. 2009. 'The constructional analysis of timber load bearing systems as a tool for interpreting Aegean Bronze Age architecture', in A. Kyriatsoulis (ed.), *Proceedings of the Symposium 'Bronze Age Architectural Traditions in the Eastern Mediterranean: Diffusion and Diversity', Munich 07-08.05.2008*, (Weilheim), 127-42.
- Tsakanika, E. 2017. 'Minoan structural systems: earthquake-resistant characteristics. The role of timber', in S. Jusseret and M. Sintubin (eds), *Minoan Earthquakes. Breaking the Myth through Interdisciplinarity* (Leuven), 267-304.
- Tsakanika, E. 2018. 'Timber-framed structures in Greece and their earthquake performance. Timber frames reinforced by masonry? Or timber reinforcements of masonry?', *ICOMOS Inter-ISC Meeting & Colloquium 'Anti-seismic Vernacular Heritage of Anatolia and Beyond', 10-13 July 2018, Kastamonu, Turkey* (Istanbul), 116-29.
- Tuck, J. 1967. 'The Howlett Hill Site: An Early Iroquois Village in Central New York', in E. Tooker (ed.), *Iroquois Culture, History, and Prehistory: Proceedings of the 1965 Conference on Iroquois Research* (Albany), 75-9.
- Ulrich, R.B. 2007. *Roman woodworking* (New Haven).
- Urbina, D., Morín, J., Ruiz, L.A., Agustí, E. and Montero, I. 2007. 'El yacimiento de Las Camas, Villaverde, Madrid Longhouses y elementos orientalizantes al inicio de la Edad del Hierro, en el valle medio del Tajo', *Gerión* 25.1, 45-82.
- Vintzileou, E., Zagkotsis, A., Repapis, C. and Zeris, C. 2007. 'Seismic behavior of the historical structural system of the island of Lefkada, Greece', *Construction and Building Materials* 21, 225-36.
- Vintzileou, E. 2011. 'Timber-reinforced structures in Greece: 2500 BC-1900 AD', *Proceedings of the Institution of Civil Engineers, Structures and Buildings*, 164.3, 167-80.
- Wace, A.J.B., Heurtley, W.A., Lamb, W., Holland L.B. and Boethius, C.A. 1921-1923. 'The Report of the School Excavations at Mycenae, 1921-1923', *BSA* 25, 1-434.
- Wace, A.J.B. 1949. *Mycenae: An Archaeological History and Guide* (Princeton, N. J.).

- Walker, J.N. and Woeste, F.E. 1992. *Post-frame building design* (ASAE Monograph No. 11; St. Joseph, MI).
- Wallace-Hadrill, A. 2011. *Herculaneum, Past and Future* (London).
- Wood Handbook: Wood as an Engineering Material* 2010. U.S. Department of Agriculture, Forest Service, Forest Products Laboratory, General Technical Report FPL-GTR-190 (Madison, WI).
- Stellacci, S. and Rato, V. 2019. 'Timber-Framing Construction in Herculaneum Archaeological Site: Characterisation and Main Reasons for its Diffusion', *International Journal of Architectural Heritage* 15.3, 1-19.
- Walter, H. 1990. *Das griechische Heiligtum: dargestellt am Heraion von Samos* (Stuttgart).
- Wang, J., He, J., Yang, N., Yang, Q. 2017. 'Study on Aseismic Characteristics of Tibetan Ancient Timber Structure', *Advances in Materials Science and Engineering*, Vol. 2017.1, 1-15.
- Waterbolk, H.T. 1975. 'Evidence of cattle-stalling in excavated pre- and protohistoric houses', in A.T. Clason (ed.), *Archaeozoological studies. Papers of the Archaeozoological Conference 1974, held at the Biologisch-Archaeologisch Instituut of the State University of Groningen* (Amsterdam), 386-94.
- West, T. 1971. *The Timber-frame House in England* (Newton Abbot).
- Winn, S. and Shimabuku, D. 1989. 'Architecture and sequence of building remains' in M. Gimbutas, S. Winn and D. Shimabuku (eds), *Achilleion: A Neolithic Settlement in Thessaly, Greece, 6400-5600 BC* (Los Angeles), 32-68.
- Wright, J.V. 1974. *The Nodwell Site* (Ottawa).
- Young, R.S. 1960. 'The Gordion Campaign of 1959: Preliminary Report', *AJA* 64, 227-43.
- Zwenger, K. 2015. *Wood and Wood Joints. Building Traditions of Europe, Japan and China* (Basel).

APPENDIX 2 CHOICE AND PROVENANCE OF WOOD, AND TAPER OF CENTRE POSTS IN THE LK-T BUILDING

by Alexandra Coucouzeli
with a contribution by Dimitrios Raptis

INTRODUCTION

The objective of this Appendix is to attempt to address three questions: (1) ‘What kinds of trees might have been used in the timber structure of the LK-T building?’; (2) ‘Where could the timber have been found?’; and (3) ‘What might have been the taper and therefore the upper diameter of the centre posts of the LK-T building, making them capable of supporting a ridge beam with a cross-section of 0.112m x 0.206m, placed on edge at their top, as reconstructed here (main article, Fig. 7; Appendix 3: III)’?. The first two questions are discussed in Section I, while the third question is addressed in Section II.

The potential answers to these questions would be useful for the reconstruction of the building and for the engineering analysis of its structural integrity. Question (3) also aims to address an issue raised by Herdt a few years ago. According to Herdt, the centre posts of the LK-T building could not have reached the total height of 9.80 m (including their part buried in the ground) suggested by the excavators (Popham et al. 1993, 46) (which is very close to the one reconstructed in the main article, Fig. 7) – because the centre post C4, which has the smallest *recorded* (my emphasis) diameter of all the (surviving) centre posts, equal to 0.18 m, (Popham et al. 1993, 16, table 2), would have tapered to less than 0.12 m at its top making it incapable of supporting a ridge beam with a minimum diameter of 0.12 m, the appropriate size to support a roof pitched at 45°, according to Herdt, without buckling (Herdt 2015, 207-8¹). However, it should be noted that the photo of the plaster cast made of the imprint left by C4 in its pit (Popham et al. 1993, pl. 30d) shows that the dimension 0.18 m is in fact the diameter of the lower end of the cast, at a depth of 0.80 m from floor level, while the upper end of the cast, i.e. the actual diameter of C4 at floor level, measures c.0.30 m, while the diameter shown in the published plans of the building is 0.28 m (Popham et al. 1993, plates 9, 38). We will take this fact into account in Section II, considering, for the sake of argument, 0.18 m as the diameter at floor level of a hypothetical centre post (see also Appendix 5: III.b).

I. CHOICE AND PROVENANCE OF WOOD IN THE LK-T BUILDING

Some logical assumptions

Since no analysis of the remains of wood ash from the posts of the LK-T building has been carried out, in order to at least know whether a broadleaf/hardwood or a coniferous/softwood species² was used, one can only make some logical assumptions about which tree species would meet the needs of the carpenters of the building and would be suitable for the centre posts and other long members of the timber frame and roof.

To begin with, the trees must have presented a number of technical characteristics, such as natural durability (i.e. decay resistance), especially for the posts embedded in the ground (Ulrich 2007, 261); a density such as to allow some degree of dimensional stability in the face of changes in atmospheric humidity (Fioravanti and Caramiello 1999, 85); and easiness of processing with hand tools and therefore softness, an even (i.e. smooth) texture, a straight grain, and absence or near absence of knots.³ Furthermore, one expects

¹ Herdt returned to this argument more recently (see Wilson Jones and Herdt 2022, 194-5).

² See, e.g., Flood 2019, 13, 68-9 with further references. In the temperate zone of the northern hemisphere, softwoods are generally conifers, whereas hardwoods are typically broadleaf trees (*Wood Handbook*, 3–2; Mantanis 2019, 5).

³ See *Wood Handbook*, 3-14–3-15, 5-26–5-30; Sobon and Schroeder 1984, 55, 56. Cf. Theophrastus (*Historia Plantarum* 5, *passim*). Theophrastus visualized a carpenter choosing the appropriate wood species according to three basic criteria: its density, *πικνότης* (vs porosity, *μανότης*), its heaviness, *βαρύτης* (vs lightness, *κουφότης*), and its hardness, *σκληρότης* (vs softness, *μαλακότης*) (*Historia*

the upright members of the timber frame, especially the centre posts, to have originated from well-formed trees, i.e. with a single, straight stem, without distortions and other deviations from the normal form (such as conicity, ellipticity, and unilateral curvature) and with a straight grain, without knots and fissures – defects which significantly decrease a tree's physical and mechanical strength^{4 5} –, as well as with a low degree of upward taper (that is, with a diameter that does not decrease sharply with the increase in their height, their shape being closer to a cylinder);⁶ one also expects those elements of the timber frame involving greater lengths and thicknesses, such as the crossbeams and the centre posts, to have come, of course, from tall trees, exceeding a height of 10 m.⁷

For the above conditions to be fulfilled, the trees must have been (a) from a forest or a 'closed' cluster, since trees grown in such conditions – particularly in high and virgin, dense forests with a strong competition for light – become tall, slender, single- and straight-stemmed, and less tapered, while their wood has fewer and smaller knots or is knot-free and is of higher density and therefore of superior quality for building;⁸ especially as far as the centre posts of the LK-T building are concerned, the trees must have been of approximately equal size from a forest or a close-spaced cluster at a particular stage of development;⁹ nowadays, in central and southern Greece, due to centuries of deforestation, most of the forests are very degraded and the total forest area has been seriously reduced (Meiggs 1982, 372), but surely on Euboea in the tenth century BCE, there were more virgin forests with taller trees, and hence substantial supplies of timber;¹⁰ (b) of a coniferous (and not a broadleaf) species, because their trunk is usually straighter¹¹ and provide softwood (as opposed to hardwood), which is generally soft or moderately soft, with moderate to low densities.¹²

Plantarum 5, passim); higher density, i.e. close-grained, woods tend to be heavier and are often harder than porous woods (Ulrich 2007, 239-40).

⁴ See As et al. 2006; *Wood Handbook*, 5-26, 5-27. Cf. Theophrastus: *The strongest wood is that which is without knots and smooth, and it is also the fairest in appearance.* (*Historia Plantarum 5.2.2*).

⁵ Indeed, the vast majority of the (surviving) squared (i.e. wall- and veranda) posts appear to have been straight, at least in their parts within the post pits. However, the skewed posts N3, S3, VS4, VS5, VS8 and VS9 may be the result of twisting, while the misaligned post N4 may be the result of bowing, two forms of wood warp (*Wood Handbook*, G-16, s.v. 'Warp'), which can develop particularly due to excessive longitudinal shrinkage, i.e. shrinkage parallel to the grain, as a result of the presence of some abnormal wood fibre, as in the case of wood with cross grain (as opposed to straight-grained wood) (such as wood with spiral, diagonal, interlocked grain, or localised cross grain from knots) (*Wood Handbook*, 3-14, 3-15, 5-27, 5-30, 7-3, 7-4); juvenile wood (where the grain in the growth rings closest to the pith, instead of being straight, is bent, angled or twisted, which causes longitudinal shrinkage that can be more than 10 times that of mature wood); and reaction wood (wood formed on one side of a trunk deflected from the vertical by more than 1° or 2°), which presents eccentric growth rings of varying width, the wider ones being prone to distortion, and undergoes excessive longitudinal shrinkage when subjected to moisture loss below its fibre saturation point, especially compression wood in softwoods/conifers or tension wood in hardwoods; when reaction wood and normal wood are present in the same piece of wood, unequal longitudinal shrinkage causes internal stresses that lead to warping (*Wood Handbook*, 3-13, 4-5, 4-7, 5-31, 5-32).

⁶ These are trees with an average diameter reduction factor of less than 1 cm/m (M. Diamantopoulou, pers. comm.).

⁷ The crossbeams can be reconstructed as measuring 0.225 x 0.30 m, with a length of 9.187 m (see main article, Figs 8 and 9; Appendix 3), while the centre posts, with a maximum diameter of 0.25 m (C2 – see Table A3: 1) or even 0.30 m (C4 – see Introduction), can be reconstructed as having an average total height of 10.02 m, i.e. 8.58 m (height above ground) + 1.44 m (average posthole depth of surviving centre posts) (see main article, Fig. 7; Table A3: 1). Note that, for instance, the 35-foot span to be covered by the crossbeams in the temple of Apollo at Delphi, may have needed timbers of up to 60 feet to get the thickness needed, since these were substantial timbers (Meiggs 1982, 431).

⁸ As these trees grow in the shade of a dense forest or stand, they reach skywards for light, so that their large branches are at the top, making the trunk tall and slender, straight, and less tapered; their wood has fewer and smaller knots or is knotless, because their lower branches, unable to receive sufficient light, wither and fall off while still quite young and small, after which the tree heals; their wood also tends to be of higher density, due to the slow growth caused by the shaded forest (Meiggs 1982, 119; Sobon and Schroeder 1984, 53-4; Crammond 1999, 5; Zwerger 2015, 14; M. Skarvelis, pers. comm.; D. Zianis, pers. comm.).

⁹ D. Raptis, pers. comm.; D. Zianis, pers. comm.

¹⁰ G. Mantanis, pers. comm.

¹¹ 'A coniferous (rather than a broadleaf) species would be preferred, because its trunk is usually straighter than that of a broadleaf that has a different crown configuration, which also affects the growth of the main trunk' (M. Diamantopoulou, pers. comm.); Zwerger 2015, 33.

¹² Mantanis 2019, 5, where the density of conifers is given as mostly <0.55-0.60 gr/cm³, except for a few pine species, such as *Pinus brutia* and *Pinus halepensis*. (*Pinus brutia* density = 0.46-0.69 gr/cm³; *Pinus halepensis* density = 0.45-0.62 gr/cm³.) Broadleaf species are hardwoods that generally have moderate, high to extremely high densities, mostly >0.55-0.60 gr/cm³ (Mantanis 2019, 5). Thus, Oak and Chestnut, two broadleaf/hardwood species available in central Euboea at the higher altitudes of Mount Dirphys (Fig. A2:1; Boratynski et al. 1988, 16, 28ff.) and which also grew on the island in antiquity (Oak: Ulrich 2007, fig. 12.3; Euboean Chestnut: Theophrastus, *Historia Plantarum 5.7.6*), are extremely unlikely to have been used in the LK-T building. Aegean Oak,

Finally, it is reasonable to assume that on Euboea in the tenth century BCE, the tree cover, in terms of species, was probably very similar to that of today.¹³

Types of conifer trees on Euboea

Based on a current forest map of Euboea (Fig. A2:1),¹⁴ there are four types of conifer trees available on the island, growing to a great height (up to 30 m or even 35 m), with a straight trunk, that would have been suitable for use in the LK-T timber frame. These conifers are, in decreasing order of wood quality, the following: (1) Cypress, *Cupressus sempervirens*; (2) Black pine, *Pinus nigra*; (3) Aleppo pine, *Pinus halepensis*, but of a type growing in a specific area of northern Euboea; and (4) Greek Fir, *Abies cephalonica*.

Let us now examine the suitability of the above-mentioned conifers for use in the LK-T building, considering each time their general characteristics, the quality of their wood (according to their chemical, physical and mechanical properties), their degree of use in the construction of buildings in modern and ancient times, the areas where they grow on Euboea nowadays, and the possible ways of transportation to Lefkandi in antiquity.

1. Mediterranean Cypress, *Cupressus sempervirens*

The Mediterranean Cypress, *Cupressus sempervirens*, is a forest species widely distributed throughout the Mediterranean region, growing from the coastal areas to high mountains (at altitudes up to 1200 m), and considered in Greece as the ‘giant of Greek woods’ due to its size, straightness, and excellent quality wood (Brofas et al. 2006, 646; Ulrich 2007, 249; Bektaş and Kurt 2010, 357; Kakaras 2013, 319-20; Nocetti et al. 2015; Caudullo and de Rigo 2016). *Cupressus sempervirens* may exceed 30.50 m in height¹⁵ and its trunks are usually well-formed, cylindrical (Bektaş and Kurt 2010, 358), and long (15-16 m).¹⁶

The wood of *Cupressus sempervirens* exhibits exceptional chemical, physical and mechanical properties (Table A2:1). The bark of the species contains high concentrations of phenolics, which are toxic or repellent to wood-destroying organisms (fungi, insects such as bark beetles and their symbiotic fungi, etc.).¹⁷ Thus, Cypress wood is highly resistant to decay (i.e. rot from fungi) and deterioration, and has a high natural durability (it is classified as ‘very durable’, i.e. lasting over 25 years),¹⁸ making it one of the most decay-resistant Greek species.¹⁹ It is also less flammable than pine (Brofas et al. 2006, 646).

The wood of *Cupressus sempervirens* is of moderate density and therefore moderately lightweight; thanks to the close growth rings that it contains, it has a low degree of shrinkage, which makes it one of the most stable woods in terms of dimensional change due to changes in atmospheric humidity (Paraskeuopoulou 1987, 30). The fact that Cypress wood is also water resistant (Caudullo and de Rigo 2016) makes it less prone to warping.

Cypress wood is moderately hard, characterized by a fine and even texture and a generally straight grain, with only small knots sometimes present, and is therefore easy to work with hand tools, without blunting

being a hardwood, was more difficult to process than conifers, and it rarely produced straight lengths over 30 feet (Meiggs 1982, 242, 444; see also Ulrich 2007, 169). Likewise, the Chestnut is hard to work with and although Theophrastus, referring to the Euboean sweet Chestnut (*Ευβοϊκή καρύα*), says that it *grows tall and is used for roofing*, he also implies that it had the disadvantage of splitting and cracking spontaneously, citing an incident in the public baths at Antandros (*Historia Plantarum* 5.7.6). Pliny says that the wood of this tree (which he confuses with the walnut tree – Meiggs 1982, 422), *is easily warped, but we sometimes see beams even made of it*, citing the incident at the baths of Antandros and obviously not recommending this species for the construction of buildings (*Natural History* 16.81), while Vitruvius does not mention it at all (Meiggs 1982, 240).

¹³ G. Mantanis, pers. comm.; Meiggs 1982, 372.

¹⁴ See also Boratynski et al. 1988.

¹⁵ Bektaş and Kurt 2010, 358; D. Raptis, pers. comm.

¹⁶ G. Mantanis, pers. comm.

¹⁷ See Krokene 2015, 183, 186, 188, 191-2. Like all non-pine conifers, and unlike conifers of the pine family, which includes, among others, Pine (*Pinus*) and Fir (*Abies*), Cypress has little or no resin-based stem defenses, because it lacks preformed resin structures (resin ducts or resin cells) in its bark and sapwood, so it rarely suffers from attacks of bark beetles and their associated fungi (Krokene 2015, 180, 183, 186).

¹⁸ Farjon 2010, 27; Nocetti et al. 2015; Caudullo and de Rigo 2016. This is true of the heartwood of old-growth cypress (as opposed to the wood of second-growth cypress, which is only moderately durable, i.e. lasting 10-15 years) (*Wood Handbook*, 2-11).

¹⁹ G. Mantanis, pers. comm.

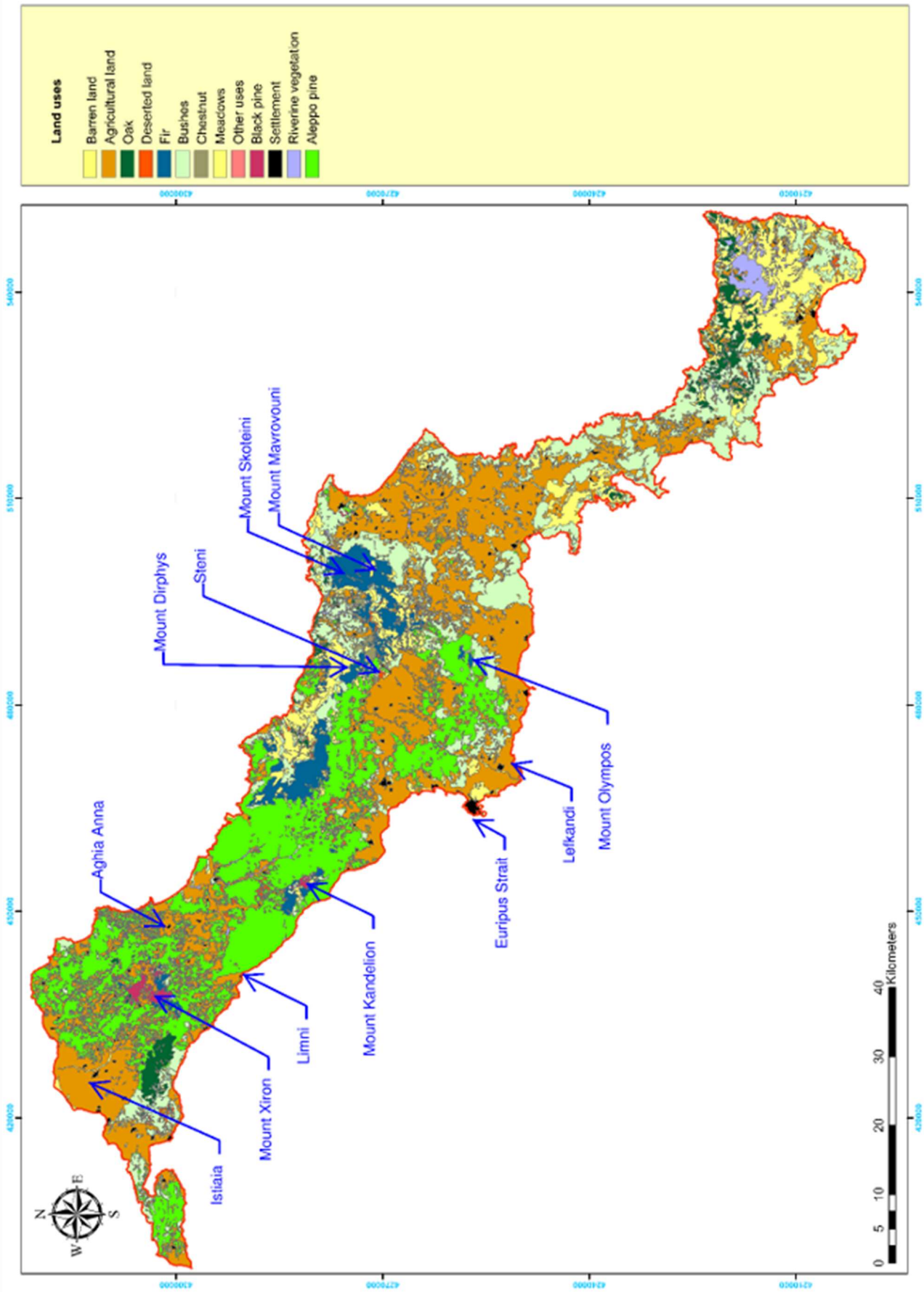


Fig. A2.1. Forest map of Euboea (map kindly provided by D. Raptis and adapted accordingly).

the cutting tools (only minimally).²⁰ It is also moderately strong (Paraskeuopoulou 1987, 30; Voulgarides 2015, 173),²¹ stronger than the wood of *Pinus nigra* and *Abies cephalonica*, although less strong than that of *Pinus halepensis* (Table A2:1). Cypress wood is particularly suitable for ‘areas requiring high strength’, ‘including flooring and roofing, where moderate impact strength is very important’, and in areas with important longitudinal stresses ‘such as beams, headers and poles’ (Bektaş and Kurt 2010, 361).

Finally, Cypress wood is appreciated for its good aesthetic traits: its natural luster and high polish, as well as its intense and aromatic scent (Ulrich 2007, 249; Nocetti et al. 2015; Caudullo and de Rigo 2016).

Although *Cupressus sempervirens* has better properties than any other tree species in Greece, able to provide the best structural wood, nowadays, it is very difficult to find building timber from *Cupressus sempervirens* in Greece.²² However, in ancient times, Cypress held a prominent place in the construction of important buildings (Nocetti et al. 2015 with refs.; Caudullo and de Rigo 2016, 88). It was used in palaces and temples, both in structural constructions (roofs, supports, floor joists, etc.) and in outdoor constructions (doors, portals). Thus, Cypress appears to have been used in the timber-frame structure of the palace of Knossos.²³ In ancient Greece and Rome, we learn from the written sources that cypress was highly prized for being ‘proof against decay’ (Theophrastus, *Historia Plantarum* 5.4.2; Pliny, *Natural History* 16.78, 16.81) ‘and all attacks of wood-worm’ (Pliny, *Natural History* 16.81), and for being the wood that ‘seems to last longest’ (Theophrastus, *Historia Plantarum* 5.4.2) or the ‘most durable’ alongside ebony and cedar (Pliny, *Natural History* 16.79). Vitruvius explains that cypress (alongside pine), *although ... apt to warp when used in buildings on account of [its] superfluity of moisture, yet [it] can be kept to a great age without rotting, because the liquid contained within [its substance]²⁴ has a bitter taste which by its pungency prevents the entrance of decay or of those little creatures which are destructive. Hence, buildings made of these kinds of wood last for an unending period of time.* (*De architectura* 2.9.12). Cypress was also considered as ‘the only wood which takes a fine polish’ (Theophrastus, *Historia Plantarum* 5.4.1), ‘the only kind of wood that maintains its polish to all future time’ (Pliny, *Natural History* 16.81), and one that is ‘never known to split or crack spontaneously’ (Pliny, *Natural History* 16.78).

In classical Greece, cypress wood was highly valued and very expensive and was used for the roof-timbers of the temple of Apollo at Delphi, probably also of the Parthenon (Meiggs 1982, 200-2, 425, 430-2, 437), while both in ancient Greece and Rome, it was one of the first choices for the monumental doors of temples.²⁵

The highly durable and fragrant wood of Cypress appears to have been ‘the wood of gods and kings’ probably connected with a belief that ‘it would last forever’, as was the case for cedar (Ulrich 2007, 150).²⁶ Indeed, Cypress ranks only fourth among the timbers listed by Theophrastus as being commonly used for house building (*Historia Plantarum* 5.7.4²⁷) and, as Meiggs remarks of the wide use of Cypress in temples, ‘length of life was more important for temples than for secular buildings’ (Meiggs 1982, 200).

Away from the classical world, Cypress was used in Mesopotamia for the temple of Ninġirsu by Gudea (Wagner Weick et al. 2023, 206), in Assyria for the roofing of temples and palaces (Meiggs 1982, 78, 418-420), and in Persia for monuments of the Sassanian period associated with temples (Wagner Weick et al. 2023,

²⁰ G. Mantanis, pers. comm.; Bektaş and Kurt 2010, 358; Nocetti et al. 2015. Especially *Cupressus sempervirens* var. *horizontalis* presents a lower number of knots and a lower knot size, due to its fewer branches and their wider angle of insertion into the trunk (Nocetti et al. 2015).

²¹ The strength of wood is usually determined based on mechanical properties such as bending strength (modulus of rupture/MOR in bending), compression strength parallel to grain, compression strength perpendicular to grain, and shear strength parallel to grain (*Wood handbook*, 5-3).

²² M. Skarvelis, pers. comm.

²³ Meiggs 1982, 99; see also Appendix 1, Section B.2.2.2., Fig. A1:19.

²⁴ By ‘substance’ Vitruvius means ‘resin’ (cf. *De architectura* 2.9.13: *the cypress and pine yield resin*).

²⁵ In the Greek world, this was the case of the doors of the Temple of Artemis at Ephesus – which Vitruvius cites as *a good proof* for the durability of cypress, adding that cypress wood was also chosen here because *it is the only kind of wood that maintains its polish to all future time* (*De architectura* 16.79) –, the ‘great door’ of the temple of Asklepios at Epidaurus, and probably also the eastern door to the Parthenon (Meiggs 1982, 200, 425, 449; Ulrich 2007, 249).

²⁶ It is worth noting in this respect that cypress wood was also used for coffins in ancient Greece and Egypt, and for the sarcophagi found in Crimea (see Meiggs 1982: 294; Ulrich 2007, 249; Asensi Amorós 2016, 5, 6, 8-11; Wagner Weick et al. 2023, 207).

²⁷ *For house-building ... is used fir, pine and prickly cedar; also cypress, oak and Phoenician cedar.*

210);²⁸ the temple of Solomon in Jerusalem (tenth century BCE) was built of cypress (and cedar) supplied by Hiram I of Tyre and sent by sea (Meiggs 1982, 69-70, 416-20; Kalimi 2018, 285-6, 288);²⁹ and in traditional Chinese and Japanese architecture, cypress has been used in the construction of temples and other ceremonial buildings (Farjon 2010, 28).

The valuable wood of cypress would have constituted the best choice for a high-status construction such as the LK-T building, where it could have been used both for the posts (which being embedded in the ground were exposed to decay) and for the roof.

Nowadays, natural stands or rather remnants of natural populations of Cypress occur on Crete, Rhodes, Kos, Samos, Symi, and Melos (Papageorgiou et al. 2005, 119; Brofas et al. 2006, 646). The spread of Cypress in Euboea is sporadic, with the vast majority being planted trees, rather than natural clusters; these small groups cannot be mapped on the forest map of Euboea.³⁰ Concerning ancient times, although there is no indication in the written sources that Euboea was rich in Cypress,³¹ this species would have grown throughout the island in greater density³² and arguably in larger sizes, as the natural clusters of cypress trees that exist around the Mediterranean today are only the remains of more extensive forests, the result of the intensive exploitation of cypress wood over many centuries since antiquity as well as other factors, including canker disease (Paraskeupoulou 1987, 28; Papageorgiou et al. 1994, 2, 14; Brofas et al. 2006, 647, 656; Farjon 2010, 28; Caudullo and de Rigo 2016, 89), which in Greece was first detected on *Cupressus sempervirens* on Euboea in 1962 (Papageorgiou et al. 2005, 119); furthermore, apart from its natural forests or stands, the cypress must have been cultivated in Greece since ancient times (Paraskeupoulou 1987, 26).³³

If there were sufficient stands of Cypress in central Euboea for use in the LK-T building, they could have been carried to the site, depending on location and distance, via the Lelas River and/or by yokes of oxen (or mules), the transport by river being easier and less expensive than the transport by land.³⁴ Lefkandi was indeed fortunate to be situated only at a (straight line) distance of c. 1.1 km from the Lelas River, the greatest Euboean river, as it flowed toward its delta. The seasons when the Lelas River flows and is navigable, autumn-winter and spring, would have suited respectively the ideal felling time of trees used for the ‘squared’ timbers of the LK-T building and that of trees that needed to be barked to provide ‘round’ timbers used for the centre posts.³⁵

²⁸ There is no evidence that Cypress was used for structural purposes by the Romans, who associated it primarily with parks and cemeteries, and found it useful for marking boundaries and producing poles (Pliny, *Natural History* 16.140-41) (Meiggs 1982, 242-3). Pliny notes that [t]he wood that it furnishes is but scanty (*materie rara*), has funerary connotations and is used in *hedge-rows, or ... in ornamental gardening* (*Natural History* 16.60).

²⁹ On the historicity of Solomon’s temple and its dating (within Solomon’s reign), see Kalimi 2018, 73-4, 272 ff. with refs.

³⁰ P. Trigas, pers. comm.; Forest Service Office of Chalcis, Euboea, pers. comm.; Eleutheriadou and Theodoropoulos 2001, 4.

³¹ As opposed to the ‘*great abundance*’ of cypress trees on Crete and Rhodes, and in Lycia (Theophrastus, *Historia Plantarum* 4.5.2) (Meiggs 1982, 46, 99, 426, 437) or the apparent abundance of cypresses in the Peloponnese (Meiggs 1982, 35, 431-2) and in Cnidus (Meiggs 1982, 211).

³² Ulrich 2007, 249 with Fig. 12.2, a map showing the distribution of Cypress throughout Euboea during antiquity.

³³ It is interesting to note in this regard that, until the 1970s, there was a custom in Greece that when children were born, their parents would plant a field of cypress trees so that when the children grew to the age of 20-25 years, they would have at their disposal the most suitable wood to build their house, since in 20-25 years the cypress reaches, depending on the quality of the soil, a diameter of 0.25-0.28 m and a height exceeding 13 m (G. Mantanis, pers. comm.; see also <<https://dasarxeio.com/2015/02/02/19452/>> accessed April 2023).

³⁴ On the superiority of water transport in antiquity, see Meiggs 1982, 335 ff. On the transport of timber by oxen (or mules), see Meiggs 1982, 332-3, 339-41, 429, 432. Each long timber would have probably needed two yokes of oxen (Meiggs 1982, 429, 432).

³⁵ Theophrastus makes the distinction between the right season for cutting round timbers (*στρογγύλα ξύλα*), whose bark is to be stripped, which is when the tree is coming into leaf, i.e. in spring (because then the moisture under the bark makes ‘peeling’ easy, while the wood itself is of better colour and does not turn black), and that of squared timbers (*τετράγωνα ξύλα*) and any wood, in general, which is when it ... has ... ripened its fruit, the best season as to strength (*Historia Plantarum* 5.1.1); he also adds that since they strip the bark of hardly any trees except fir, mountain pine and coastal pine, these trees are cut in the spring (*Historia Plantarum* 5.1.2). Theophrastus is followed by Pliny, who refers to round trees that are wanted for barking, for instance, [those] that are employed in temples and for other purposes and adds that [s]quared logs, and wood from which the bark has been lopped, are generally cut in the period that intervenes between the winter solstice and the prevalence of the west winds (*Natural History* 16.74) and that, according to Cato, [t]he proper time for cutting a tree is when the seed is ripe (*Natural History* 16.75). Cf. Vitruvius (*De architectura* 2.9.1-2), for whom the best season for felling trees, in general, is the period between early October and the time when Flavonius (the west wind) begins to blow, i.e. autumn and winter, and in any case before spring, when ‘all trees become pregnant’. See also Meiggs 1982, 331. Indeed, a log cut in the spring when the sap is flowing may have a moisture content of more than 100%

2. Black pine, *Pinus nigra*

The Black pine, *Pinus nigra*, a type of pine that grows only in mountainous areas (at altitudes 400-2000 m) and native to Euboea, can reach 30.40 m in height (Raptis et al. 2021, 1170) and provides very straight and tall logs, 18-20 m in length.³⁶

Concerning its chemical properties, Black pine wood is relatively resistant to insect attack and fungal infection, being rich in (terpenoid) resin (which is stored in its bark and sapwood) and, like all conifers, also rich in phenolics (which are stored in its bark); paradoxically, although it has the most elaborate resin-based defenses, Black pine, as all pines, is most vulnerable to the attacks of insects and their symbiotic fungi, which are attracted to the volatile terpenoids in its resin (Krokene 2015, 186, 188-92, 197); thus, compared to cypress, Black pine is much more liable to decay and much less durable (it is rated as ‘slightly durable’, i.e. lasting between 5-10 years)³⁷ (Table A2:1). Due to its resin content, Black pine is also flammable.

The wood of *Pinus nigra* has a moderate density and is therefore moderately light in weight (Table A2:1); it is moderately hard, with a medium, even but coarse texture and a straight grain, with small knots; it is thus easy to work with and is processed satisfactorily with hand tools.³⁸

Pinus nigra wood is moderately low in strength; it is less strong than *Pinus halepensis* and *Cupressus sempervirens*, but stronger than *Abies cephalonica* (Table A2:1).

Black pine therefore provides good quality wood, although of a lower grade than Cypress (Isajev et al. 2004). Today, Black pine is among the mountain pines commonly used in buildings and is considered the pine *par excellence* for general construction (Farjon 2010, 745; Enescu et al. 2016; Kouvara 2019, 15, 18). Likewise in antiquity, mountain pines, such as the Black pine, were the pines most used in building construction (Meiggs 1982, 44) and (along with firs) the trees most used for building-timbers (Meiggs 1982, 23), being capable of providing the longest roofing beams (Meiggs 1982, 119, 241; Ulrich 2007, 256). Theophrastus writes that mountain-pines (alongside firs) ‘are the most useful trees ... and their timber is the fairest and largest’ (*Historia Plantarum* 5.1.5) and places them (along with firs) at the top of his list of woods used in house building (*Historia Plantarum* 5.7.4). He cites the pine of Mount Ida (*Ἰδαία πεύκη*), a tree of the ‘female’ kind, as he says, as representative of the mountain-pine or Black pine, *Pinus nigra*,³⁹ in contradistinction to *πίτυς* or the pine of the sea-shore (*παραλία πεύκη*), a tree of the ‘male’ kind, as he says, which in Greece is the Aleppo pine, *Pinus halepensis* (*infra*) (Meiggs 1982, 35, 469) (*Historia Plantarum* 3.9.1-3.9.3).⁴⁰

Theophrastus states that the wood of the mountain-pine is naturally proof against decay thanks to its resin (*Historia Plantarum* 5.4.2, 5.7.1⁴¹) and that it is for this reason that merchant ships are made of this wood (*Historia Plantarum* 5.7.1). Pliny, too, points to the good moisture resistance of *pinus*, when he writes that it was used for making underground water pipes (*Natural History* 16.81; see also Ulrich 2007, 256), while

(*Wood Handbook*, 6–22). Nowadays, it is considered that the optimal time to fell trees for construction is the period from early autumn to early winter, to ensure minimum moisture in the trees (Seeley 1980, 89).

³⁶ G. Mantanis, pers. comm. The tallest mountain pines can provide logs over 18 m in length (Meiggs 1980, 241; Ulrich 2007, 256).

³⁷ G. Mantanis, pers. comm.

³⁸ Isajev et al. 2004; Voulgarides 2015; 174; Kouvara 2019, 15, 18; G. Mantanis, pers. comm.

³⁹ Mount Ida, modern Mount Psiloreitis, the highest mountain of Crete, is covered with forests of Black pine at its higher altitudes and is in fact the only location with Black pine on the island (see <<https://filotis.itia.ntua.gr/biotopes/c/A00010069/>> accessed April 2023).

⁴⁰ I am using, here and in what follows, the translation of Theophrastus’ *Historia Plantarum* by Hort (1916). Theophrastus uses the words *ελάτη* and *πέυκη* for fir and mountain-pine, respectively. In Hort’s translation, *ελάτη* and *πέυκη* are respectively translated as *silver-fir* and *fir*, apparently due to an old, pre-19th century habit of referring to pines as ‘firs’ (from the Old Norse *fura*, whose Germanic cognates are still used for pines in some European languages (Danish, Norwegian, Swedish, Dutch, and German). I have therefore substituted Sir Arthur Hort’s *silver-fir* and *fir* by *fir* and *mountain-pine*, respectively. *Idaia peuke* is translated by Hort as *Corsican pine*, which is a variety of Black pine, *Pinus nigra* (known as *Pinus nigra* subspecies *laricio*) with a very straight trunk, native only to the island of Corsica. In the translations of other ancient Greek texts referring to *πέυκη* (Plato, Diodorus), the word is translated as ‘pine’ and so is also translated by Meiggs (see Meiggs 1982, *passim*). Meiggs translates *ελάτη* and *πέυκη* respectively as *fir* and *mountain pine*, the latter as opposed to *coastal pine* (*πίτυς*) (translated by Host as Aleppo pine) (see Meiggs 1982, 118 and *passim*); thus, Meiggs refers to *peuke*-pine and to *pity*-pine (Meiggs 1982, 469).

⁴¹ *pine ... does not decay* (*Historia Plantarum* 5.7.1) and that the *resinous pine* (*πέυκη ένδαδος*) is [n]aturally proof against decay (*Historia Plantarum* 5.4.2). As another proof of the mountain-pine’s capability not to decay, Theophrastus writes that *merchant ships [are made] of mountain-pine* (*πέυκη*), because it does not decay (*Historia Plantarum* 5.7.1). This is because ‘merchantmen had to stay at sea for long periods and strength was more important than speed’ (Meiggs 1982, 118).

Vitruvius adds that, due to its resin content, when mountain-pine is used in buildings, these can last for a very long time without decaying, as in the case of cypress (*De architectura* 2.9.12) (*supra*).

Theophrastus also writes that the wood of the mountain-pine is heavy because it is resinous (*Historia Plantarum* 3.9.7, 5.1.5) and that mountain-pines (alongside firs) are *the fairest trees for carpentry, their wood being the closest* (*πυκνότεστα*, densest) (*Historia Plantarum* 5.1.9). He further writes that the wood of the mountain-pine *has more knots* than that of the fir (*Historia Plantarum* 3.9.7) and that its *knotty parts* make it one of *[th]e most difficult woods [to work]* (*Historia Plantarum* 5.5.1). Comparing the mountain-pine to the coastal pine (*παραλία πεύκη*), i.e. the Aleppo pine, *Pinus halepensis*, he says that *it is less resinous, less soaked with pitch, smoother, and of straighter grain* (*Historia Plantarum* 3.9.3). Finally, Theophrastus writes that mountain-pines (alongside firs) are strong for bearing weight and with *an upward thrust* (*Historia Plantarum* 5.6.1).

Black pine would not have been available locally at Lefkandi, since it only grows on high mountains. Today, Black pine is found only in the northern part of Euboea and, if this species was to be assumed to have been used in the LK-T building, based on present-day data, it would have been felled from its main source on Mount Xiron, in the forest of Limni (Kouvara 2019, 7 and *passim*) (Fig. A2:1): the logs would have had to be carried by yokes of oxen (or mules) to the seashore of Limni (ancient Elymnion), over a distance of *c.* 18 km,⁴² and then transported by sea,⁴³ along the western coast of the island, to the shore of Lefkandi over a distance of *c.* 54 km (Fig. A2:1). However, such a long trajectory would have been costly and, moreover, it would have involved risks, due to the strong tidal currents of the Euripus Strait, in Chalcis.⁴⁴ ⁴⁵ This may have been a strong deterrent in the choice of the northern Euboean Black pine by the LK-T carpenters, if suitable timber, such as Cypress, was available in central Euboea and involved fewer obstacles in transport.⁴⁶

3. Aleppo pine, *Pinus halepensis*

The Aleppo pine, *Pinus halepensis*, is a species characteristic of the Mediterranean, growing at coastal and low altitudes (up to 850 m); it is also a species native to Euboea (Chambel et al. 2013; Papadima 2014, 29; Mauri et al. 2016, map 1). The typical Aleppo pine is a medium size tree usually growing up to 15-20 m (Mauri et al. 2016, 122; Elaieb et al. 2017, 20; Farjon 2020, 702), with a trunk that is often not straight, showing various deformations, which decrease the quality of its wood.⁴⁷

⁴² There are also clusters of Black pines on Mount Kandelion, in the northern part of the island, closer to Lefkandi (Fig. A2:1); however, in this case, the transportation to the seaside would have been very difficult, if not impossible, due to the steep descent.

⁴³ For the transport of timber by sea in ancient Greece and Rome, see Meiggs 1982, 200, 204, 209, 211, 364; Ulrich 2007, 254, 263-4, 268. Concerning the Near East, we know about the supply of Egypt in timber from Cyprus and Phoenicia by sea (Meiggs 1982, 14, 63-68), of Assyria from Phoenicia by sea (Meiggs 1982, 14, pl. 3A), as well as about the transport of the timber for Solomon's Temple from Phoenicia to the Land of Israel by sea (Meiggs 1982, 69-72; Kalimi 2018, 285-6); the latter were sent by rafting (Hiram, king of Tyre, tells Solomon: '*My servants will bring [the logs] down from Lebanon to the sea, and I will make them into rafts to go by sea to the place you indicate*').

⁴⁴ The waters of the Euripus Strait, which is 39 m wide and 40 m long, are constantly moving (high- and low tides), while at the same time changing direction, sometimes heading towards the North Euboean Gulf and sometimes towards the South Euboean Gulf. Assuming that, at that time, there was a good knowledge of the movement of the waters of the Straits, the logs could have been transported through the latter only on those 22-23 days of each month (11-12 days around the new moon and as many around the full moon), when the current show a regularity, changing direction approximately every 6 hours (followed by 6-15 minutes of stagnation period) and only at certain times within the approx. 6-hour intervals during those days, i.e. in the approximately 3-hour period when the current has a N-S direction and, of course, also in daylight. Note, however, that on the days when the current is regular, the tides are intense and the currents stronger, gaining even more speed when strong southerly winds are blowing (Eginitis 1929; see also A. Antoniou online <<https://www.antonios-antoniou.gr/evripos>> accessed May 2023).

⁴⁵ The same would be true for the transfer of the Black pine of northern Euboea along the eastern coast, then all around the southern end of the island, through Kaphireus Strait, known for its strong currents.

⁴⁶ Another potentially forbidding factor, which may have also applied to the felling of Black pine and Fir on Mount Dirphys, could have been the possible inaccessibility of these areas being under the control of enemy populations (tribes?) or due to 'competition for the exploitation of forest resources/products (timber, resin, honey, beeswax ...)' between local populations (tribes?), with the ensuing 'possibility of violence and violent death', especially after the 'advent of iron tools/'iron working techniques', which may have prompted an 'expansion on to the forested' areas of the island, unless one is to assume that the LK-T ruling elite was getting on with the neighbouring communities of the mountains of central Euboea (in the case of Black pine and Fir) or they had 'extended their power and networks of influence in the much wider region towards the mountains' and northern Euboea (cf., e.g., the situation in the Upper Guinean forests of the Liberia/Sierra Leone region – Richards 1996, 62-5, 68-9).

⁴⁷ This pine species and, more generally, the coastal pines, being photophilic organisms, do not form 'closed' clusters and, as a result, they are branch-shaped, presenting bent stems and other deformations and large knots, which weaken their wood quality

Like most Pine (*Pinus*) species, Aleppo pine has a low natural durability (it is classified as ‘slightly durable’, lasting 5-10 years) (Elaieb et al. 2017) (Table A2:1), due to its high resin content, which also renders it highly flammable (Papadima 2014, 30).

Aleppo pine wood is moderately dense and moderately strong,⁴⁸ and is the heaviest and strongest wood of the four conifer species examined (Table A2:1). It is processed relatively well with hand tools,⁴⁹ being moderately hard to hard, with a characteristic ‘pine’ texture and, in the case of the typical Aleppo pine, with a twisted grain and a large number of knots, which together with the high amount of resin it contains, make its sawing less efficient (Elaieb et al. 2017, 30).

Pinus halepensis provides low quality wood and is therefore of very limited use as a wood material (Elaieb et al. 2017, 30);⁵⁰ instead, it is used as firewood, and to produce honey and especially resin (Papadima 2014, 33; Mauri et al. 2016), with resin collection causing the tree to deform, further decreasing the quality of its wood.⁵¹ Likewise in antiquity, the coastal pines were less used in building construction (Meiggs 1982, 23, 44), being considered as producing timber of inferior quality (Ulrich 2007, 256) and valued more for their resin (Ulrich 2007, 256, 264; Mauri et al. 2016, 123). Theophrastus refers to the typical Aleppo pine when he compares the *pine of the sea-shore* (*παρὰ τὴν θάλασσαν*) or ‘male’ pine to the pine of Mount Ida (*Pinus nigra*) or ‘female’ pine (*supra*) and describes it as being shorter and *more twisted*, with a timber that is *stronger*, but also *tough* and thus *harder to work*⁵² and *warp[ing] in joinery work* (*Historia Plantarum* 3.9.1-3.9.3).

On Euboea, the Aleppo pine is the most abundant tree. Its forests dominate the coastal plains and low hills in the central and especially the northern part of the island, accounting for one fifth of the latter’s total forest area (Fig. A2:1).⁵³

The Aleppo pine that would be suitable for use by the LK-T carpenters is not the typical Aleppo pine – which would be readily available locally but inadequate, due to its small size, often bent or distorted trunk and high number of knots (*supra*) – but a type that grows in the forest stands of northern Euboea, mainly in the area between Limni – Aghia Anna – Istiaia, and which, due to different environmental conditions (warm climate with high rainfall and nutrient-rich soil) is, exceptionally for this species, of a different form, with tall, straight trunks,⁵⁴ reaching 25-32 m.⁵⁵ It would therefore have been able to provide long timber for construction,⁵⁶ and wood of better quality, with fewer knots, compared to the typical Aleppo pine, and with even better mechanical properties than Black pine.⁵⁷ However, this type is also exploited for its resin, a practice that causes trees to deform and reduces the quality of the wood;⁵⁸ this would also have been the case in antiquity,⁵⁹ although it is expected that resin collection would be less extensive, with few deformed trees as a result.

The Aleppo pine of northern Euboea would have had to be transported to Lefkandi in the same way as the Black from this region, a long and risky trajectory (*supra*). It is therefore less likely to have been used in the LK-T building, as in the case of the Black pine.

(Meiggs 1982, 44; Crammond 1999, 6; Chambel et al. 2013; Elaieb et al. 2017, 21, 30; Farjon 2020, 702; M. Skarvelis, pers. comm.; D. Zianis, pers. comm.).

⁴⁸ Crammond 1999, 13, 25; Elaieb et al. 2017, 22; ‘Aleppo Pine wood is extremely strong, it is better than Cypress’ (M. Skarvelis, pers. comm.).

⁴⁹ G. Mantanis, pers. comm.

⁵⁰ Today, it is almost impossible to find Aleppo pine timber commercially in long lengths (M. Skarvelis, pers. comm.)

⁵¹ The extraction of resin by tapping using the ‘debarking’ (bark-peeling) method damages the tree up to a height of c.4 m (Forest Service Office of Limni, Euboea, pers. comm.; also, Spanos 2010, 38-39), causing intense injuries in its trunk and leading to deformation of the wood, the formation of callous tissue, and discoloration (Papadopoulos 2013, 51).

⁵² Cf. Theophrastus’ criteria for a wood difficult to work: *those [woods] are difficult which are hard and have many knots and a compact and twisted grain* (*Historia Plantarum* 5.5.1).

⁵³ Boratynski et al. 1988, 36, fig. 106; Daskalidou et al. 2014, 55-56.

⁵⁴ A. Papadopoulos and M. Skarvelis, pers. comm.; Daskalidou et al. 2014, 56, 67; Papadima 2014, 30. Cf. Crammond 1999, 6.

⁵⁵ Papadima 2014, 30; A. Papadopoulos, pers. comm.

⁵⁶ A. Papadopoulos, pers. comm.; M. Skarvelis, pers. comm.

⁵⁷ M. Skarvelis, pers. comm.

⁵⁸ Spanos 2010; Papadopoulos 2013. See also *supra*.

⁵⁹ On the extraction of resin from coastal pines (*pitys*-pines) for use in the production of pitch for building-timbers and for ships, as well as in the production, preservation and flavouring of wine (the latter being a common practice on Euboea), see Meiggs 1982, 467-71.

4. Greek Fir, *Abies cephalonica*

The Greek Fir, *Abies cephalonica*, is a tree species native to central and southern Greece, including Euboea (Boratynski et al. 1988, 36, fig. 105), thriving on high mountains (at altitudes ranging between 600-2000 m) (Farjon 2010, 71).

Greek fir is a very straight tree and can reach up to 30-35 m (Farjon 2010, 70)(cf. Homer, *Odyssey* 5, 239: *ἐλάτη οὐρανομήκης*, *fir reaching to the skies*), being the tallest of all four conifers available on Euboea, and therefore capable of supplying the longest timbers.

The wood of the Greek fir is of mediocre quality (Caudullo and Tinner 2016, 50). It is considered to have low natural durability (it is classified as ‘not very durable’, i.e. lasting 5 to 10 years)⁶⁰ (Table A2:1), showing no biological resistance to fungi and insect attack, and therefore being much more susceptible to degradation than the more valuable woods of Cypress and Pine.⁶¹

Abies cephalonica wood has a low density and is therefore lightweight (Farjon 2010, 27), being the lightest of the four conifers examined here (Table A2:1). It is relatively soft, although sometimes moderately hard, mostly straight-grained; it may contain many large and hard knots; and it is processed very satisfactorily with hand tools.⁶²

In terms of mechanical properties, the wood of the Greek fir is moderately low in strength – in fact, it has the lowest strength properties of the four Euboean conifer species (Table A2:1).

Nowadays, the wood of Greek fir is used for interior construction purposes, mainly roofs,⁶³ for framing material, plywood, etc. (Farjon 2010, 27; Alizoti et al. 2011). In ancient Greece and Rome, fir (alongside pine) was used widely both in ship-building and general construction (Meiggs 1982, 23, 43) and, in Rome, especially, ‘to bridge the largest spans’ of great buildings (Ulrich 2007, 243). Fir already figures prominently in Homer as the tallest of trees, growing heaven-high (*ἐλάτη οὐρανομήκης*) (*Odyssey* 5.239), the palace of Odysseus has beams of fir (*εἰλάτιναι δοκοί*) (*Odyssey* 19.38) and *the lofty hut which the Myrmidons had builded for their king*, Achilles, had posts of fir (*δοῦρ’ ἐλάτης*) (*Iliad* 24. 448-451) (see also Meiggs 1982, 109, 111).

About fir, in general, Theophrastus states, as already mentioned, that together with the mountain-pine, they are the most useful trees providing the finest and longest timber (*Historia Plantarum* 5.1.5), and puts it, along with the mountain-pine, at the head of the list of woods employed in house building (*Historia Plantarum* 5.7.4). He hastens, however, to point out that *they differ from one another in many respects*: the timber of the fir is *light and without resin*, in contrast with the *heavy and resinous* timber of the mountain-pine (*Historia Plantarum* 5.1.5), adding that the fir *gives timber of the greatest lengths and of the straightest growth* (*Historia Plantarum* 5.1.8), given that *in stature [fir] is large, much taller than the [mountain-] pine* (*Historia Plantarum* 3.9.6). He also writes that fir wood (alongside the wood of mountain-pine) is *the closest* (= densest) (*Historia Plantarum* 5.1.9), that it is *fibrous, soft and light* (*Historia Plantarum* 3.9.7) and that, although it has fewer knots than the wood of the mountain-pine, its knots are *harder* than those of the latter and *indeed they may be said to be harder than those of any tree, though the wood otherwise is softer* (*Historia Plantarum* 3.9.7), making it one of *[th]e most difficult woods [to work]* (*Historia Plantarum* 5.5.1).⁶⁴ Theophrastus also states that *[f]or bearing weight fir is a strong wood* (*Historia Plantarum* 5.6.1).

However, the ancient sources mention the inferior quality of the fir of central and southern Greece, which was represented in their eyes by the firs of Euboea and Parnassus. Thus, in discussing the effects of climate on timber destined *for the [building] carpenter's purposes* (*προς την τεκτονικὴν χρείαν*), Theophrastus grades the timber of Euboea and Parnassus as the worst, compared to the timbers of more northerly regions, *for it is full of knots and rough and quickly rots* (*Historia Plantarum* 5.2.1); even though, in this passage, Theophrastus refers to timber in general, he has the fir tree in mind, as becomes evident from Pliny, who draws on Theophrastus (Meiggs 1982, 22ff.; Ulrich 2007, 239) and writes about the firs that *[t]hose of Parnassus and Euboea are the worst of all, the trees being branchy and knotted, and the wood very apt to rot* (*Natural*

⁶⁰ G. Mantanis, pers. comm.

⁶¹ G. Mantanis, pers. comm.

⁶² Farjon 2010, 27; Voulgarides 2015, 172; G. Mantanis, pers. comm.

⁶³ G. Mantanis, pers. comm.

⁶⁴ Vitruvius further specifies that while the lowest part of the fir, closest to the ground, is ‘clear’ of knots, the upper part, which contains many branches, *when it is cut off about twenty feet from the ground and then hewn, is called "knotwood" because of its hardness and knottiness* (*De architectura* 2.9.7).

History 16.76) (Pliny arbitrarily changes Theophrastus' description of the second-quality (fir) trees of Parnassus and Euboea from 'knotty and rough' to 'knotty and twisted') (Meiggs 1982, 26, 43, 211, 353).

If Greek fir were to be used in the LK-T building, based on present-day data, it would have had to be felled in the deep forests of Mount Dirphys, in central Euboea (Fig. A2:1), such as the forest of Steni, which is the closest to Lefkandi and, moreover, the place where one of the two main branches of the Lelas River takes its source (Fig. A2:2)⁶⁵ – it is indeed expected that felling would have been concentrated on forests near the river;⁶⁶ the logs could have been hauled down the mountainside or perhaps carried down by yokes of oxen (or mules) via footpaths to the river, then made into rafts⁶⁷ to be sent downstream in autumn-winter⁶⁸ or spring, when the river is abundant with water and when the logs should have been felled (see main text), all the way to the Lefkandi region.^{69 70}

However, Euboean Fir stands few chances to have been used in the LK-T building, because of the low quality of its wood. Given the difficulties in obtaining Black pine and Aleppo pine from the northern part of Euboea (*supra*), Fir would have come only as a second choice after Cypress: why go to the trouble of transporting low-quality Fir from the high mountains, if Cypress was available locally, from the coast to higher elevations, and perhaps in greater density during ancient times?



Fig. A2:2. Hydrological basin and hydrographic network of the Lelas River (adapted with kind permission from Katetsiadou 2011, map 12).

⁶⁵ Katetsiadou 2011, 22-3, maps 11, 12, 22, 26. The part of the river near Steni, which is classified as Class 3 of the Strahler stream order (Fig. A2:2), would have been able to carry the logs during the winter months (K.-N. Katetsiadou, pers. comm.).

⁶⁶ Cf. the expectation that logging in the Tiber basin would have been mainly concentrated on areas close to the Tiber itself (Meiggs 1982, 245).

⁶⁷ Rafting would have been preferred to the simpler method of floating the timber downstream, because of the winding course of the Lelas River; rafting was sometimes preferred even on wide, fast-flowing rivers, conducive to timber floating (Meiggs 1982, 336-7).

⁶⁸ Cf. the image of a mountain torrent, swollen by winter rain, that floods across the plain, bearing dead oaks and pines to the sea in Homer (*Iliad* 11.494) (see also Meiggs 1982, 112).

⁶⁹ For the transport of timber via rivers in antiquity, see Meiggs 1982, 125, 141, 243, 245, 334-9; Ulrich 2007, 242, 254, 266-7.

⁷⁰ In Central Euboea, besides Mount Dirphys, there are forests of *Abies cephalonica* on Mount Skoteini and on Mount Mavrovouni, respectively east and northeast of Mount Dirphys (Kouvara 2019, 47), which are further away from the Lelas River, as well as on Mount Olympos, which is closer to Lefkandi, at a distance of c. 16 km to the northeast, in a straight line (Fig. A2:1). However, in the latter case, the logs would have had to be hauled by oxen teams (or mules) all the way to Lefkandi and these transport difficulties might have been a strong deterrent if the timber could be easily transported by river. In antiquity, water transport (via rivers or by sea) was preferred to land transport, the latter being much more cumbersome and expensive (Meiggs 1982, 209, 341-2).

II. TAPER AND UPPER DIAMETER OF CENTRE POSTS IN THE LK-T BUILDING

by Dimitrios Raptis

We will attempt to estimate the taper and therefore the upper diameter of the centre post (C1) with the minimum lower diameter (at floor level) of the (surviving) centre posts, 0.20 m, that of a centre post with a lower diameter (at floor level) equal to the average diameter (at floor level) of the (surviving) centre posts, 0.22 m (see Table A3:1), assuming an above-ground height of 8.58 m for the centre posts, based on the reconstruction of the building proposed here (main article, Fig. 7). Additionally, to address Herdt's argument and for purely theoretical purposes, we will try to estimate the taper and upper diameter of a hypothetical centre post with a lower diameter at floor level equal to 0.18 m; this last value is the diameter recorded for C4, but in reality it does not represent the base diameter of this post at ground level but a diameter at a depth of 0.80 m from ground level (see Introduction).

The taper of a tree trunk, i.e. the amount by which the diameter of a tree trunk decreases with height, depends on whether it is a tree or 'individual' grown in the open (an 'open grown tree') or as part of a forest or 'closed' cluster – in the latter case, the trees, being closer together and competing for space, light and nutrients with other individuals, rising skyward, grow taller, more slender and straighter, and present a less pronounced taper – but also and, most importantly, on the tree species, as well as on the structure, topography, and soil conditions of a forest.

The relevant taper studies available

Concerning the taper of each of the four species of conifers, present nowadays on Euboea, that can be considered as candidates for the centre posts of the LK-T building (*supra*), the following studies are available. For the Mediterranean Cypress, there is a limited study of *Cupressus sempervirens* var. *horizontalis* putting forward a height-diameter model (Raptis, in preparation). For the Black pine, there are two extensive studies of *Pinus nigra* Arn. putting forward, respectively, a height-diameter model that predicts the height of the tree based on its diameter at breast height (DBH) (Raptis et al. 2021), and a taper model that predicts the reduction factor of the tree diameter (taper) (Özçelik et al. 2016).⁷¹ There is also a model for the prediction of the thickness of the bark of *Pinus nigra* (Sevci et al. 2016), as this species has a thicker bark (compared to Cypress and Greek Fir, whose bark is very thin and therefore of negligible size) and the thickness of its bark changes with height. Finally, for the Greek Fir, there is an old study by Svarnas (1961), which simply considers the diameter reduction factor in cm/m, without the use of any mathematical equation.⁷²

Regarding the diameter reduction (taper) equations, in general, the following remarks are in order:

(1) they change from species to species; (2) they determine the diameter of the trunk at different heights; as an introductory element, they use the diameter at breast height (DBH), 1.30 m above ground level, of a living (standing) individual (tree); and (3) they refer to individuals growing in competitive conditions (in a forest or cluster) rather than to free-growing individuals (open grown trees).

Estimates of upper diameters of centre posts in the LK-T building

Based on the above-mentioned taper studies on the Mediterranean Cypress, the Black pine and the Greek Fir, we can now estimate, for each of these three species, the upper diameter of centre posts with lower diameters (at floor level) of 0.18 m (hypothetical), 0.20 m, and 0.22 m (*supra*), assuming that they were debarked logs rising 8.58 m above the floor, i.e. above their buried part, which is on average 1.44 m (Table A3:1); since 1.44 m is very close to the standard DBH of a tree, we can use the diameter of their base, at floor level, with minimal deviation. Given the absence of studies on the taper of the Aleppo pine, *Pinus halepensis*, and in particular of

⁷¹ Note that the height-diameter models explain about 90% of height variation, while the taper models explain about 98%.

⁷² Svarnas 1961, cited in Matis 2004, 95-6. This is a study of 3.496 fir trees from the area of Pertouli (Pindos Mountains), giving a diameter reduction factor with a mean value of 1.47 cm/m (min.= 0.34 cm/m, max. = 1.91 cm/m) (M. Diamantopoulou, pers. comm.; D. Zianis, pers. comm.).

the type that is characteristic of northern Euboea, we cannot provide estimates for this type of tree, if one is to assume that it was used in the LK-T building.

Mediterranean Cypress, *Cupressus sempervirens*

If Cypress was used for the centre posts of the LK-T building, one can estimate, based on the model available, the upper diameters of centre posts with a lower diameter of 0.18 m, 0.20 m and 0.22 m as follows.

First, based on a simple (mean) taper model of *Cupressus sempervirens* var. *horizontalis* (Fig. A2:3, green curve):

For trees with DBH = 0.18 m (total tree height = 14.31 m): upper diameter = 0.1078 m

For trees with DBH = 0.20 m (total tree height = 15.39 m): upper diameter = 0.1197 m

For trees with DBH = 0.22 (total tree height = 16.43 m): upper diameter = 0.1317m.

However, a model fitted to the tallest, say 5% (95th percentile), of *Cupressus sempervirens* var. *horizontalis* individuals, based on quantile regression (Fig. A2:3, red curve), gives the following results:

For trees with DBH = 0.18 m (total tree height = 18.28 m): upper diameter = 0.1269 m

For trees with DBH = 0.20 m (total tree height = 19.75 m): upper diameter = 0.141 m

For trees with DBH = 0.22 (total tree height = 21.01 m): upper diameter = 0.155 m.⁷³

Thus, to address Herdt's argument, whereas the simple (mean) taper model gives for the (hypothetical) centre post with a lower diameter of 0.18 m an upper diameter of only 0.1078 m, the model fitted to the tallest, say 5%, of cypress trees gives an upper diameter of 0.1269 m, which is larger than that estimated by Herdt. This is obviously because these taller trees grow in more fertile soil and in dense clusters with increased

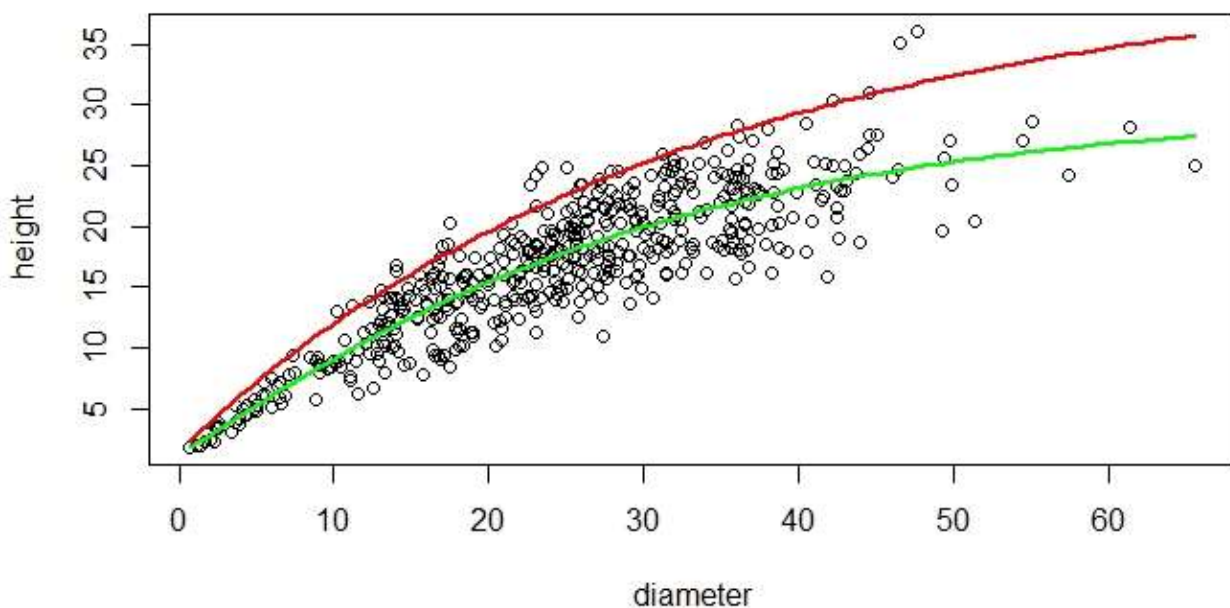


Fig. A2:3. Graphical representation of the mean (green line) and the maximum (red line) height curve against the diameter at 1.30m for *Cupressus sempervirens* var. *horizontalis*.

competition for light. And it is of course natural that at a height of 8.58 m above the DBH, these taller trees are thicker, because otherwise they would break from the wind (greater stress) even in forest conditions. So, if the carpenters of the LK-T building used Cypress, they could, quite simply, have chosen only few of the standing cypress trees, those that met their 'specifications', that is to say the tallest of the species, which offered a wider diameter at the top to support the ridge beam(s).

⁷³ This calculation is based on a height-diameter model (Raptis et al., in preparation). Note that, even though one presumes that the centre posts of the LK-T building were made of debarked logs, in all the above calculations, the bark has been included, because the Cypress bark is very thin and there is no relevant model predicting the thickness of the bark in this species. Also note that in the calculations based on a model fitted to the tallest 5% (95th percentile) of individuals, only those concerning the DBH of 0.22 m have been confirmed in the field (the others are approximate) and that the 5% of the tallest trees was chosen randomly.

Black pine, Pinus nigra

If one is to assume the use of Black pine for the centre posts of the LK-T building, based on the models available, one can estimate the upper diameters of centre posts with a lower diameter of 0.18 m, 0.20 m and 0.22 m as follows.

First, based on the simple (mean) taper model of *Pinus nigra* Arn.:

For trees with DBH = 0.18 m (total tree height = 15.46 m): upper diameter = 0.112 m

For trees with DBH = 0.20 m (total tree height = 16.28m): upper diameter = 0.136 m

For trees with DBH = 0.22 m (total tree height = 16.96 m): upper diameter = 0.154 m.⁷⁴

However, a model fitted to the tallest 5% (95th percentile) of *Pinus nigra* Arn. individuals based on quantile regression, gives the following results:

For trees with DBH = 0.18 m (total tree height = 20.20 m): upper diameter = 0.1316 m

For trees with DBH = 0.20 m (total tree height = 20.86 m): upper diameter = 0.155 m

For trees with DBH = 0.22 m (total tree height = 21.60 m): upper diameter = 0.188 m.

Thus, to respond to Herdt's argument, whereas the simple (mean) taper model gives for the (hypothetical) centre post with a base diameter of 0.18 m, an upper diameter of 0.1121 m, a model fitted to the tallest 5% of individuals gives an upper diameter of 0.13 m, which is greater than that estimated by Herdt. The latter model shows that it is possible to have individuals of *Pinus nigra* Arn. growing in more fertile soil and in dense clusters under intense competitive conditions, with a DBH of 0.213 m (debarked DBH = 0.18 m) and a height of 20.20 m (as opposed to the height of 15.46 m given by the former model) and a diameter of 0.13 m at 8.58 m above the DBH. This is confirmed experimentally by the available data on the diameter reduction factor of *Pinus nigra* Arn. growing under competitive conditions (Raptis et al. 2021).^{75 76} As with Cypress, this shows the important role of soil fertility and conditions of increased competition for light, and makes it likely that, if the carpenters of the LK-T building used Black Pine, they would probably have selected

⁷⁴ This calculation is based on: (a) a height-diameter model of *Pinus nigra* Arn. (Raptis et al. 2021) combined with a model predicting the thickness of the bark in this species (Sevgi et al. 2016, 1352), since one presumes that the centre posts of the LK-T building were made of debarked logs and since the thickness of the Black pine bark is greater (compared to Cypress and Greek fir) and changes with height; and, subsequently, (b) a taper model of *Pinus nigra* Arn. (Özçelik et al. 2016). Thus, for instance, for a (hypothetical) centre post with a minimum lower diameter of 0.18 m, the original debarked log with a DBH (at 1.30 m from its base, very close to the average of 1.44 m of the buried part of the surviving center posts at LK-T, with little deviation) of 0.18 m can be estimated as having with its bark a DBH equal to 0.2137 m. For a DBH diameter of 0.2137 m, the mean model predicts a total tree height of 15.46 m and, in this individual, at a height of 8.58 m above the DBH, the barked diameter is equal to 0.1301 m, while the debarked diameter is equal to 0.1121 m.

⁷⁵ Among the dataset on the diameter reduction factor of 3.500 *Pinus nigra* Arn. growing in the Olympus National Park in Greece under competitive conditions (Raptis et al. 2021), there is indeed an individual (tree) with DBH equal to 0.213 m (cf. the DBH diameter of 0.2137 m, including the bark, predicted by the model for a presumably debarked (hypothetical) centre post with a base diameter of 0.18 m above a buried height of 1.4 m, which is very close to the DBH of 1.30 m) and a total height of 19 m. Its diameters, measured from the base upwards every 2 meters, are: 0 m: 0.242 m, 2 m: 0.201 m, 4 m: 0.179 m, 6 m: 0.161 m, 8 m: 0.149 m, 10 m: 0.138 m, 12 m: 0.115 m, 14 m: 0.089 m, 16 m: 0.054 m, 18 m: 0.028 m. The diameter of this individual without its bark at a height of 8 m can be estimated, based on the model predicting the thickness of the bark in this species (Sevgi et al. 2016, 1352), as equal to 0.1305 m, while even at a height of 10 m its diameter without the bark is estimated as equal to 0.121 m.

⁷⁶ One may also note, in this respect, the data of the specifications of the telephone and electric poles in Greece, which refer to various species of pines, including *Pinus nigra* (Voulgarides 2015, 154-60), and give the following values:

-Telephone poles:

H = 7.0 m; min. diameter at a height of 1.50 m from base = 0.18 m; upper diameter = 0.14-0.17 m.

H = 8.0 m; min. diameter at a height of 1.50 m from base = 0.19 m; upper diameter = 0.14-0.17 m.

H = 9.0 m; min. diameter at a height of 1.50 m from base = 0.19 m; upper diameter = 0.14-0.17 m.

H = 10.0 m; min. diameter at a height of 1.50 m from base = 0.20 m; upper diameter = 0.14-0.17 m.

(Voulgarides 2015, table 6.6).

-Electricity poles:

H = 9.0 m; min. diameter at a height of 1.80 m from base = 0.19-0.26 m; min. upper diameter = 0.12-0.18 m.

H = 10.0 m; min. diameter at a height of 1.80 m from base = 0.20-0.27 m; min. upper diameter = 0.12-0.18 m.

H = 11.0 m; min. diameter at a height of 1.80 m from base = 0.21-0.28 m; min. upper diameter = 0.12-0.18 m.

(Voulgarides 2015, table 6.7).

This shows that it is possible to find pine trees c.8.6 m high, with DBH of 0.18 m and an upper diameter of 0.14-0.17 m or higher.

only those individuals (trees) that were suitable for the job, that is the tallest of the species,⁷⁷ offering a larger upper diameter for the sitting of the ridge beam(s).

Greek Fir, Abies cephalonica

If Greek fir was used for the centre posts of the LK-T building, based on the old study by Svarnas (1961) cited above, one can make a rough estimate of the upper diameters of centre posts with a lower diameter of 0.18 m, 0.20 m and 0.22 m as follows.⁷⁸

First, based on the mean diameter reduction factor:⁷⁹

For trees with DBH = 0.18 m: upper diameter = 0.0538 m

For trees with DBH = 0.20 m: upper diameter = 0.0738 m

For trees with DBH = 0.22 m: upper diameter = 0.0938 m.⁸⁰

However, based on the minimum diameter reduction factor,⁸¹ which results from individuals (trees) growing in more fertile soils, one obtains:

For trees with DBH = 0.18 m: upper diameter = 0.1508 m

For trees with DBH = 0.20 m: upper diameter = 0.1708 m

For trees with DBH = 0.22 m: upper diameter = 0.1908 m.⁸²

Thus, regarding Herdt's argument, whereas the mean diameter reduction factor gives an upper diameter of only 0.0538 m for a (hypothetical) centre post with a base diameter of 0.18 m, the minimum diameter reduction factor, which results from trees growing in more fertile soils, gives an upper diameter of 0.1508 m, which is much larger than that estimated by Herdt. Therefore, as with Cypress and Black pine, if the carpenters of the LK-T building used Greek fir, they are likely to have selected the tallest trees of this species.

CONCLUSIONS

There are four species of conifers present nowadays in Euboea that can be considered as candidates for the centre posts and, more generally, for the other long members of the timber frame and the roof of the LK-T building. These are: Mediterranean Cypress, Black pine, Aleppo pine of the type thriving in the northern part of the island, and Greek Fir.

The Mediterranean Cypress, the 'giant of Greek woods', by its size, its straightness, its excellent wood offering great resistance to fungi and insect attacks, and its aroma would have been the first choice for the LK-T building and given that it was probably available locally in greater density than today, it appears to be the most likely candidate. The Black Pine and the Aleppo Pine of northern Euboea, although providing long lengths of good-quality, straight timber, were probably not selected for the LK-T building, due to the distance involved and the challenges associated with transporting them from the mountains to the seaside and also

⁷⁷ In what appears to be the only existing study of Euboean conifers, pertaining to the Black pine in the forest of Limni, on Mount Xiron, Kouvara (2019) has shown the following.

Tree heights: average height = 13.11 m (pure stands of Black pine); maximum height = 29 m; the maximum number of trees clusters around the heights of 20-25 m (Kouvara 2019, 57, 66, 81). These figures are compatible with the total tree heights obtained by the two models used here.

Diameters at breast height (DBH): average diameter = 23.38 cm (pure stands of Black pine); maximum diameter = 50 cm; the maximum number of trees clusters around the diameters of 34-42 cm, the next cluster being 26-34 cm (Kouvara 2019, 56, 63-4). These figures are compatible with the maximum lower diameters (or approximately the DBH) of the trees forming the centre posts C2 and C4 in the LK-T building, which are 25 cm and 30 cm, respectively (see Table A3:1); they are also compatible with the reconstructed tree diameters of 27.5-37 cm for the production of the wall- and veranda posts (main article, Fig. 13).

⁷⁸ In the following calculations, the bark is included, since the bark of the fir tree is very thin.

⁷⁹ Mean diameter reduction factor = 1.47 cm/m (Svarnas 1961, cited in Matis 2004, 95-6).

⁸⁰ Thus:

$$0.18 - (0.0147 \times 8.58) = 0.0538 \text{ m}$$

$$0.20 - (0.0147 \times 8.58) = 0.0738 \text{ m}$$

$$0.22 - (0.0147 \times 8.58) = 0.0938 \text{ m.}$$

⁸¹ Minimum diameter reduction factor = 0.34 cm/m (Svarnas 1961, cited in Matis 2004, 95-6).

⁸² Thus:

$$0.18 - (0.0034 \times 8.58) = 0.1508 \text{ m}$$

$$0.20 - (0.0034 \times 8.58) = 0.1708 \text{ m}$$

$$0.22 - (0.0034 \times 8.58) = 0.1908 \text{ m.}$$

through the Euripus Strait. Finally, the Greek fir has little chance of having been used in the building, because even if it provided very long and straight timbers, its wood was already known in antiquity to be of inferior quality; in addition, it would have to be transported to the site from the high altitudes of Mount Dirphys, via the Lelas River. So, if one were to completely rule out Black pine and Aleppo pine from northern Euboea, Greek fir would only be the second choice after Cypress for the LK-T carpenters, since one expects that they would not have gone into the trouble of transporting poor quality fir from the high mountains, if there were valuable cypress trees in their own land.

Based on the taper studies available to us for the Mediterranean Cypress, Black pine, and Greek fir, we can reasonably assume that, if the carpenters of the LK-T building used one of these three species, they would have selected the tallest trees. In this case, the upper diameter of a (hypothetical) centre post with a lower diameter of 0.18 m can be estimated, respectively for each of the above mentioned species, as equal to 0.1269 m, 0.1316 m and 0.1508 m, values which are higher than that estimated by Herdt, while the upper diameter of the centre post (C1) with the minimum lower diameter of 0.20 m can be estimated, respectively for each of the above mentioned species, as equal to 0.141 m, 0.155 m and 0.1708 m, making it capable of supporting a ridge beam with a width of 0.112m, as reconstructed here.

REFERENCES

- A Handbook of Softwoods* 1977. Building Research Establishment, 2nd edn (London).
- Alizoti, P.G., Fady, B., Prada, M.A. and Vendramin, G.G. 2011. *EUFORGEN Technical Guidelines for genetic conservation and use for Mediterranean firs (Abies spp.)* (Rome).
- Asensi Amorós, M.V. 2016. ‘The history of conifers in Egypt, part I: Mediterranean cypress (*Cupressus sempervirens* L., Cupressaceae)’, in Thanheiser, U. (ed.), *News from the past: Progress in African archaeobotany: Proceedings of the 7th International Workshop on African Archaeobotany in Vienna, 2-5 July 2012* (Groningen), 3-11.
- As, N., Goker, Y. and Dundar, T. 2006. ‘Effect of knots on the physical and mechanical properties of Scots pine (*Pinus sylvestris* L.)’, *Wood research* 51.3, 51-58.
- Bektaş, I. and Kurt, R. 2010. ‘Principal Mechanical Properties of Cypress Wood (*Cupressus Sempervirens* L.) Naturally Grown in (Kahramanmaraş) Eastern Mediterranean of Turkey’, *Gazi University Journal of Science* 23.3, 357-62.
- Boratynski, A., Browicz, K. and Zielinski, J. 1988. ‘Woody flora of Euboea (Evvoia)’, *Arboretum Kórnickie* 33, 13-74.
- Brofas, G., Karetos, G., Dimopoulos, P. and Tsagari, C. 2006. ‘The natural environment of *Cupressus Sempervirens* in Greece as a basis for its use in the Mediterranean region’, *Land Degradation & Development* 17, 645-59.
- BS EN 350, 2016, *Durability of wood and wood-based products – Testing and classification of the durability to biological agents of wood and wood-based materials* (London).
- Caudullo, G. and Tinner, W. 2016. *Abies – Circum-Mediterranean firs in Europe: distribution, habitat, usage and threats*, in J. San-Miguel-Ayanz, D. de Rigo, G. Caudullo, T. Houston Durrant and A. Mauri (eds), *European Atlas of Forest Tree Species* (Luxembourg), 50-51.
- Caudullo, G. and de Rigo, D. 2016. ‘*Cupressus sempervirens* in Europe: distribution, habitat, usage and threats’, in J. San-Miguel-Ayanz, D. de Rigo, G. Caudullo, T. Houston Durrant and A. Mauri (eds), *European Atlas of Forest Tree Species* (Luxembourg), 88-9.
- Chambel, M.R., Climent, J., Pichot, C. and Ducci, F. 2013. ‘Mediterranean Pines (*Pinus halepensis* Mill. and *brutia* Ten.), in L.E. Pâques (ed.), *Forest Tree Breeding in Europe: Current State-of-the-Art and Perspectives* (Dordrecht), 229-66.
- Crammond, P.C. 1999. *An Investigation of Aleppo Pine for Low Rainfall Farm Forestry*. Rural Industries Research and Development Corporation, Publication No 99/016 (Barton, Canberra).
- Daskalakou, E.N., Albanis, K., Skouteri, A. and Thanos, C.A. 2014. ‘Predicting time-windows for full recovery of postfire regenerating *Pinus halepensis* Mill. forests after a future wildfire’, *New Forests* 45, 53-70.
- Eginitis, D. 1929. ‘The problem of the tide of Euripus’, *Astronomische Nachrichten* 236.19, 321-8.
- Elaieb, M.T., Shel, F., Elouellani, S., Janah, T., Rahouti, M., Thévenon, M.-F. and Candelier, K. 2017. ‘Physical, mechanical and natural durability properties of wood from reforestation *Pinus halepensis* Mill. in the Mediterranean Basin’, *Bois et Forêts des Tropiques* 331.1, 19-31.
- Eleutheriadou, E. and Theodoropoulos, K. 2001. *Η ξυλώδης χλωρίδα της νήσου Ευβοίας. Δυνατότητες αξιοποίησης και προστασία της*, Laboratory of Forest Botany – Geobotany, School of Forestry and Natural Environment, Aristotle University of Thessaloniki (available online < <https://dokumen.tips/documents/-5465db0bb4af9ff3478b4e52.html?page=1> > accessed September 2023).
- Enescu, C.M., de Rigo, D., Caudullo, G., Mauri, A., and Houston Durrant, T. 2016. ‘*Pinus nigra* in Europe: distribution, habitat, usage and threats’, in J. San-Miguel-Ayanz, D. de Rigo, G. Caudullo, T. Houston Durrant and A. Mauri (eds), *European Atlas of Forest Tree Species* (Luxembourg), 126-7.
- Farjon, A. 2010. *A Handbook of the World's Conifers* (Leiden).
- Fioravanti, M. and Caramiello, R. 1999. ‘Il legno e la sua lavorazione’, in A. Ciarallo and E. De Carolis (eds), *Homo faber: natura, scienza e tecnica nell'antica Pompei* (Milan), 85-6.
- Flood, M.T. 2019. *Elemental Analysis of Species Specific Wood Ash: A Pyrogenic Factor in Soil Formation and Forest Succession for a Mixed Hardwood Forest of Northern New Jersey* (unpublished thesis, Montclair State University).

- Göker, Y. and As, N. 1990. 'The modulus of elasticity in bending of the wood of *Cupressus sempervirens* var. *horizontalis*', *İstanbul Üniversitesi Orman Fakültesi Dergisi*, Series A, 40.1, 28-39.
- Herd, G. 2015. 'On the Architecture of the Toumba Building at Lefkandi', *BSA* 110, 203-12.
- Hort, A. (Sir-) 1916. *Theophrastus: Enquiry into Plants, and Minor Works on Odours and Weather Signs* (London).
- Isajev, V., Fady, B., Semerci, H. and V. Andonovski, V. 2004. *EUFORGEN Technical Guidelines for genetic conservation and use for European black pine (Pinus nigra)* (Rome).
- Kakaras, I. 2013. *Τεχνολογία ξύλινων δομικών κατασκευών* (Athens).
- Kalimi, I. 2018. *Writing and Rewriting the Story of Solomon in Ancient Israel* (Cambridge).
- Katsesiadou, A.-N. 2011. *Μελέτη Κινδύνου από Φυσικές Καταστροφές – Δήμος Χαλκιδέων* (unpublished thesis, University of Athens).
- Kouvara, E. 2019. *Ανάλυση δομής και συνθήκες αναγέννησης σε συστάδες Μαύρης πεύκης σε δάση της Εύβοιας* (unpublished thesis, Aristotle University of Thessaloniki).
- Krokene, P. 2015. 'Conifer Defense and Resistance to Bark Beetles', in R. W. Hofstetter and F. E. Vega (eds), *Bark beetles: biology and ecology of native and invasive species* (Amsterdam), 177-207.
- Mantanis, G. I. 2019. *Αναγνώριση ξύλου (προέλευση, ονοματολογία, ταυτοποίηση)* (Karditsa).
- Matis, K. 2004. *Δασική Βιομετρία II. Δεντρομετρία* (Thessaloniki).
- Mauri, A., Di Leo, M., de Rigo, D., Caudullo, G. 2016. '*Pinus halepensis* and *Pinus brutia* in Europe: distribution, habitat, usage and threats', in J. San-Miguel-Ayanz, D. de Rigo, G. Caudullo, T. Houston Durrant and A. Mauri (eds), *European Atlas of Forest Tree Species* (Luxembourg), 122-3.
- Meiggs, R. 1982. *Trees and timber in the ancient Mediterranean world* (Oxford).
- Nocetti, M., Della Rocca, G., Berti, S., Brunetti, M., Di Lonardo, V., Danti, R. 2015. 'Genetic growth parameters and morphological traits of canker-resistant cypress clones selected for timber production', *Tree Genetics & Genomes* 11, 73.
- Özçelik, R., Karatepe, Y., Gürlevik, N., Cañellas, I., Crecente-Campo, F. 2016. 'Development of ecoregion-based merchantable volume systems for *Pinus brutia* Ten. and *Pinus nigra* Arnold. in southern Turkey', *Journal of Forestry Research* 27.1, 101-17.
- Papadima, A.A. 2014. *Γενετική ανάλυση σποροπαραγωγού κήπου Χαλεπίου πεύκης (Pinus halepensis Mill.)* (unpublished PhD thesis, Aristotle University of Thessaloniki).
- Papageorgiou, A.C., Panetsos, K.P., Hattemer, H.H. 1994. 'Genetic differentiation of natural Mediterranean cypress (*Cupressus sempervirens* L.) in Greece', *Forest Genetics* 1, 1-12.
- Papageorgiou, A.C., Finkeldey, R., Hattemer, H.H. and Xenopoulos, S. 2005. 'Genetic differences between autochthonous and breeding populations of common cypress (*Cupressus sempervirens* L.) in Greece', *European Journal of Forest Research* 124, 119-24.
- Paraskeuopoulou, A. 1987. *Διακύμανση των δομικών χαρακτήρων του ξύλου του κυπαρισσιού (Cupressus sempervirens L.) στην Ελλάδα* (unpublished PhD thesis, University of Athens).
- Passialis, C. and Kiriazakos, A. 2004. 'Juvenile and mature wood properties of naturally-grown fir trees', *Holz Roh Werkst* 62, 476-8.
- Popham, M.R., Calligas, P.G., and Sackett, L.H. (eds), 1993. *Lefkandi II. The Protogeometric Building at Toumba. Part 2: The Excavation, Architecture and Finds* (London).
- Raptis, D.I., Kazana, V., Kazaklis, A. and Stamatiou C. 2012. 'Mixed-effects height-diameter models for black pine (*Pinus nigra* Arn.) forest management', *Trees* 35, 1167-83.
- Raptis, D.I., Kazana, V., Stamatiou, C., Papadopoulou, D. and Psarra, A. (forthcoming), 'Allometric management models for Mediterranean cypress (*Cupressus sempervirens* L. var. *horizontalis*) in urban and peri-urban forest ecosystems', *Journal of Sustainable Forestry*.
- Richards, P. 1996. *Fighting for the rain forest: War, Youth & Resources in Sierra Leone* (London).
- Rousodimos, G. 1997. *Φυσικές και μηχανικές ιδιότητες του ξύλου των ελληνικών δασοπονικών ειδών* (Athens).
- Seeley, I.H. 1980. *Building Technology* (Houndmills and London).
- Sevgi, O., Tecimen, H.B., Carus, S., Akburak, S. and Çakşir, E. 2016. 'Some bark characteristics of Black Pine (*Pinus nigra* arnold.) and their variation throughout the tree height', *Journal of Environmental Biology* 37.6, 1347-54.
- Sobon, J. and Schroeder, R. 1984. *Timber frame construction: all about post-and-beam building* (Pownal, Vt.).
- Spanos, K., Gaitanis, D. and Spanos, I. 2010. 'Resin production in natural Aleppo pine stands in northern Evia, Greece', *Web Ecology* 10, 38-43.
- Svarnas, D.K. 1961. *Συμβολή εις την έρευναν μεταβολής του μορφοδείκτου κορμοτεμαχίου της Abies Cephalonica Laud et Lk. Συναρτήσσει της μέσης διαμέτρου* (Thessaloniki).
- Ulrich, R.B. 2007. *Roman woodworking* (New Haven).
- Wagner Weick, C., Aamir, N. and Reichart, J. 2023. 'The Ethnobotanical Evolution of the Mediterranean Cypress (*Cupressus sempervirens*)', *Economic Botany*, 77.2, 203-21.
- Wood Handbook: Wood as an Engineering Material*, 2010. U.S. D. A., Forest Service, General Technical Report FPL-GTR-190 (Madison, WI).
- Villarino, A., López-Rebollo, J. and Antón, N. 2020. 'Analysis of Mechanical Behavior through Digital Image Correlation and Reliability of *Pinus halepensis* Mill.', *Forests* 11, 1232.
- Voulgarides, H.B. 2015. *Ποιότητα και χρήσεις του ξύλου* (Athens).
- Wilson Jones, M. and Herdt, G. 2022. 'Virtual Collapse? Considerations of Structure in Reconstructing Greek Architecture' in Borbonus, D. and Dumser, E. A. (eds), *Building the Classical World* (Oxford), 189-217.
- Zwenger, K. 2015. *Wood and Wood Joints. Building Traditions of Europe, Japan and China* (Basel).

Table A2:1. Types of conifer trees on Euboea

Species Common name/ Latin name	Tree height (max.)	Natural durability ¹	Density (gr/cm ³) ²	Hardness (radial) (N) ³	Compression strength (parallel to grain) (N/mm ²) ⁴	Compression strength (perpendicular to grain) (N/mm ²) ⁵	Bending strength (Modulus of rupture/MOR) (N/mm ²) ⁶	Modulus of elasticity (MOE) (N/mm ²)	Shear strength (N/mm ²) ⁷
Mediterranean cypress/ <i>Cupressus sempervirens</i>	30.50+ m	Very durable (class 1)	0.531	3,468	54.6	14.3	99.7	6,051.68– 8,080.68 ⁸	15.3
Black pine/ <i>Pinus nigra</i>	30.40 m	Slightly durable (class 4)	0.504	2,210	44.6	7.0	86.3	8,549.49– 10,810 ⁹	15.1
Aleppo pine/ <i>Pinus halepensis</i>	15–20 m (but in northern Euboea: 25–32 m)	Slightly durable (class 4)	0.571	3,748	49.8	11.8	104.0	9,950– 14,500 ¹⁰	12.9
Greek fir/ <i>Abies cephalonica</i>	30–35 m	Slightly durable (class 4)	0.401	1,789	39.5	5.4	76.1	8,106– 8,544 ¹¹	11.0

¹ Classes of natural durability of wood to fungal decay:

Durability class	Designation	Approximate timber life (years)
1	Very durable	25+
2	Durable	15-25
3	Moderately durable	10-15
4	Slightly durable	5-10
5	Not durable	0-5

Sources: BS EN 350, 2016; *A Handbook of Softwoods*, 6, where Class 4 is designated as ‘Non-durable’ and Class 5 as ‘Perishable’. The average life stated for each class relates to wood material of 5.08 x 5.08 cm cross-section, in contact with the ground; larger sizes are expected to last longer, with the increase depending on the wood species (*A Handbook of Softwoods*, 6).

² Rousodimos 1997.

³ Rousodimos 1997.

⁴ Rousodimos 1997.

⁵ Rousodimos 1997.

⁶ Rousodimos 1997.

⁷ Rousodimos 1997.

⁸ Göker and As 1990, table 1 (where the MOE for *Cupressus sempervirens* var. *horizontalis* is given as 61709 kp/cm², i.e. 6,051.68 N/mm², and the MOE for *Cupressus sempervirens* var. *pyramidalis* is given as 82400 kp/cm², i.e. 8,080.68 N/mm²).

⁹ <https://forestry.com/lumber/austrian-pine-lumber/>; <https://www.wood-database.com/austrian-pine/>

¹⁰ Villarino et al. 2020, 2, 12 with further references.

¹¹ But for *Abies cephalonica* x *Abies alba*, *Populus hybridogenous* (Passialis and Kiriazakos 2004, table 2).

APPENDIX 3 BUILDING DIMENSIONS AND TIMBER FRAME CONSTRUCTION DETAILS

by Alexandra Coucouzeli

I. UNIT OF LENGTH

All dimensions shown in the reconstruction of the LK-T building are multiples or subdivisions of a foot of 0.30 m, a plausible local unit of length, based on the ideal 3-metre interval between centre posts (main article, Fig. 5). The subdivisions of this unit of length would be: 1 foot = 16 fingers of 0.01875 m each; 1 foot = 4 palms of 0.075 m each. More analytically:

Palms	Fingers	Meters
	1	0.01875
	2	0.0375
	3	0.05625
1	4	0.075
	5	0.09375
	6	0.1125
	7	0.131
2	8	0.15
	9	0.1685
	10	0.1875
	11	0.20625
3	12	0.225
	13	0.243
	14	0.2625
	15	0.28125
4	16	0.30

II. BUILDING DIMENSIONS¹

Meters	Feet	Palms	Fingers
48.30	161		
46.80	156		
34.50	115		
26.85	89	2	
25.9875	86		10
23.25	77	2	
18.00	60		
14.40	48		
13.80	46		
11.38125	37		15
11.15625	37		3
10.80	36		
10.650	35	2	
10.20	34		
9.30	31		
9.15	30	2	
9.00	30		

¹ Only dimensions larger than the assumed foot and its subdivisions are listed. All dimensions are shown in mm on the drawings.

8.79375	29		5
8.7375	29		2
8.5875	28		10
8.55	28	2	
8.531	28		7
8.40	28		
7.70625	25		11
6.450	21	2	
6.1685	20		9
5.981	19		15
5.40	18		
5.175	17	1	
4.9875	16		10
4.7625	15		14
4.725	15	3	
4.70625	15		11
4.650	15	2	
4.575	15	1	
4.5375	15		2
4.51875	15		1
4.50	15		
4.35	14	2	
4.331	14		7
4.275	14	1	
4.21875	14		1
4.20	14		
3.75	12	2	
3.356	11		3
3.375	11	1	
3.35625	11		3
3.225	10	3	
3.1875	10		10
3.131	10		7
3.00	10		
2.925	9	3	
2.8685	9		9
2.8125	9		6
2.68125	8		15
2.5875	8		10
2.550	8	2	
2.475	8	1	
2.40	8		
2.3625	7		14
2.30625	7		11
2.175	7	1	
2.15625	7		3
2.1375	7		2
2.10	7		
1.950	6	2	
1.9125	6		6
1.80	6		
1.6875	5		10
1.575	5	1	

1.55625	5		3
1.50	5		
1.4625	4		14
1.443	4		13
1.35	4	2	
1.10625	3		11
0.9375	3		2
0.90	3		
0.60	2		
0.58125	1		15
0.543	1		13
0.525	1	3	
0.50	1		11
0.4875	1		10
0.45	1	2	
0.3375	1		2

III. TIMBER DIMENSIONS

Centre posts

Average lower diameter (at ground level): 0.22 m (or 0.225=3 palms) (Table A3:1). Average upper diameter (at a height of 8.58 m): 0.15 m (2 palms) as estimated for a log of a tall *Cupressus sempervirens* with a diameter of 0.22 m at breast height (DBH) of 1.30 m, which is very close to the average buried height of 1.4 m of the centre posts (Table A3:1; Appendix 2: II).

'Triptych' centre post (C11)

Lower diameter (at ground level): 0.25 m (Popham et al. 1993, table 2). Upper diameter (at a height of 7.71 m): 0.184 m.²

Wall- and veranda posts

Idealised cross-section: 0.075 m x 0.225 m (1 palm/4 fingers x 3 palms).³ The thin, plank-like cross-section of the wall- and veranda posts is reminiscent of planks (*sanides*) mentioned in ancient Greek texts and measuring 6 fingers x 3 palms (Hodge 1960, 123).

Plates on top of the wall- and veranda posts

Cross-section: 0.075 m x 0.150 m (1 palm x 2 palms/½ foot); placed 'on edge', i.e. vertically, rather than 'flat', thereby taking full advantage of their strength.⁴ Width = 0.075 m, like the idealised width of the wall- and veranda posts (*supra*), which is well within traditional plate widths of 0.05-0.075 m; depth = 0.150 m, which is double the width.⁵ The lengths of the plates would have varied between a minimum of 0.90 m and maximums of 8.5 m – 10.65 m⁶ (main article, Fig. 4). At the west end of the apse, curved plates of the same cross-section may have been used over the wall- and veranda posts.

² This is based on the estimate of the upper diameter of 0.1762 m at a height of 8.58 m of the log of a tall *Cupressus sempervirens* with a diameter of 0.25 m at breast height (DBH) of 1.30 m, which is very close to the average buried height of 1.4 m of the centre posts (D. Raptis, pers. comm.; Appendix 2: II; Table A3:1).

³ This is based on the average cross-section of 0.072 m x 0.22 m (see Table A3:1), converted to the nearest subdivisions of the assumed local unit of length.

⁴ Indeed, 'the strength of a beam lies in its depth' (Hodge 1960, 92; Harris 1979, 18).

⁵ †A. Baggs, pers. comm.; Smith 1983, Series 1, Sheet Nos. 53-58: modern plates: 0.10 x 0.075 m or 0.10 x 0.05 m.

⁶ Cf. Sobon and Schroeder 1984, 23, citing c.9 m long plates over the tops of posts in old barns.

Plates on top of posts in ‘triptych’-like structure of AR

Cross-section: 0.112 m x 0.150 m (6 fingers x 2 palms/½ foot);⁷ placed ‘on edge’.

Plates on top of studs of partition across the ER

Cross-section: 0.112 m x 0.150 m (6 fingers x 2 palms/½ foot), like the plates on top of the posts of the ‘triptych’-like structure in the Apse Room; placed ‘on edge’.

Ridge beams

Over the 18 m long span between centre posts C4 and C9a, two ridge beams with a cross-section of 0.10 m x 0.20 m can be reconstructed, each 9 m long for safety reasons, supported by four centre posts at 3 m-intervals (3 m long ridge beams are to be excluded as too short).⁸ Cross-section: 0.112 m x 0.206 m (6 fingers x 11 fingers).⁹ The ridge beams would have been placed ‘on edge’.

Rafters

Apart from the ‘principal’ rafters over the wall- and veranda posts, ‘intermediate’ or ‘common rafters’ of the same dimensions as the ‘principal’ rafters must have existed, given that the wall- and veranda posts intervals vary between *c.*1.40 m – *c.*2.25 m (with only a few exceptions of intervals being smaller than *c.*1.40 m) and are therefore larger than the intervals of 0.40-0.60 m normally used between rafters in construction today¹⁰ or the 0.40 to 0.75 m intervals recommended for rafter spacing in thatched roofs.¹¹

Spacing of ‘principal’ and ‘common’ rafters

In view of what has been mentioned above about the intervals recommended for rafter spacing and based on the reasonable assumption that as few additional rafters as possible would be preferred at LK-T, in view of their great length over an effective span of *c.*6.2 m (slope distance at 45° from ridge beam to plate over wall posts) and particularly if these were squared timbers, as suggested here, implying greater labour investment,¹² one can reconstruct in the part of the building up to the hipped roof over the west half of the apse:

- Two ‘common’ rafters between ‘principal’ rafters in most cases, spaced at *c.*0.50 m (1 foot 11 fingers) from each other in the typical 1.50 m interval between ‘principal’ rafters (main article, Fig. 5) and at *c.*0.60 m (2 feet) from each other in, for instance, an interval of *c.*1.80 m (main article, Fig. 6: Insets B and D).
- In, for instance, an interval of *c.*1.35 m-1.40 m: either two ‘common’ rafters between ‘principal’ rafters at *c.*0.45 m (1 foot 2 palms/½ foot) from each other or one ‘common’ rafter between ‘principal’ rafters at *c.*0.70 m from each other.
- In the exceptionally large first set of intervals from the east (VN1-VN2, N1-N2, S1-S2, VS1-VS2) of *c.*2 m-2.25m: three ‘common’ rafters between ‘principal’ rafters at *c.*0.50 m – 0.56 m (1 foot 11 fingers – 1 foot 14 fingers).
- In the small intervals between *c.*0.70 m – 1.34 m: one ‘common’ rafter between ‘principal’ rafters, placed at the midpoint of the interval, resulting in intervals between *c.*0.35 m – 0.67 m.

In the hipped roof over the west half of the apse, one can reconstruct 1-2 ‘common’ rafters between ‘principal’ rafters, with intervals varying between *c.*0.26 m – *c.*0.70 m, depending on the width of the interval between ‘principal’ rafters (main article, Fig. 6: Inset A).

⁷ The thickness 0.112 m is based on the calculation of the thickness of the cranked timbers of the ‘triptych’-like structure (between T1 and T2 and between T5 and T6 – main article, Fig. 6: Insets A and B) as *c.*0.10 m (to allow enough space for their superincumbent rafters) converted to the nearest subdivisions of the assumed local unit of length. The depth of 0.150 m is the same as the reconstructed depth of the plates resting on the wall- and veranda posts.

⁸ R. M. Foster, pers. comm.

⁹ This is based on the calculation of the cross-section of the ridge beams as equal to 0.10 m x 0.20 m, converted to the nearest subdivisions of the assumed local unit of length.

¹⁰ *The Building Regulations 1976*, table 23.

¹¹ *The Thatcher’s Craft*, 214, where 0.40 m intervals are recommended for roofs thatched with water reed; Hall 1988, 10, where 0.75 m intervals are recommended for thatched roofs, in general.

¹² R. M. Foster, pers. comm.

Cross-section: 0.075 m x 0.150 m (same cross-section as that of the plates over wall- and veranda posts – *supra*),^{13 14} placed ‘on edge’.

Battens

Twin battens of reed, diameter = 0.025 m each, fixed on the rafters at 0.30 m c/c (main article, Fig. 7).¹⁵

Crossbeams

Cross-section: 0.225 m x 0.30 m (3 palms x 1 foot), placed ‘on edge’. The width 0.225 m results from the fact that the central post of the stud partition across the middle of the ER, which supported the loft over the ER and the Porch along with the two crossbeams at either end of the loft, is situated midway between a line tangent to the centre post C1 and a line distant 0.22 m to the west of the midline of the partition wall between ER-CR, suggesting that the crossbeam in the area of this wall would be 0.22 m wide supporting a king post (K1) 0.22 m in diameter (Appendix 4: II, Fig. A4:3; main article, Fig. 10); the width 0.22 m for this crossbeam, which would have also supported the western ends of the floor joists in the loft, converted to the assumed local unit of length is 0.225 m (3 palms), and the same width can then be reconstructed for the other two crossbeams. This cross-section is a reasonable dimension for the crossbeam.¹⁶

The ends of crossbeams would have rested on the plates above the wall posts.

Diagonal braces under crossbeams

Cross-section: 0.112 m x 0.30 m (6 fingers x 1 foot).¹⁷

Joists

Joists in loft above the ER and the Porch

Cross-section: 0.075 m x 0.225 (1 palm x 3 palms); at 400 mm c/c,¹⁸ placed ‘on edge’ (main article, Fig. 8).

Joists in mezzanine above the SRs

Cross-section: 0.056 m x 0.187 mm (3 fingers x 10 fingers); at 400 mm c/c,¹⁹ placed ‘on edge’.

Ledge²⁰ fixed on inside face of wall posts

Ledge for supporting the floor joists of the mezzanine above the SRs.

¹³ †A. Baggs, pers. comm.

¹⁴ The rafters should have a smaller cross section than the ridge beam upon which they rest. Note that for a thatched roof of a small (3.5-5 m) and medium (7 m) horizontal span, the rafters (in a truss system) needed to support a load up to 50kg/m² should be 0.05 m x 0.10 m (*The Thatcher's Craft*, 218; Hall 1988, 10). Also note that in *The Building Regulations 1976*, table 23, for a roof pitch up to 42.50° (no data for a roof pitch over 42.50°), a dead load supported by rafter (excluding the mass of the rafter) of not more than 50 kg/m², a spacing of rafters between 0.40-0.60 m, and a maximum span of rafter equal to 5.13 m (no data for greater spans), the size of rafters should be 0.05 x 0.15 m. It should also be borne in mind that the old timbers were much sturdier than what is now considered necessary: in traditional English timber-framed buildings, the timbers are heavier than in modern construction (Harris 1980, 11); on the use of heavy timber frames in Medieval Europe, see Singer et al. 1956, 233; the ancient Greeks, too, ‘were always given to using very heavy timbers’ (Hodge 1960, 36).

¹⁵ Hall 1988, 10-11, fig. 3.3. Cf. twin battens in a Baruya house, Papua New Guinea (Coudart 1998, fig. 75) or in the reconstruction of the Bronze Age and Celtic houses in Százhalombattai (Hungary) (Jerem et al. 2010, fig. 43).

¹⁶ R. M. Foster, pers. comm.

¹⁷ Based on proportionally comparable braces in Harris 1979, fig. 8: middle; cf. also Harris 1979, pl. 9.

¹⁸ This is the cross-section recommended in *Building Regulations 1973*, Schedule 4, table 1 for a maximum span of joist 5.49 m, spacing of joists at 400 mm c/c, and a dead load supported by joists up to 25 kg/m². The span of joist for the loft above the ER and the Porch is c.5.40 m (Appendix 4: II, Fig. A4:3).

¹⁹ The span of joist in the mezzanine above the SRs is c.3.75 m (Appendix 4: III, Fig. A4:4). The cross-section recommended in *Building Regulations 1973*, Schedule 4, table 1 for a maximum span of joist 3.80 m, spacing of joists at 400 mm c/c, and a dead load supported by joist up to 25 kg/m² is 50 x 175 mm. Converted to the nearest subdivision of the assumed local unit of length, the cross-section of 50 x 175 mm becomes 56 x 168.5 mm (3 fingers x 9 fingers) or 56 x 187.5 mm (3 fingers x 10 fingers), the latter being more likely, since sturdier timbers were preferred in antiquity (*supra*).

²⁰ A ledge is a horizontal beam pegged onto the inside face of the timber frame to support the floor joists of an upper floor (Harris 1979, 26).

Cross-section: 0.112 m x 0.206 m (6 fingers x 11 fingers); placed ‘on edge’.²¹

Posts in corners between antae and front wall of SRs

Cross-section: 0.075 m x 0.112 m (1 palm x 6 fingers),²² which fits the space available in Pit 1 next to the anta of the NR (main article, Fig. 3).

Beams across the front of the SRs

Beams for supporting the floor joists of the mezzanine above the SRs.

Cross-section: 0.112 m x 0.206 m (6 fingers x 11 fingers), like the ledge fixed on to the inside face of the wall posts for the same purpose (*supra*), and of the same thickness as the width of the posts in the corners between antae and front wall of the SRs (*supra*), upon which these beams would have rested; placed ‘on edge’.

Treads on staircase

Thickness: 0.056 m (3 fingers).²³

Floorboards in loft and mezzanine

Thickness: 0.0375 m (2 fingers); width: 0.28 m (15 fingers).²⁴

IV. TIMBER JOINTS

Mortise-and-tenon joints

Mortise-and-tenon joints would have been used to firmly secure (a) the ridge beams onto the centre posts and the plates on top of the wall- and veranda posts, leaving the upper surface of the ridge and the plates intact and even for the ‘sitting’ of the rafters (Figs A3:1, A3:2, A3:3; main article, Figs 7, 12); (b) the plates on top of the studs in the partition across the ER (Fig. A3:4c; main article, Fig. 12); (c) the plates on top of the ‘triptych’ posts in the AR (main article, Fig. 12); (d) the king posts over the crossbeams in the areas of the partition walls (main article, Figs 8, 9, 12); (e) the diagonal braces to the crossbeams and the nearest wall posts; and (f) the probably extended jambs of the doorways of the AR and CR to the crossbeams. The joints in (a), (b) and (c) would have been kept tight with a peg and wedges, while for the fixing of the king posts on top of the crossbeams, a short stub-tenon without a peg would have been used (cf. Brunskill 1994, 37).

The thickness of the tenons at the top of the wall- and veranda posts, and correspondingly the width of the mortise cut into the plates over these posts, can be reconstructed as equal to 0.0187 m (1 finger), while the pegs through such a mortise-and-tenon joint can be reconstructed as 0.0093 m in diameter. The thickness of the tenons at the top of the centre posts, and correspondingly the width of the mortise cut into the ridge beams over these posts, can be reconstructed as equal to 0.0375 m (2 fingers) and their pegs 0.0187 m (1 finger) in

²¹ Cf. girding beams or girders (having the same function as ledges): see Harris 1979, 26, fig. 19 – no scale: rectangular girding beams, with depth equal to twice their thickness, and similarly sized ledges); Sobon and Schroeder 1984, 123-4: square girders, 4 x 4 inches/0.10 x 0.10 m). The thickness of 0.112 m (6 fingers) is the closest subdivision to 0.10 m of the assumed unit of length at LK-T.

²² The dimension 0.112 m (6 fingers) is the closest subdivision to 0.10 m of the assumed local unit of length.

²³ Cf. Boards (*sanides*) 3 fingers thick mentioned in ancient Greek texts (Hodge 1960, 123).

²⁴ Planks 0.025m thick were used for the lateral posts in houses at Neolithic Anza IV in central Balkans (Treuil 1983, 249 n. 6 with refs.). Nowadays, the nominal thickness of floorboards is 0.025 m (Sealey 1980, 81). The dimension 0.28 m is the maximum width of the wall- and veranda posts (Popham et al. 1993, table 2: posts S8 and S26). ‘Split planks’ 0.30 m wide, perhaps part of a roof, have been uncovered at Neolithic Prodromos 2 in Greece (Hourmouziades 1971 cited in Perlès 2001, 191). Wide-plank boards minimised the work required to cover the floor surface, the goal being to use the smallest number of boards to cover a surface. Old houses in Europe tended to have wide-plank floors, one to two feet wide; the wide-plank boards were extracted from huge trees, and they would have been cut using a saw pit; the trunks were sliced into quarters and then the planks were cut at a 45° angle from those quarters, creating ‘quarter-sawn wood’ (Seeley 1980, fig. 6.4.6), which resists cupping (bowing upwards, a form of warping); therefore, this cutting technique created the most stable plank (†A. Baggs, pers. comm.). Regarding lengths, boards (*sanides*) of 10, 15 and 16 feet are mentioned in ancient Greek texts (Kakaras 2013, 112).

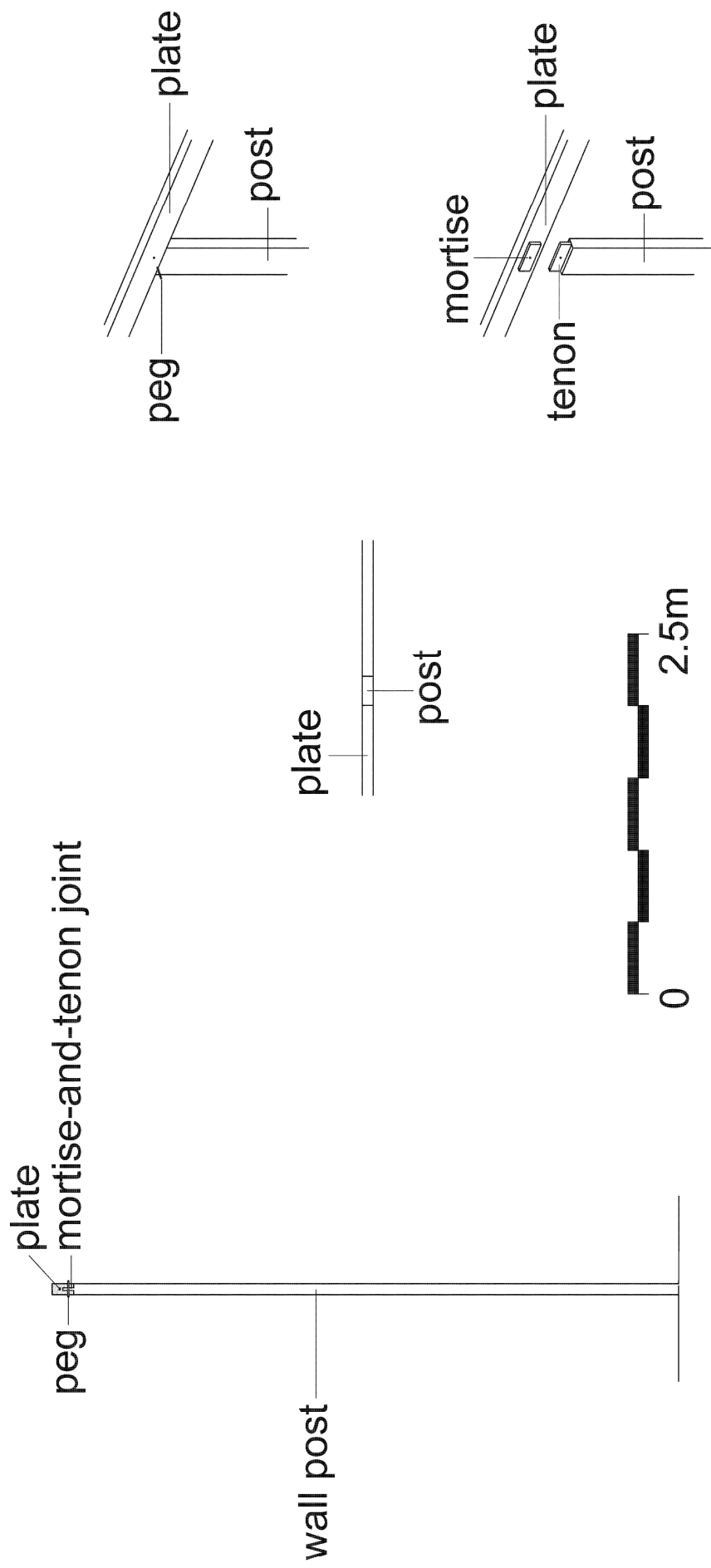


Fig. A3:1. Reconstruction of the sitting of the plate above a wall post using mortise-and-tenon joint.

diameter; the same dimensions apply to the tenons at the top of the posts of the ‘triptych’-like structure in the AR, their corresponding mortises, and their pegs.²⁵

The mortise-and-tenon joint is a bearing joint, used when one timber member is carried by another (Brunskill 1994, 36-7); it is the most important type of joint in timber-framing and one that resists torsion and provides special stability, due to its interlocking effect (Orlandos 1966, 47-8; Acland 1972, 12; Forrester 1975, 23-4; Harris 1979, 12-13; Sobon and Schroeder 1984, 42-4; Brown 1986, 33; Brunskill 1994, 37, 143; Zwerger 2015, 88-9, 121, 123), which is further enhanced when the timbers have been assembled without drying (Bayford 2001, 14).

Birdsmouth joints

This type of joints would have been used for the sitting of the rafters on the ridge beam and the plates (in a way such that the birdsmouth cutout in the bottom of the rafter did not cut into the rafter more than 1/3 of the rafter’s depth so as to maintain its structural integrity) (Fig. A3:2; main article, Figs 7, 8, 9, 11, 12). This is a type of oblique joint that resists outward thrust and does not require cutting wood out of the plate (see *The Thatcher’s Craft*, 212; Smith 1983, Series 1, Sheet No. 53, fig. 2; Sobon and Schroeder 1984, 46-7; Brunskill 1994, 99; Zwerger 2015, 89).

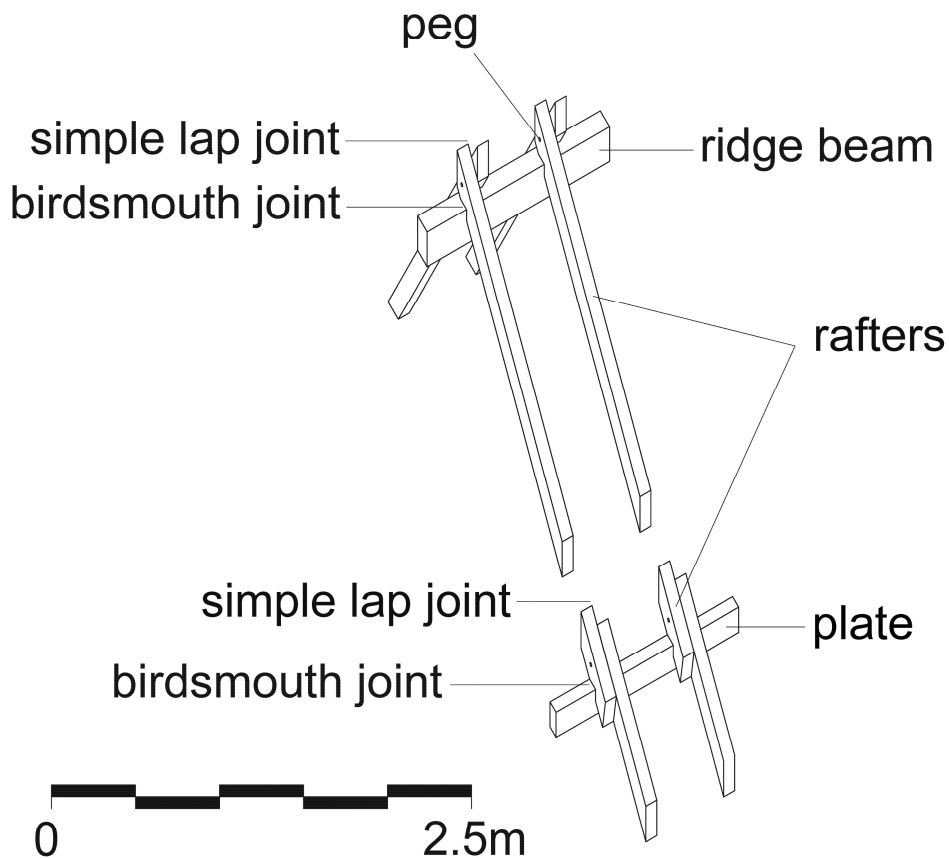


Fig. A3:2. Reconstruction of adjacent rafters joined together using a simple lap joint and a peg and sitting onto the ridge beam (at the top) and on the plate above the wall posts (at the bottom) using birdsmouth joints.

²⁵ This is because, according to traditional practice, a tenon should be 1/3 or 1/4 of the timber’s thickness, while a peg should be half the tenon’s thickness. The dimension 0.0187 m (1 finger) of the mortise-and-tenon joint for the plates on top of the wall- and veranda posts represents 1/3 of 0.056 m (3 fingers) – the minimum thickness of the wall- and veranda posts is 0.05 m (Popham et al. 1993, table 2) converted to the nearest subdivision of the assumed local unit of length – and 1/4 of a 0.075m-thick plate (*supra*).

Lap joints

Lap joints (where one member passes over another) of various types would have been used. Thus:

- (a) a simple lap joint: for the joining of two adjacent rafters and of two adjacent loft joists together, where neither member was cut so as not to be weakened and were only attached to one another by means of a peg²⁶ (Fig. A3:2 showing the adjacent rafters);
- (b) a type of half-lapped (or halved-and-lapped) joint for the joining together of two plates meeting together on top of the wall- and veranda posts and of two ridge beams meeting together on top of the centre posts; more particularly, in these cases, an edge-halved and grooved scarf joint with mortises fitting onto the tenons of the wall- and veranda posts would have been used, as shown in Fig. A3:3, and similarly for the centre posts (see Sobon and Schroeder 1984, 93-5; Brunskill 1994, 39, 142-5; Zwerger 2015, 88), resulting in compound joints (Brunskill 1994, 40). Scarf joints are lengthening joints, used in order to maintain a uniform cross-section for long wooden members consisting of sections whose length is limited by the available timber and to help them resist sagging or bending; they are used together with pegs and wedges for tightening (Brunskill 1994, 36, 38-9); and
- (c) notched joints: for the sitting of the crossbeams onto the wall-posts' plates at either end (Fig. A3:4a; main article, Fig. 8); for the sitting of the joists of the loft on the crossbeams and on the plates above the studs of the partition in the ER (Fig. A3:4b; main article, Figs 8, 12) as well as of the joists of the mezzanine above the SRs both on a beam across the front of the SRs resting on the posts next to the antae, at the front, and on a ledge attached to the wall posts, at the back, and for the securing of the beam across the front of the SRs onto the posts next to the antae (Fig. A3:4c) (in a way such that the notch created did not exceed more than 1/3 of the timber's depth) (see Sobon and Schroeder 1984, 47; Brunskill 1994, 142-3; Zwerger 2015, 88).

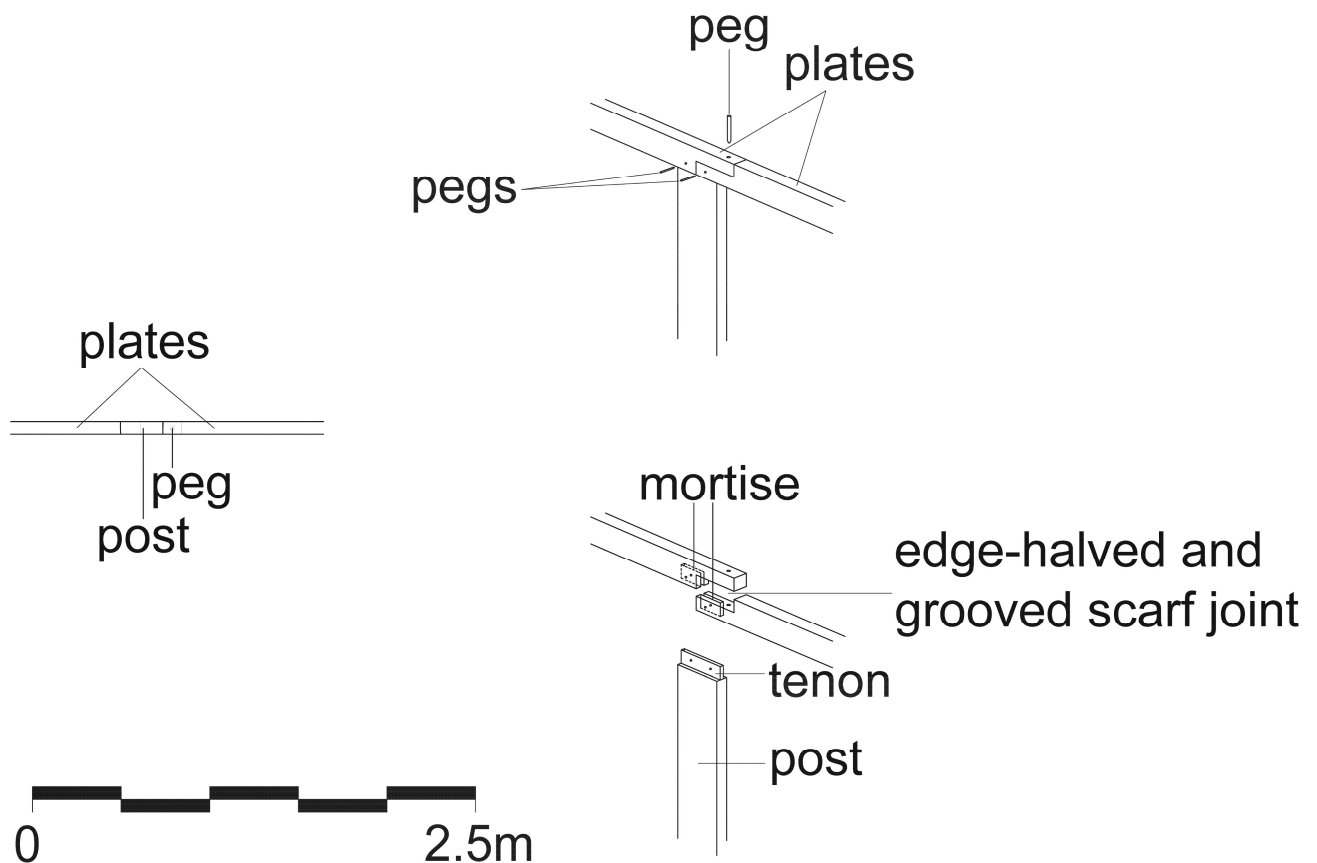


Fig. A3:3. Reconstruction of the joining together of two plates meeting on top of a wall- or veranda post using a compound joint made of an edge-halved and grooved scarf joint with mortises fitting onto the tenon of the post.

²⁶ The more complex version, that of a half-lapped (or halved-and-lapped) joint, is more secure but has the disadvantage of weakening both members – see Brunskill 1994, 37-38, 142, figs. d131 (simple lap joint) and d133 (half-lapped joint).

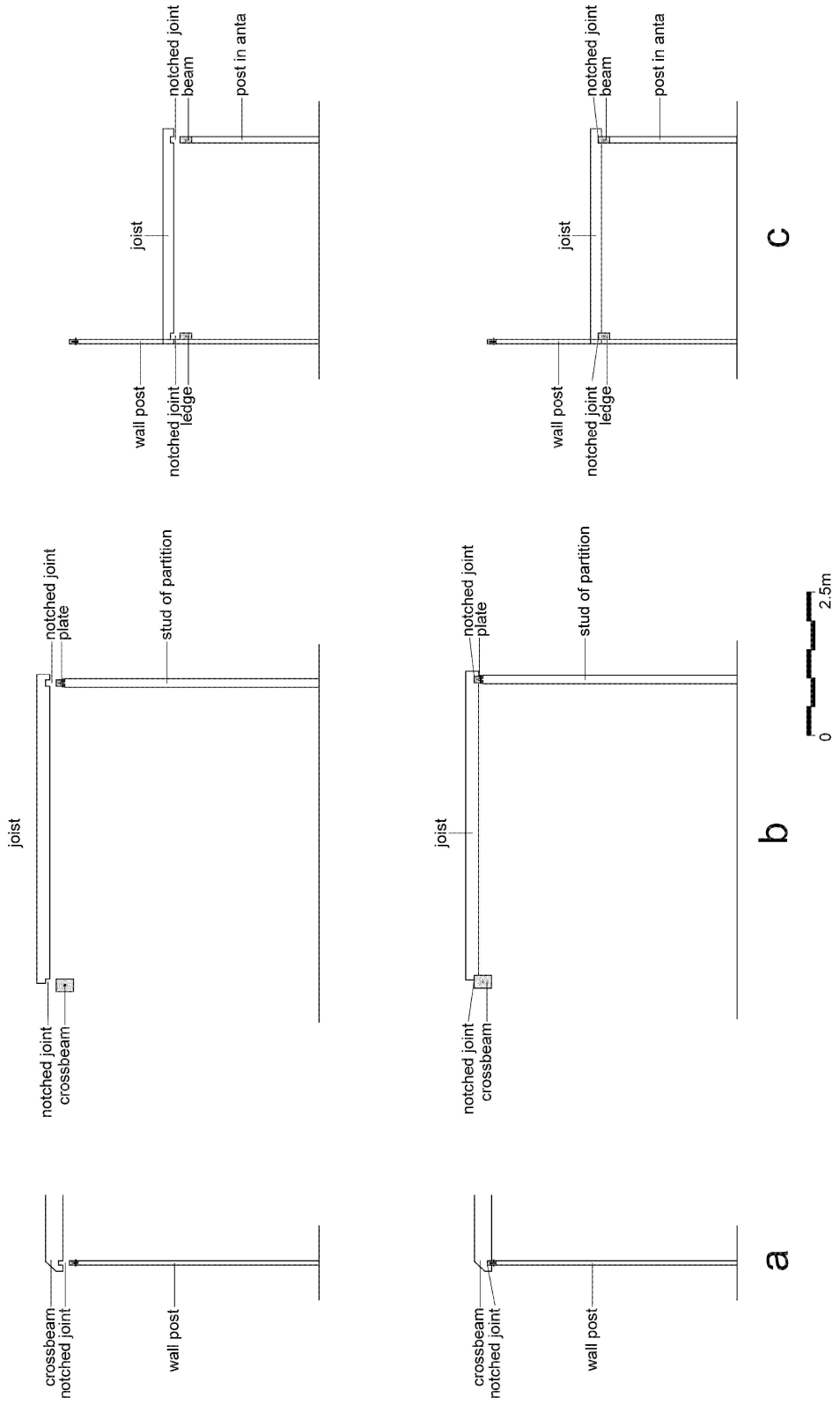


Fig. A.3:4. Reconstruction of (a) the sitting of a crossbeam on the plate of the wall posts using a notched joint; (b) the sitting of a loft joist on the crossbeam and on the plate above the studs of the partition in the ER by means of notched joints; (c) the sitting of a mezzanine joist on a beam across the front of the SRs (right) and a ledge (left) using notched joints.

REFERENCES

- Acland, J.H. 1972. *Medieval Structure: The Gothic Vault* (Toronto).
- Bayford, A. 2001. 'The Management and Conversion of Timber for Building', *Eavesdropper* 18, 11-14.
- Brown, R.J. 1986. *Timber-Framed Buildings in England* (London).
- Brunskill, R.W. 1994. *Timber Building in Britain*, 2nd edn (London).
- Coudart, A. 1998. *Architecture et société néolithique. L'unité et la variance de la maison danubienne* (Paris).
- Forrester, H. 1975. *The Timber-framed Houses of Essex* (London).
- Hall, N. 1988. *Thatching: A Handbook* (London).
- Harris, R. 1979. *Discovering Timber-framed Buildings*, 2nd edn (Princes Risborough).
- Hodge, A.T. 1960. *The Woodwork of Greek Roofs* (Cambridge).
- Hourmouziadis G. 1971. 'Δύο νέα εγκαταστάσεις της αρχαιότερας νεολιθικής εις την δυτικήν Θεσσαλίαν', *Athens Annals of Archaeology* 4.2, 164-75.
- Jerem E., Vasáros Z. and Vicze M. (eds) 2010. *Turisztikai vezető a Százhalombattai Régészeti Park láttnivalóihoz* (Budapest).
- Orlandos, A. 1966. *Les matériaux de construction et la technique architecturale des anciens Grecs*. Part I (Paris).
- Perlès, C. 2001. *The Early Neolithic in Greece: The First Farming Communities in Europe* (Cambridge).
- Popham, M.R., Calligas, P.G., and Sackett, L.H. (eds) 1993. *Lefkandi II. The Protogeometric Building at Toumba. Part 2: The Excavation, Architecture and Finds* (London).
- Seeley, I.H. 1980. *Building Technology* (Houndmills and London).
- Smith, S. 1983. *Builders' Detail Sheets*. Series 1 (London).
- Sobon, J. and Schroeder, R. 1984. *Timber frame construction: all about post and beam building* (Pownal, Vt.).
- The Thatcher's Craft* 1961. The Rural Industries Bureau, Publication 69 (London).
- Zwenger, K. 2015. *Wood and Wood Joints. Building Traditions of Europe, Japan and China* (Basel).

Table A3:1. Dimensions and depths of posts (or post pits) in the LK-T building
(Based on Popham *et al.* 1993, table 2. All dimensions are in cm.)

No.	Pit depth*	Post size
		Wall- and veranda posts E-W x N-S x depth ²⁷
VN1		26 x 9 x ?
VN2		23 x 9 x ?
VN3		15 x 7 x ?
VN4		22 x 9 x ?
VN5		18 x 7 x ?
VN6		24 x 6 x ?
VN7		24 x 7 x ?
VN9		19 x 7 x 62
VN10		20 x 7 x ?
VN11		22 x 8 x ?
VN12		24 x 8 x ?
VN13	61	22 x 8 x 60
VN14	60	
VN25		
VN27	68	
VN28		
VN29		
VN30		
N1		26 x 10 x ?
N2		25 x 8 x ?
N3		23 x 5 x ?
N4		22 x 6 x ?
N5		20 x 5 x ?
N6		24 x 6 x ?
N7		23 x 5 x ?
N8		19 x 5 x ?
N9		23 x 5 x ?
N10		22 x 6 x ?
N11		24 x 8 x ?
N12		26 x 7 x ?
N13		
N14		? x 7 x ?
N25	50	
N26	50	
N27		
S1		18 x 8 x ?
S2		25 x 10 x ?
S3		24 x 9 x ?
S4		20 x 8 x ?
S5		23 x 10 x ?
S6		20 x 8 x ?
S7		26 x 10 x ?
S8		28 x 8 x ?
S9		17 x 5 x 53
S10		26 x 8 x 76
S11		21 x 8 x ?
S12	70	23 x 7 x ?
S13		23 x 6 x ?
S24	70	
S24a	50	
S25		23 x 7 x ?
S26		28 x 6 x ?
S27		20 x 6 x ?
VS1		22 x 7 x ?
VS2		20 x 8 x ?
VS3		19 x 8 x ?
VS4		22 x 8 x ?
VS5		17 x 5 x ?
VS6		20 x 7 x ?
VS7		20 x 6 x ?
VS8		19 x 8.5 x ?
VS9		20 x 7 x ?

²⁷ Only ascertained depths have been taken into consideration.

VS10		20 x 6 x ?
VS11		27 x 6 x ?
VS12	68	
VS13		
VS14		
VS16		
VS24	40	
VS25	40	
VS26	50	
VS27		
VS28		20 x 6 x ?

Average width of posts = 22; average thickness of posts = 7.2; average depth of posts or their pits = 57.9.

Centre Posts		D. = Diameter; dp. = depth
C1		D. 20
C2		D. 20-25 (av. 22.5 ²⁸)
C3		D. 22
C4	140	D. 18-c.30 ²⁹ (av. 24); dp. 140
C5	148	D. 22; dp. 148
C10 ³⁰		D. 23

Average D = 22.25; average dp. = 144.

²⁸ C2 measures 22.5 cm in Popham et al. 1993, pl. 38. Note that 0.225 m = 3 palms (see Section I).

²⁹ For C4, Popham et al. 1993, table 2 records a D = 18 cm (cf. Popham et al. 1993, 16); in fact, this represents the lower diameter of the cast made of the imprint of C4, while the upper diameter of the cast appears to be c.30 cm (see Popham et al. 1993, pl. 30*d*; cf. Popham et al. 1993, pls 9, 38, where the upper diameter measures 0.28 m in plan) (see also Appendix 2: Introduction).

³⁰ C10 is considered here as the last centre post, C11 being part of the 'triptych'-like structure supporting the hipped roof over the west half of the apse (main article, Figs 6, 10, 11, 12).

APPENDIX 4 THE STAIRCASE, THE LOFT, AND THE MEZZANINE

by Alexandra Coucouzeli

I. THE STAIRCASE

In the north-east corner of the CR there are two parallel walls, which can safely be identified as the remains of the stone base of a staircase, distant 0.45 m (1 foot 2 palms) from each other as well as from the (northern half of the) partition wall between CR-ER, bringing to 1.80 m (= 4 x 0.45 m) the total width of the space seemingly assigned to the staircase (main article, Fig. 3; Fig. A4:1). This would have been a dog-leg (or half turn) staircase,¹ with two flights of steps, made of wooden treads resting on the stepped superstructure of the two parallel walls, presumably in mudbrick, and, on the eastern side, inserted into the mudbrick superstructure of the (northern half of the) partition wall between CR-ER. The staircase would have been intended primarily to provide access to a loft above the ER and Porch (see *infra*, Section II) and secondarily perhaps also to a mezzanine above the northern series of reconstructed cabins in the CR (see *infra*, Section III). More particularly, the staircase can be reconstructed as follows.²

Since the south end of the central wall of the staircase presents a height of *c.* 0.40m, which is too high for a first step, it should be assumed to represent approximately the height of the second step. Considering a thickness of 0.056 m (3 fingers) for the wooden tread (Appendix 3: III), this would bring the height of the second step to *c.* 0.45 m (1 foot 2 palms). The first step can then be reconstructed at half that height, i.e. 0.225 m (3 palms) high, standing independently and added in front of the second step. This first step would have been placed at an angle, as suggested by Pits 16 and 17 at the south end of the central wall,³ and it would therefore have been a winder, creating a nice curve that would have facilitated access and the flow of circulation from the CR to the staircase. Due to the angled positioning of the first step, the second step would have been triangular in shape and similarly placed at an angle. The angled positioning of the first two steps of the staircase would therefore explain why the western wall of the latter is recessed with respect to the central wall. The fact that Pits 16 and 17 are located in the area of the second step suggests that the latter would have been supported by two short posts or ‘risers’⁴ (reconstructed dimensions: 0.0375 m or 2 fingers square) inserted into the aforementioned pits (Fig. A4:1a). These posts would have been set against the first, additional step, which could well have been the large stone found in the fill of this area and measuring 0.70 x 0.30 x 0.30 m (Popham et al. 1993, 30) (*c.* 2 feet 5 fingers x 1 foot x 1 foot): placed right against the (reconstructed) posts, this stone would have protruded from the second step by 0.225 m (3 palms) and it could have been sunk into the ground by 0.075 m, bringing its height above the ground to 0.225 m. Finally, a horizontal tread support would have been used as an infill in the space between the first two steps and between the posts.⁵

We can now proceed to the reconstruction of the remaining staircase. If the first two steps or risers were 0.225 m high each (*supra*), then the remaining steps or risers can be reconstructed as having the same height. The distance 0.90 m (3 feet) from the midline of the western wall to the midline of the central wall of the staircase would represent the width of each flight of steps. The distance 2.925 m (9 feet 3 palms) between the south end of the central wall of the staircase and the (inner face of the) north wall in the CR can be subdivided into 9 steps, i.e. treads or goings, each 0.225 m deep, plus a landing 0.90 m (3 feet) wide, equal to the width of each flight of steps – which is reasonable since landings are usually as wide as the flight of steps⁶ (Fig. A4:1a). As we have seen, however, the first of these 9 steps or goings, i.e. in actual fact,

¹ Seeley 1980, 144; Smith 1983, Series 2, sheet no. 24. Cf. the dog-leg, Π-shaped staircases at Akrotiri, Thera (Palyvou 2005, fig. 190).

² Our proposed reconstruction eliminates all the difficulties raised by the excavators for such a staircase (Popham et al. 1993, 51).

³ For Pits 16 and 17, see Popham et al. 1993, pl. 9; depths of pits: 23+ cm and 18+ cm, respectively (Popham et al. 1993, table 4).

⁴ Cf. the solid bar risers forming part of the Nuway stairs for the support of the wooden treads (Smith 1983, Series 2, sheet no. 32, figs 9, 10).

⁵ I owe the reconstruction of the first two steps to Jorge Moreira ARB.

⁶ Jorge Moreira, pers. comm.

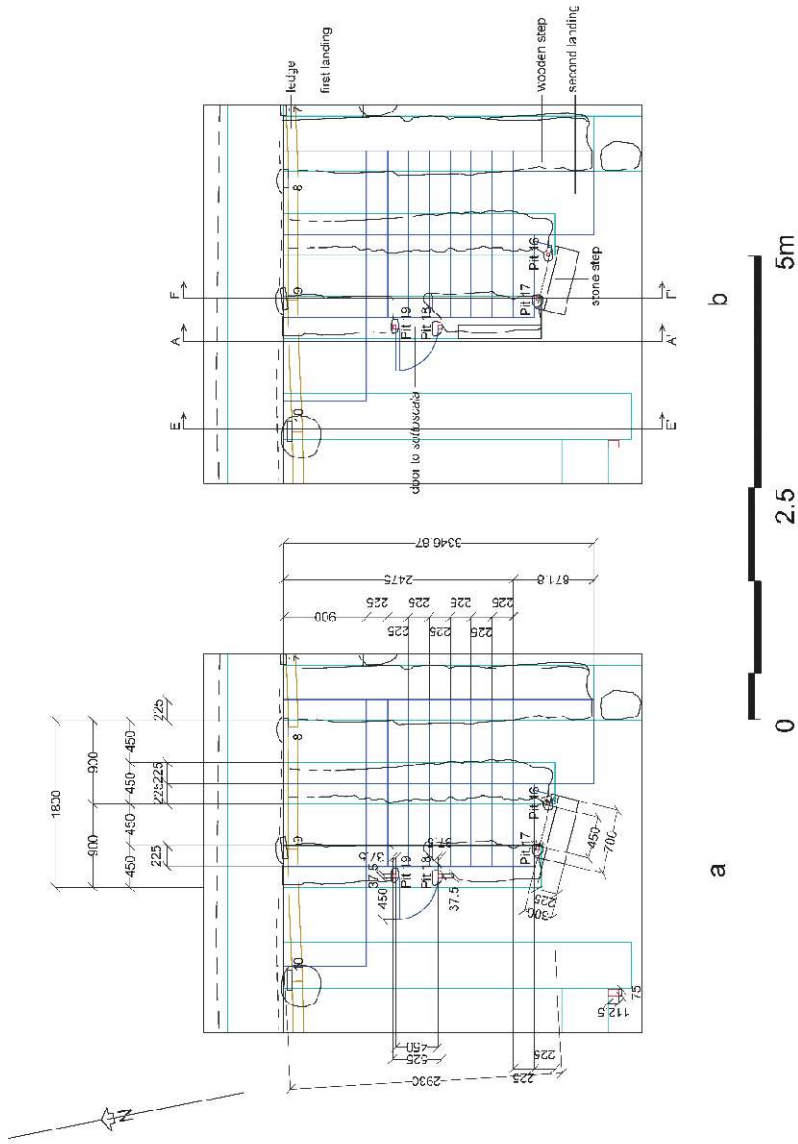


Fig. A4:1. Reconstruction of the plan of the staircase in the north-east corner of the CR (in blue), superimposed on the reconstructed idealised plan of this part of the building (in green) and the existing plan (in black): (a) with dimensions; (b) with annotations.

the second step (since the first step was an independent object) was triangular rather than rectangular, due to the obliquity of the separate first step.

With all the steps being equal in height and depth, 0.225 m high x 0.225 m deep, the first flight would have comprised, beyond the independent first step, 9 steps ending at a first landing measuring 0.90 m x 0.90 m, at a height of 2.475 m (8 feet 1 palm) from the floor; the pitch of the first flight would have been equal to 45° (Fig. A4:2a). The first landing, extended towards the west (Fig. A4:1), could give access to a mezzanine above the north row of reconstructed cabins in the CR (*infra*, Section III).⁷

As regards the second flight, this can be reconstructed with seven steps leading to a second landing, 0.875 m wide, at a height of 4.275 m from the floor (Fig. A4:2a). Interestingly, this is also the reconstructed height (from the floor) of the underside of the crossbeam supporting the floor joists of the loft (based on a roof pitch of 45° and on the way the crossbeam would have been notched onto the wall post plates down to 1/3 of its depth) (see main article, Fig. 8; Appendix 3: IV). The distance of the loft from the second landing would be 0.45 m (i.e. the added depths of the crossbeam and of the loft joists notched onto it down to 1/3 of their depth), which is also the equivalent of two steps, plus the thickness of the floorboards (see Appendix 3: III). This distance would have been bridged using an additional wooden step, 0.225 m in height, placed on the second landing, along the crossbeam (and, interestingly, with its upper surface aligned with the underside of the joists). The additional step would bring the total height of the staircase to 4.50 m (Fig. A4:2a; main article, Fig. 8), equal to half the internal width of the building and half its reconstructed internal height (up to the top of the rafters' crossing) (main article, Fig. 7).

As regards the second flight, this can be reconstructed with seven steps leading to a second landing, 0.875 m wide, at a height of 4.275 m from the floor (Fig. A4:2a). Interestingly, this is also the reconstructed height (from the floor) of the underside of the crossbeam supporting the floor joists of the loft (based on a roof pitch of 45° and on the way the crossbeam would have been notched onto the wall post plates down to 1/3 of its depth) (see main article, Fig. 8; Appendix 3: IV). The distance of the loft from the second landing would be 0.45 m (i.e. the added depths of the crossbeam and of the loft joists notched onto it down to 1/3 of their depth), which is also the equivalent of two steps, plus the thickness of the floorboards (see Appendix 3: III). This distance would have been bridged using an additional wooden step, 0.225 m in height, placed on the second landing, along the crossbeam (and, interestingly, with its upper surface aligned with the underside of the joists). The additional step would bring the total height of the staircase to 4.50 m (Fig. A4:2a; main article, Fig. 8), equal to half the internal width of the building and half its reconstructed internal height (up to the top of the rafters' crossing) (main article, Fig. 7).

Thus, the central wall of the staircase would have been divided into two halves, both with a stepped superstructure, presumably of mudbricks, one half supporting the timber treads of the first flight of steps and reaching a maximum height of 2.47 m at its north end (first landing), the other half supporting (together with the mudbrick superstructure of the north half of the partition wall between CR-ER) the timber treads of the second flight of steps, starting from the first landing and ending at a height of 4.50 m above the floor; the west wall of the staircase would have also had a stepped superstructure, presumably of mudbricks, reaching the height of the first landing (Figs A4:2bc; main article, Fig. 8).

A door has been rightly assumed by the excavators to have existed 'halfway along the most westerly wall' and to have been 'framed by light timbers set in pits nos. 18-19' (Popham et al. 1993, 14, 50-1, pl. 9). The door can be reconstructed as 0.45 m wide, with 0.0375 m or 2 fingers square jambs (Fig. A4:1a). It would have given access to a *sottoscala*, perhaps intended as a storage space and extending under the first flight of stairs as well as (via the gap between of the central wall of the staircase and the north wall of the CR) under the second flight, where the space would be more comfortable in terms of height (Fig. A4:1b).⁸ It must then be assumed that there was no direct access from the CR to the *sottoscala* extending under the second flight and that this space was intended to be blocked, probably with planks. The presence of a door under the first flight and the need for it to open outwards would thus explain why the northern row of the reconstructed cabins

⁷ Cf. Minoan staircases, 'where the middle landing gives access to an intermediate level, especially at Akrotiri' (Palyvou 2018, 70).

⁸ Cf. the *sottoscala* under Minoan staircases: see, for instance, Shaw 2015, 35, fig. 1.41: Malia palace, staircase north of Room IX; see also Palyvou 2005, 135 ('the second flight will have enough space underneath it for storage'); 2018, 70 ('II-shaped staircases, with the area underneath the second flight used as storage space').

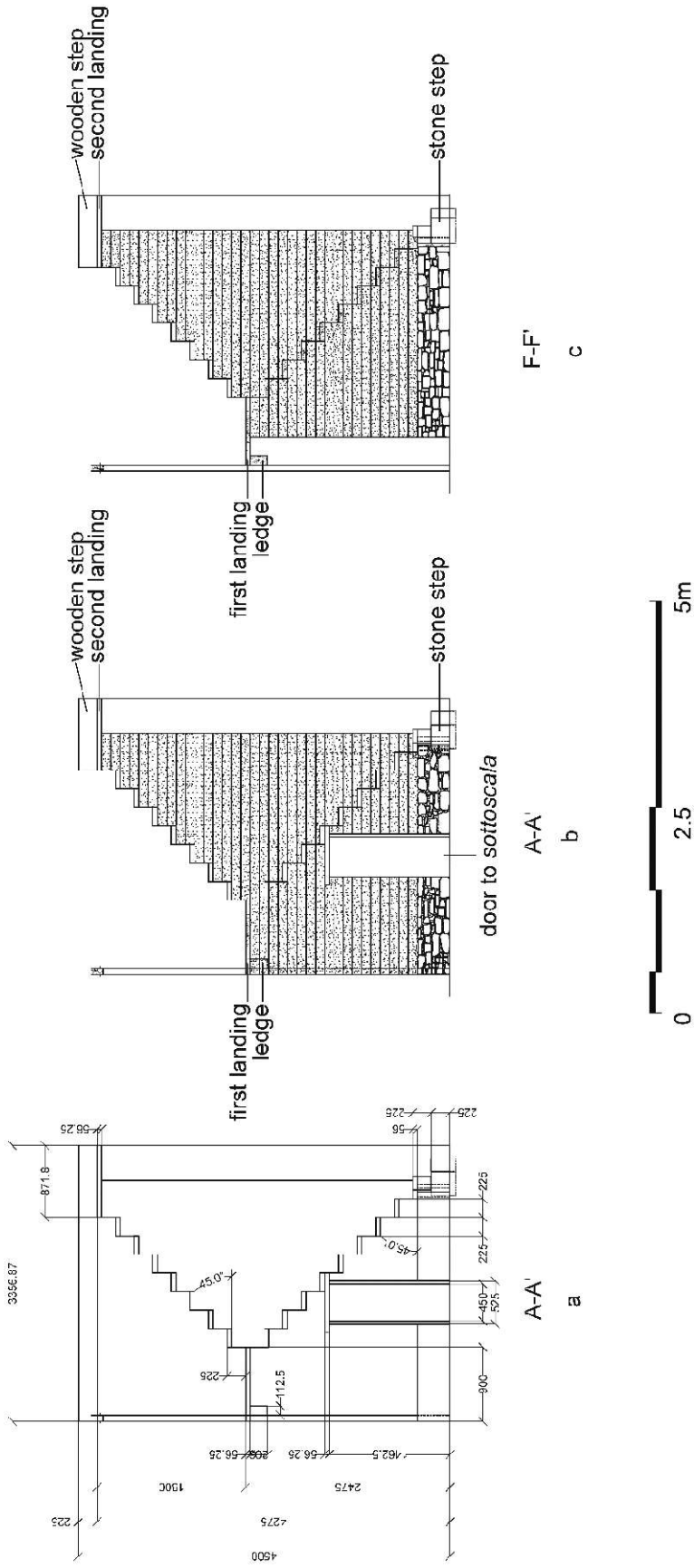


Fig. A4-2. Reconstruction of the elevation and cross-section of the staircase: (a) elevation along section A-A' (see Fig. A4-1b) with dimensions; (b) elevation along section A-A' with detailing of the building materials and annotations; (c) cross-section along section F-F' (see Fig. A4-1b) with detailing of the building materials and annotations.

in the CR does not go up to the staircase but stops at a certain distance from it (0.60 m), leaving enough space to access the *sottoscala* (main article: Introduction and Fig. 3).

Since no wood residue was found in Pits 16-17 and Pits 18-19 (Popham et al. 1993, 14-5), it seems unlikely that the construction of the staircase had advanced beyond the stage of the stone socles.

II. THE LOFT

The loft above the ER and the Porch may have been used for drying and storing grain and other produce, being duly elevated from the ground to avoid humidity and mouse infestation, perhaps also for spinning and loom weaving, and even for sleeping.⁹ The evidence for a loft is based on (a) the existence of the base of a staircase in the northeast corner of the CR, which, according to its most likely reconstruction suggested above (Section I), was intended as a dog-leg staircase with two flights of steps consisting of 16 treads, clear proof that it would have led to an upper floor;¹⁰ and (b) the presence, across the middle of the ER, of a series of pits¹¹ (main article, Fig. 1) for the studs of a partition, which had an obvious structural function, since its central stud, on the long axis of the building, is situated in the middle of the distance of 10.80 m between a line tangent to the centre post C1 and a line distant 0.22 m to the west of the midline of the partition wall between CR-ER (Fig. A4:3; main article, Fig. 10); this cannot be a coincidence and implies that the crossbeam in the area of the partition wall between CR-ER with its superincumbent king post (K1) would have notionally been 'moved' to the western edge of the aforementioned wall to support the joists of a loft above the ER and Porch in conjunction with another crossbeam adjacent to the centre post C1 as well as the studs of the partition across the ER.¹² (Since the floor joists of the loft could only have been notched (Appendix 3: IV) onto two crossbeams, one at each end of the loft, it can be assumed that no crossbeam existed in the area of the partition wall between Porch-ER.)

The loft can then be reconstructed as follows (Fig. A4:3). Since 'joists should run the shortest span wherever practicable to economise in timber' (Seeley 1980, 83, fig. 6.3.6), one can reconstruct two sets of floor joists running in an E-W direction on either side of the studs of the partition across the middle of the ER and resting in the middle on a plate borne on top of these studs and at their east and west ends on the two crossbeams mentioned above, i.e. respectively a crossbeam passing flush with C1 in the Porch and a crossbeam in the area of the partition wall between CR-ER. The floorboards would have run across the joists in a N-S direction.¹³ The dimensions of the joists and floorboards can be reconstructed as described in Appendix 3: III. Based on the reconstructed depths of the crossbeam and joists (which would have been notched over it) and thickness of the floorboards, as well as the reconstructed height of the crossbeam from the floor (Appendix 3: III; main article, Fig. 8), the loft can be restored to a height of 4.762 m (15 feet 14 fingers) from the floor of the building (main article, Fig. 8).

⁹ Cf. the loft in the form of a high platform supported by wooden posts in the front part of the Bandkeramik Neolithic longhouses, which was used for the storage of grains (Appendix 1: B.2.1) or the attic of the Quiché Maya houses, used the storage of maize (Earle 1986, 166). Cf. also the loft of traditional houses in Thessaly, which was supported on wooden posts and was used for processing (spinning and loom weaving) goat wool and drying maize, onions and other products, even for sleeping in the summer months (Megas 1946, 33, 37).

¹⁰ Cf. Palyvou 2005, 135: 'The [Minoan] builders obviously learned from experience that approximately 16 steps suffice to cover the height of a typical story'.

¹¹ These are Pits 1-8 (Popham et al. 1993, pl. 7).

¹² The excavators did not connect the loft above the ER and the Porch with the partition across the ER; they also assumed that the loft would be accessible by a ladder (Popham et al. 1993, 44, 47, 51-2, pl. 28).

¹³ The excavators' reconstruction of the loft (Popham et al. 1993, pl. 28) differs from our reconstruction, as it shows (a) the floor joists resting upon the walls (which are incorrectly assumed to have been load-bearing) and upon crossbeams jointed to the centre posts (as is the case with the series of crossbeams reconstructed by the excavators throughout the building, but which are not necessary) (see main article), as well as running in a north-south direction (without taking into account their close relationship with the studs of the partition across the ER); and (b) the floorboards lying on the joists in an east-west direction, since the joists themselves are reconstructed in the opposite, north-south direction.

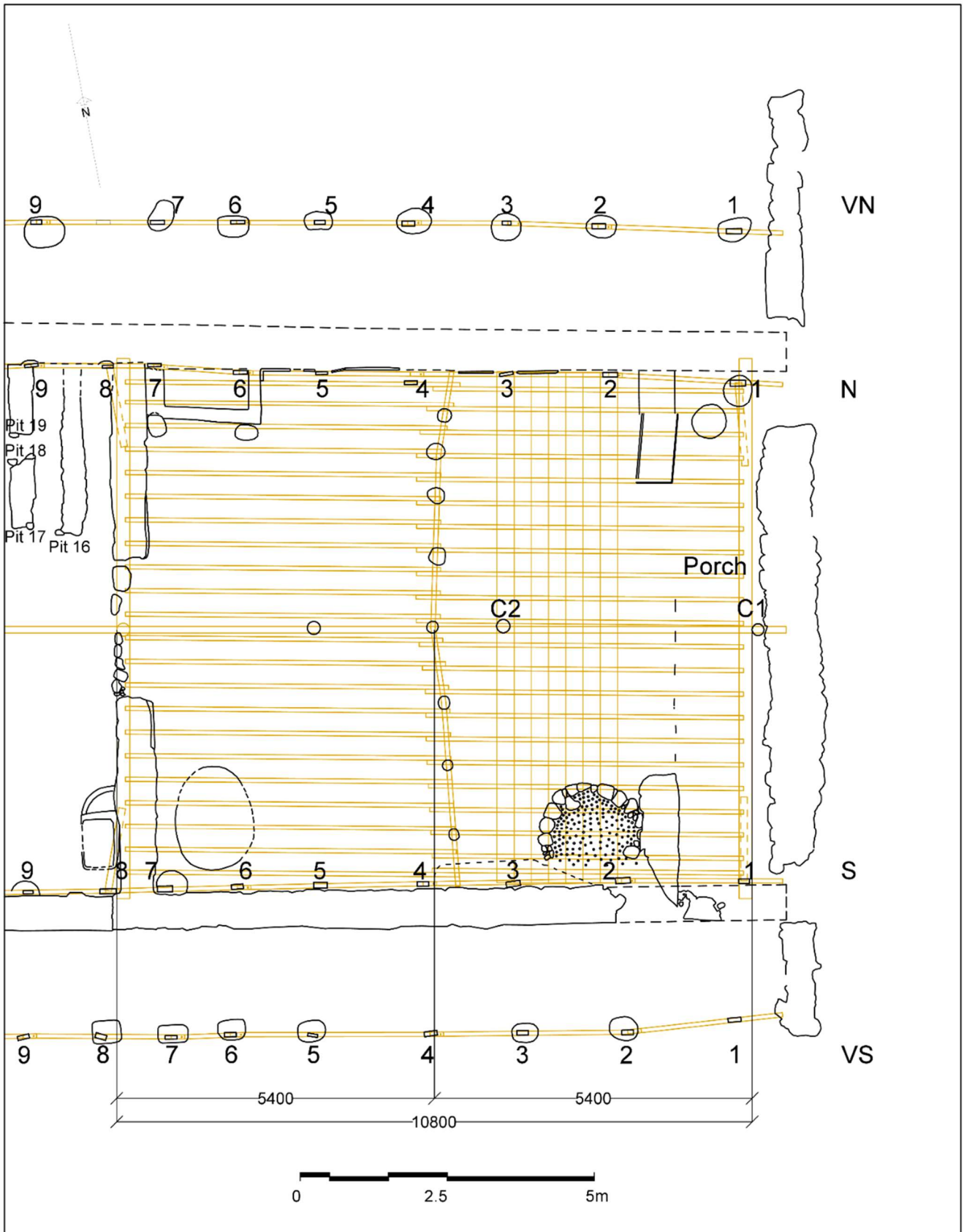


Fig. A4:3. Reconstruction of the plan of the loft above the ER and the Porch (in brown), superimposed on the existing plan of this part of the building (in black).

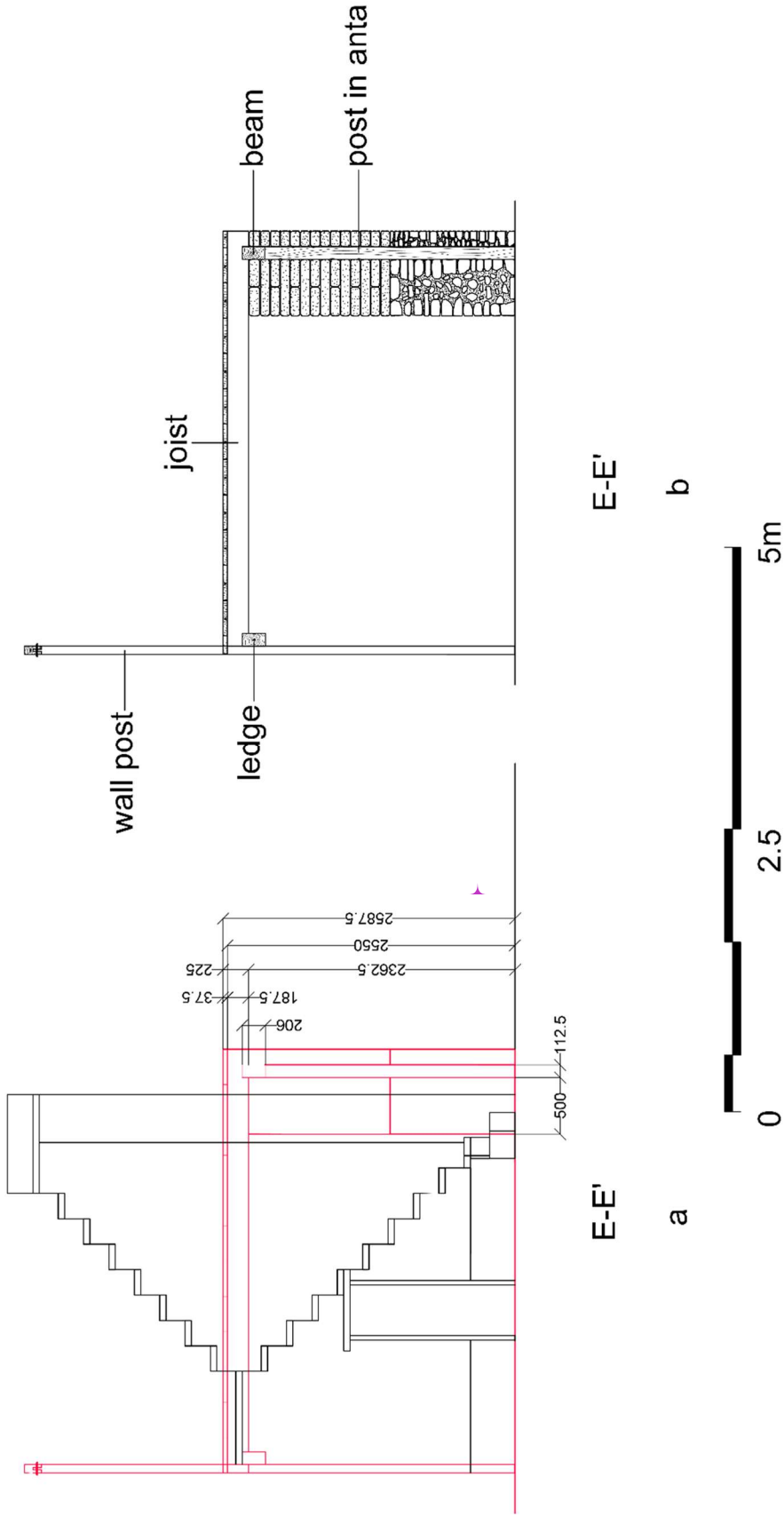


Fig. A4:4. (a) Reconstruction of the cross-section of a hypothetical cabin (in red) against the background of the reconstructed staircase along section E-E' (in black), with dimensions; (b) Reconstruction of the cross-section of a hypothetical cabin with detailing of the building materials and annotations.

III. THE MEZZANINE

We have referred in the main article (Introduction) to a mezzanine that could have been envisaged to extend above the reconstructed cabins in the CR. The mezzanine above the northern row of cabins could have been accessed via the first landing of the staircase (*supra*), while its counterpart on the opposite side could have been accessed by means of boards laid horizontally to bridge the gap between them or simply by a ladder.

Evidence that the SRs were designed to be covered by a roof thereby creating a mezzanine is provided by the presence of Pit 1 in the corner between the front wall and the east anta of the NR (main article, Fig. 1): a post embedded into it could support, in conjunction with another post next to the west anta, a beam running across the front of the room, which would in turn carry a series of roof joists; the latter would run in a N-S direction, resting at the rear on a ledge fixed to the wall posts (and on which could also have partially rested the first landing of the staircase that could have given access to the mezzanine) (Figs A4:1, A4:4; main article, Figs 3, 9; Appendix 3: III). The floorboards of the mezzanine would have rested on the joists, running across them in an E-W direction. The dimensions of the joists and floorboards, the ledge, and the beam and posts at the front of the SRs, as well as the types of joints connecting these wooden elements together, can be reconstructed as described in Appendix 3: III, IV.

REFERENCES

- Earle, D.M. 1986. 'The Metaphor of the Day in Quiche: Notes on the Nature of Everyday Life', in G.H. Gossen (ed.), *Symbol and Meaning Beyond the Closed Community: Essays in Mesoamerican Ideas* (Albany), 155–72.
- Megas, G.A. 1946. *Θεσσαλικαὶ οικησεῖς* (Athens).
- Palyvou, C. 2005. *Akrotiri Thera. An Architecture of Affluence 3,500 Years Old* (Philadelphia, Pennsylvania).
- Palyvou, C. 2018. *Daidalos at Work: A Phenomenological Approach to the Study of Minoan Architecture* (Philadelphia, Pennsylvania).
- Popham, M.R., Calligas, P.G., and Sackett, L.H. (eds) 1993. *Lefkandi II. The Protogeometric Building at Toumba. Part 2: The Excavation, Architecture and Finds* (London).
- Seeley, I.H. 1980. *Building Technology* (Houndmills and London).
- Shaw, J.W. 2015. *Elite Minoan Architecture. Its Development at Knossos, Phaistos, and Malia* (Philadelphia, Pennsylvania).
- Smith, S. 1983. *Builders' Detail Sheets*. Series 1 and 2 (London).

APPENDIX 5 STRUCTURAL ASPECTS OF THE LEFKANDI-TOUMBA BUILDING

by Igor Kavrakov, Allan McRobie and Alexandra Coucouzeli

INTRODUCTION

Our aim in this Appendix is to conduct a forensic analysis in order to assess the structural integrity of the Lefkandi-Toumba (LK-T) building using simple hand calculations and engineering judgment. Given that we do not have definitive evidence of significant structural failure of the timber frame (such as broken posts, damaged post pits due to racking, collapsed timbers, etc.), we can only postulate hypotheses of potential damage and indicate the most probable ones. Where applicable, we also discuss signs of disturbance or damage in the building (see main article: Introduction).

We will consider the LK-T building in its new reconstruction as proposed here (see main article, with Figs 2-12), which is based on its identification as a timber frame structure, where the construction of the frame would have theoretically preceded that of the walls. The surviving elements of the timber frame were the remains of a series of posts (posts along the walls, veranda posts, as well as centre posts on the long axis of the building), which were embedded in the ground, thus acting as pile foundations, and which supported the thatched roof. The exterior stone-and-mudbrick walls, which were probably in the process of being built, served merely as a protective envelope or cladding for the frame, standing independently of the latter, as evidenced at the west end of the building (see main paper, Figs 9, 12).¹ We will therefore base our analysis on the wooden frame as the load-bearing structural system. However, we will indicate where the exterior walls might have had an influence should they have been completed.

Our primary hypothesis is that wind action is the most likely cause of damage. Indeed, a lightweight, timber frame structure would be expected to be more susceptible to damage by wind loading than earthquake excitation, since earthquake forces are proportional to the structural mass, thus lighter structures experience smaller forces due to their low mass – as a result, timber frame structures have proven to be particularly resistant to earthquakes for millennia around the world.² The wind can induce loads, which can fluctuate both upward and downward, and lighter structures are more susceptible to being uplifted or having components uplifted. Certainly, any modern roof design would have to cater for both possibilities, and it would often be expected that holding the roof down in a gale may prove to be more difficult than holding it up.

Several previous authors considered the possibility of wind being the most likely source of damage or disturbance in the LK-T building. Thus, the excavators, who – it should be noted – considered the building as a structure with load-bearing walls (see main article: Introduction), considered the possibility of structural damage from high winds acting on the roof. They wrote: ‘A high wind would add a significant wind load upon the roof, but the main danger of failure would be from the lifting forces at the eaves, ridge, and gable edges; this would put a considerable strain on the fastenings of beam to beam and thatch to rafter. However, with no firm information either on the exact form of these vulnerable areas and fastenings, the probability of such a failure in practice cannot be calculated. But if some structural damage is needed to explain the rapid burial of the building, then difficulties with the roof are perhaps the most likely.’ (Popham et al. 1993, 48). Calladine, in a personal communication to one of the present authors,³ examined the lateral effects of wind loads on the LK-T building, considering the latter as a timber frame structure. Calladine looked at the possibility of bending failure of the wall- and veranda posts just above ground level and the possibility of overturning of the posts

¹ Since, in most of the building, the walls were closely juxtaposed to the wall posts, it is tempting to think that they would be connected to the timber frame to make the building more rigid. This could be achieved by means of horizontal timbers inset in the mudbrick walls at regular intervals – a system used in the eastern Mediterranean for thousands of years to tie the walls to prevent them from collapsing outwards and which is called *xylodesia* in modern Greek (see Tsakanika 2017, 268-72; 2018, 12); the horizontal timbers could then be connected to the wall posts. However, no evidence of such a system has been found in the walls (at least not up to the maximum preserved height of c. 1.60 m), while at the west end of the building, the distance between walls and wall posts in some places (c. 0.16 m-0.46 m) (main article, Figs 1, 9 and 10) appears to have been too great to allow such a connection.

² See, for instance, Kouris and Kappos 2012; Porcu 2017; Tsakanika 2017; 2018. See also Appendix 1: B.1.III., B.2.2.2, with further references.

³ C. R. Calladine, pers. comm. (see Coucouzeli 1994, 304-5).

due to ‘racking’. We will revisit his analysis here. More recently, an interdisciplinary team from the University of Notre Dame investigated how predominantly downward wind-induced forces on the roof could cause rafters to fail due to the bending or buckling of the centre posts.⁴ Their work was prompted by an article by Herdt (2015), which raised the possibility of buckling of the centre post C4 in the LK-T building due to self-weight. We will examine some of these damage mechanisms and propose new ones that we deem critical for the structure.

Our calculations are based on the following dimensions (see main article, Figs 5, 6, 7; Appendix 3: III; Table A3:1):

Cross-sectional dimensions	
Wall posts, veranda posts	all 0.072 m x 0.22 m (averages)
Centre posts	diameter (ground level) 0.22 m (average)
Rafters	all 0.075 m x 0.15 m (reconstructed)
Ridge beams	all 0.112 m x 0.206 m (reconstructed)
Battens	diameter 0.025 m (reconstructed)
Depth of posts	
Wall posts, veranda posts	all 0.58 m (average) ⁵
Centre posts	all 1.44 m (average)
Height of posts above ground	
Wall posts (+ plates)	all 4.20 + 0.15 = 4.35 m (reconstructed)
Veranda posts (+ plates)	all 1.80 + 0.15 = 1.95 m (reconstructed)
Centre posts (+ ridge beam + rafters on central axis of building)	9.00 m (reconstructed)
Roof dimensions	
Maximum height of roof (to apex, inc. thatching)	9.30 m (reconstructed)
Minimum height of roof (to lowest point of veranda rafter)	1.69 m (reconstructed)
Maximum width of roof (without thatching)	14.40 m (reconstructed)
Intervals in a typical section across the timber frame	
Wall posts, veranda posts, principal rafters	all 1.50 m
Centre posts	all 3.00 m ⁶
Common rafters	all 0.50 m (reconstructed)
Battens	all 0.30 m (reconstructed)

Furthermore, it is reasonable to take the timber to be *Cupressus Sempervirens* (see Appendix 2: I) with the following properties:

⁴ Available online <<https://architecture.nd.edu/news-events/events/2022/05/09/the-toumba-building-at-lefkandi-preliminary-results-of-a-new-architectural-analysis/>> accessed December 2022.

⁵ Note that many of the post depths given by the excavators are in the form ‘[such-and-such] +’, which they explain as indicating they were unable to ascertain the depths of posts below ‘[such-and-such]’. Thus, the actual average depth of the wall- and veranda posts may be greater than 0.58 m.

⁶ The intervals between posts vary (see Popham *et al.* 1993, table 3). As stated in the main article, a typical section across the timber frame is that involving the interval between the central posts C4-C5, equal to 3 meters, to which corresponded two intervals between the wall- and veranda posts on each side, equal to 1.50 m (main article, Fig. 5). Therefore, from a structural point of view, a typical 3.00-metre segment across the timber frame would comprise a single centre post in the middle, and 4 wall posts and 4 veranda posts: on either side of the central post, there are 2 posts (i.e. 1 wall post and 1 veranda post) in line with the centre post + 2 (4 x 0.50) posts on the interface between two 3.00-metre segments (i.e. two halves of wall posts and two halves of veranda posts) = 4 posts.

Bending strength	20 MPa ⁷
Young's modulus along the grain (mean)	9500 MPa ⁸
Young's modulus along the grain (characteristic)	6400 MPa ⁹
Density	530 kg/m ³ = 5.3 kN/m ³ ¹⁰

and to take the soil to have the following properties:

Density	2000 kg/m ³
Angle of internal friction	30 ⁰

These material properties are all very rough, but typical values.

We first outline the basic strategy, before performing a more detailed analysis. Basic engineering analysis consists of defining the load or 'action' and then examining the 'capacity' of the structure under examination to resist that type of action. We will concentrate on the wind actions and the potential failure mechanisms as a consequence of them. The wind is described by first defining the wind hazard on site, which is independent of the structure, and then converting this hazard into load on the structure based on the structural shape.

Structural engineers follow established provisions, i.e. building codes, when designing structures. These building codes contain rules for calculating loads for simplified structural geometries that are based on sometimes decades-long work of specialist groups. We shall largely follow the provisions for wind loads specified in Engineering Sciences Data Unit-(ESDU 82062, 2002) and Eurocode 1 (EN 1991-1-4). Although other codes exist (e.g., American, Australian, Canadian, Japanese) they do not differ greatly.

ANALYSIS

First, in Section I, we will define the wind hazard on the site and then convert this hazard into pressure load on our structure. Then, in Section II, we will examine the 'capacity' of our structure to withstand that load by hypothesising three potential damage mechanisms: uplift of the roof, overturning of the posts acting as pile foundations, and breaking of the rafters. Additionally, in Section III, we will examine other potential causes of damage to the structure, such as an earthquake and the buckling of the centre posts.

I. Wind Hazard on Site

Defining the wind hazard on a site involves estimating the probability of occurrence of a certain wind speed or pressure at a particular height above ground level. This is based on previous records measured at weather stations near the site and the topography of the site.

a. Mean wind speed

⁷ It is difficult to assess the bending strength of wood at a specific location. Although small specimens can be evaluated, bending strength depends on imperfections in the timber along the entire structural element (e.g., beam or column), such as knots, irregular slope of grain, gum veins, etc. For conifers, i.e. softwoods, Eurocode 5 (EN 1995-1-1) and BS EN 338:2003 assign structural timber to 12 grades or strength classes ranging from C14 (weakest) to C50. These classes are based on the mechanical properties and method of production of the timbers; for example, a C14 timber has a bending strength of 14 MPa. In the absence of a systematic study of Cypress wood based on the Eurocodes, we will rather be guided by the comparison with the data for pine. In Europe, pine timber is typically classified into higher timber classes than C24 (see Mirski et al. 2020), indicating a bending strength exceeding 24 MPa. Laboratory results have shown that Cypress is in a better position than Black pine. Additionally, Cypress wood usually has fewer defects (knots, cracks, etc.) than other species and the only thing found more regularly in Cypress is spiral grain. Black pine can be classified in strength classes C18, C24 and C35 (Anastasopoulou and Gouigouis 2018; we are grateful to M. Skarvelis for drawing our attention to this study). Therefore, Cypress wood is (indirectly) better than Black pine and can have a resistance class of at least C24 (M. Skarvelis, pers. comm.). If the LK-T building was built today, a grade C24 timber would likely have been used. However, the technological means for carving wooden sections to precise dimensions differ greatly from those that were available when the building was constructed. Consequently, the uncertainty in obtaining timber elements with less precise and potentially weaker cross-sections would be significantly higher at the time of construction of the LK-T building. To address this uncertainty and be on the conservative side, it is reasonable to assume a C20 timber grade, with a bending strength of 20 MPa.

⁸ Mean Young's modulus for timber grade C20 according to BS EN 338:2003. This value is used to estimate the stiffness of the timber frame for the earthquake analysis (see *infra*, Section III.a).

⁹ Characteristic (i.e. 5-percentile) Young's modulus for timber grade C20 according to BS EN 338:2003 (i.e. 5% of the C20 samples tested have a Young's modulus less than 6400 MPa). The characteristic value is used when estimating buckling resistance (see Section III.b) according to Eurocode 5 (EN 1995-1-1, clause 6.3.1.).

¹⁰ See Table A2:1 for *Cupressus sempervirens* (similar density for Pine timber in Europe – see Mirski et al. 2020).

A primary metric for the wind hazard on site is the mean wind speed, averaged over a certain time, and with a particular return period T . Building codes stipulate averaging times at either 10 minutes or 1-hour intervals. Within that interval, there will be gusts at velocities considerably greater than the mean wind speed, due to the inherently turbulent nature of the wind. The code provides a gust factor, which will convert these pressure averages into the peak gust values that need to be designed for. This can more than double the pressure. The return period is the average time between storms with particular wind-speed magnitudes.

The mean wind speed U is usually specified in building codes or it can be estimated based on recorded wind speeds at weather stations using extreme value analysis. In other words, we take the historical continuous data on-site and we employ statistical methodologies to estimate the mean wind speed U for a chosen return period, which we will decide later.

In our study, we used historical data on the mean wind speed provided to us by the Athens National Observatory (NOA) Near the LK-T building site, there are three weather stations that could be considered as representative: Aulis, Chalcis, and Tanagra (see Fig. A5:1).¹¹ Of these, we chose the stations of Chalcis and Tanagra. Both are located on relatively open terrain: the former is on a hill, above the neighbouring town of Chalcis, the latter on the airport of the nearby town of Tanagra, which ensures that no surrounding buildings influence the wind field. The weather station of Aulis was excluded, because it is located on top of a low-rise building, and it is suspected that the data is influenced by the local aerodynamics of obstacles, in turn influencing the measured wind speed.¹²



Fig. A5:1. Satellite image of the Lefkandi-Toumba site and the three nearby weather stations of Aulis, Chalcis, and Tanagra (Source: Google Maps).

The data are recorded at 5 metres above ground and are available in continuous records of 1-hour mean wind velocities for the following periods:

Chalcis: from 19.01.2011 to 01.01.2022

Tanagra: from 29.05.2009 to 01.01.2022.

At times, the anemometer did not measure the wind, due to various issues (e.g. power disturbance). These non-measurements were disregarded from the analysis.

The statistical analysis was performed using Cook's method of independent storms (Cook 1982), which is also the fundamental method used in standardised documents and codes such as that of the ESDU. The method initially consists of selecting independent storms and determining the maximum 1-hour mean wind speeds during these storms. We find storms as events for which the average 10-hour wind speed is larger than 6 m/s or 22.6 km/h. This gives us 1-hour mean wind speeds for each of these independent storm events (denoted as N_s – number of events) from the data. We can then sort these events in ascending order based on the wind speed and calculate the probability of occurrence $P(U)$ of a wind speed lower than or equal to U as:

¹¹ K. Lagouvardos, pers. comm.; Lagouvardos et al. 2017; C. Varotsos, pers. comm.

¹² K. Lagouvardos, pers. comm.

$$P(U) = \left(\frac{m_s}{N_s + 1} \right)^r,$$

where m_s is the index of the storm, based on the ascending order of data starting from $m_s = 1$ for the storm with the lowest wind speed up to $m_s = N_s$ for the storm with the highest wind speed. The coefficient $r = N_s/T_{data}$, where T_{data} is the period in years for which we obtained the data (10.96 years for Chalcis and 14.46 years for Tanagra). We identified $N_s = 376$ storms for Chalcis and $N_s = 190$ storms for Tanagra.

Having for each storm the maximum hourly wind speed, and the corresponding probability of its occurrence $P(U)$, we can represent the data on a plot using the reduced variate defined through the natural logarithm (ln):

$$y = -\ln(-\ln P(U)).$$

The representation of the data is depicted in Fig. A5:2 (left), in graph that have the reduced variate on the horizontal axis and the hourly wind speed on the vertical axis. We can observe that the reduced variate and the data are generally related linearly.

We can also represent the data based on the return period T :

$$T = \frac{1}{1 - P(U)},$$

as depicted in Fig. A5:2 (right).

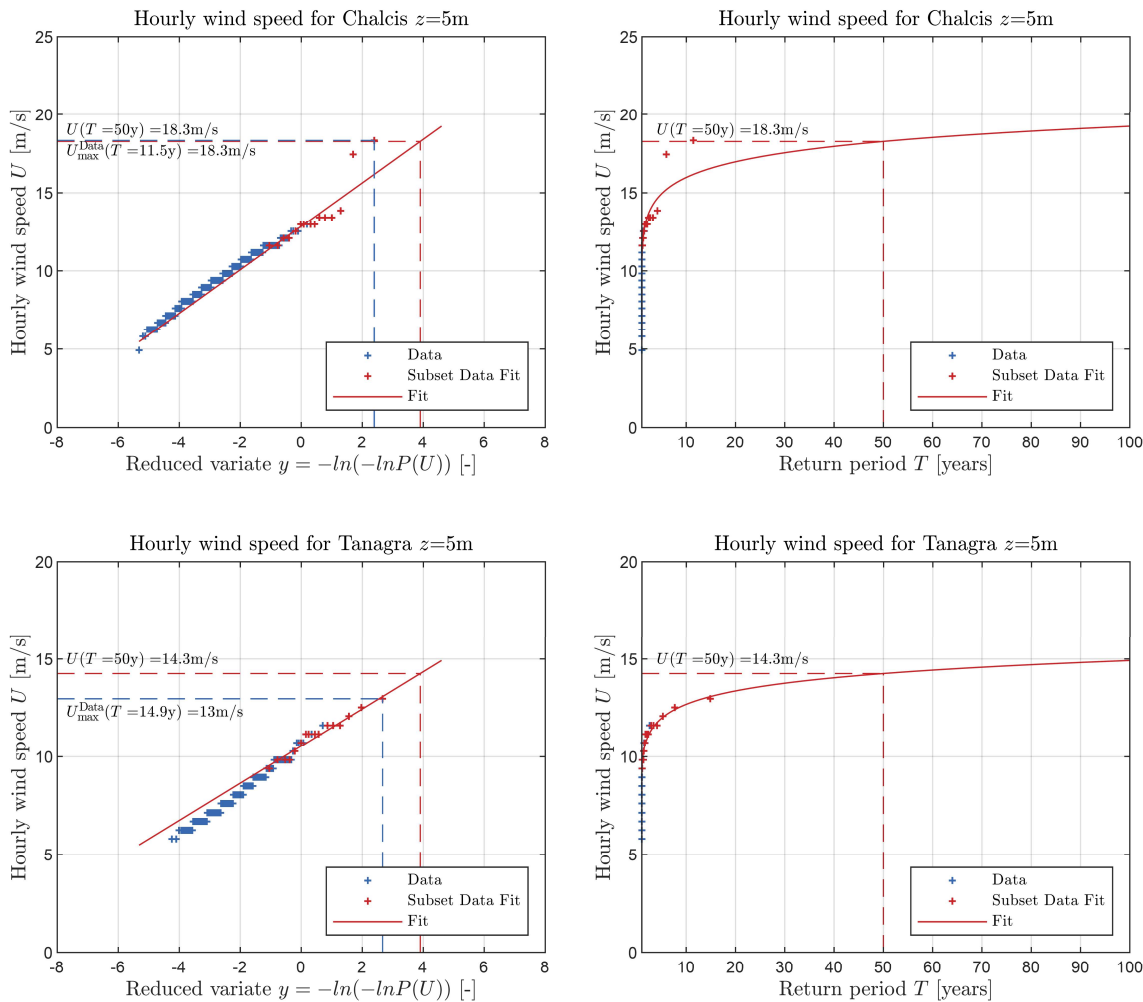


Fig. A5:2. Hourly wind speed for the Chalcis (top) and Tanagra (bottom) weather stations as a function of the reduced variate y (left) and return period T (right).

If we would like to estimate the mean wind speed for a return period for which we do not have sufficient data, we could do so by fitting a linear curve to the data on the left plot. The fitting is weighted, i.e. the data points at higher wind speeds are with higher weights, since the data is scarce in this region. This linear function

can also be represented in terms of Return Period vs Hourly Wind Speed and we can estimate the hourly mean wind speed for any return period.

In this case, we select a return period of 50 years, which means that there is a 2% chance that the calculated average wind speed occurs in any given year. Whilst using a 50-year return period wind may seem a rather extreme case to consider, it should be borne in mind that there is a difference between design and forensic analysis. A designer would take the 50-year gust-factored pressure and apply a further ‘load factor’, typically of the order of 1.5, and then design the building so that it does not collapse at that value. In forensic analysis, there is no such ‘load factor’; thus, if we conclude that the LK-T building would be likely to collapse at the 50-year event, it does not mean that it complies with modern design standards. Far from it! A modern building should have a very small probability of collapsing under the 50-year wind speed, because of the use of the extra safety factor, the ‘load factor’, which may increase the design loads by a further 1.5. In the analysis here, the general strategy will be to determine whether the LK-T building is likely to withstand a once-in-50-year event.

b. Influence of the terrain and boundary layer statistics

The mean wind speeds that we calculated for the weather stations of Chalcis and Tanagra are at a fixed height of 5 metres. However, the mean wind speed increases with height above the ground surface. This variation of the mean wind speed with respect to height, called mean wind profile, is very much dependent upon the terrain characteristics upwind. A smooth terrain, such as a sea surface, can mean that there may be a fast convergence of the mean wind speed towards a constant high mean velocity with smaller gust fluctuations. A rougher terrain, such as a cityscape, could correspond to lower mean velocities but much higher gust factors due to the increased turbulence.

The Chalcis weather station is on the top of a hill that is somewhat isolated; therefore, the terrain around it is assumed to be an ‘Area with low vegetation such as grass and isolated obstacles (trees, buildings) with separations of at least 20 obstacle heights’ (Terrain Category II – Eurocode 1 (EN 1991-1-4), table 4.1) or, similarly, ‘A farmland with few/isolated trees’ (ESDU 82026, 2002, table 13.1). The corresponding roughness length is $z_0 = 0.05$ m. The Tanagra weather station is on an airport near the town and therefore the terrain will be assumed as an ‘Area with a regular cover of vegetation or buildings or with isolated obstacles with separations of maximum 20 obstacle heights (such as villages, suburban terrain, permanent forest)’ (Terrain Category III – Eurocode 1 (EN 1991-1-4), table 4.1) or, similarly, ‘Fairly level wooded country: Many trees, hedges, few buildings’ (ESDU 82026, 2002, table 13.1). The corresponding roughness length is $z_0 = 0.3$ m. This parameter will set how the wind profile develops and how turbulent the wind is. Note that the direction of the wind also plays a role; however, due to insufficient wind data, we disregard its influence and assume that the terrain is uniform in all directions, which of course is not the ideal case.

Following the so-called logarithmic law for the assumed roughness length z_0 , the mean wind profile varying with respect to height above ground z is:

$$U(z) = 2.5u^* \ln z/z_0,$$

where u^* is the friction velocity that is based on our 50-year wind velocity at $z = 5$ m above ground and is obtained from the measurements in our previous section (see ESDU 82026, 2002 for details for this friction velocity). The mean wind profile for the Chalcis and Tanagra stations, and the corresponding mean wind profiles at the lowest (1.69 m) and highest (9.30 m) elevations of the (reconstructed) roof of the LK-T building, are shown in Fig. A5:3 (left).

The wind field is however turbulent as it carries turbulent structures or ‘eddies’ as a result of changes in the terrain due to surface roughness. These ‘eddies’ or ‘gusts’ manifest themselves in the transient wind speed as sudden increases in velocities that typically last a few seconds. This sudden high wind speed, commonly termed gust- or peak wind speed, is governing when we calculate the structural capacity. In other words, we design modern structures to sustain a short-lived gust, typically a ‘3-second gust’.

We can estimate the gust wind speed U_g by adding to the mean wind speed around 3.5 times the standard deviation of the gust fluctuations:

$$U_g = U_m + 3.5\sigma_u.$$

This exact number 3.5 tells us that the gust wind speed we consider as a peak is higher than 99.9% of the velocities that would appear in a certain interval (until now, this interval is one hour), if we consider the fluctuations to be Gaussian in time – a standard assumption in wind engineering. The standard deviation of

the fluctuations or its normalized version called the turbulence intensity $I_u = \sigma_u/U_m$ is a measure to quantify the turbulence of the wind fluctuations. To compute the turbulence intensity I_u and its variation with respect to the height above ground, based on the friction velocity, terrain roughness and Coriolis force, we used ESDU (85020, 2001). Without going into detail about how the turbulence intensity is obtained, we note that the turbulence intensity at 5 metres above ground for the Chalcis and Tanagra stations is 0.207 and 0.210, respectively. In other words, the standard deviation of the gust fluctuations for the Chalcis and Tanagra stations is 20.69% and 21.05% of the mean wind speed, respectively.

The gust wind speeds obtained as described above for the Chalcis and Tanagra stations, and the corresponding values at the lowest and highest elevations of the (reconstructed) roof of the LK-T building, are shown in Fig. A5:3 (right).

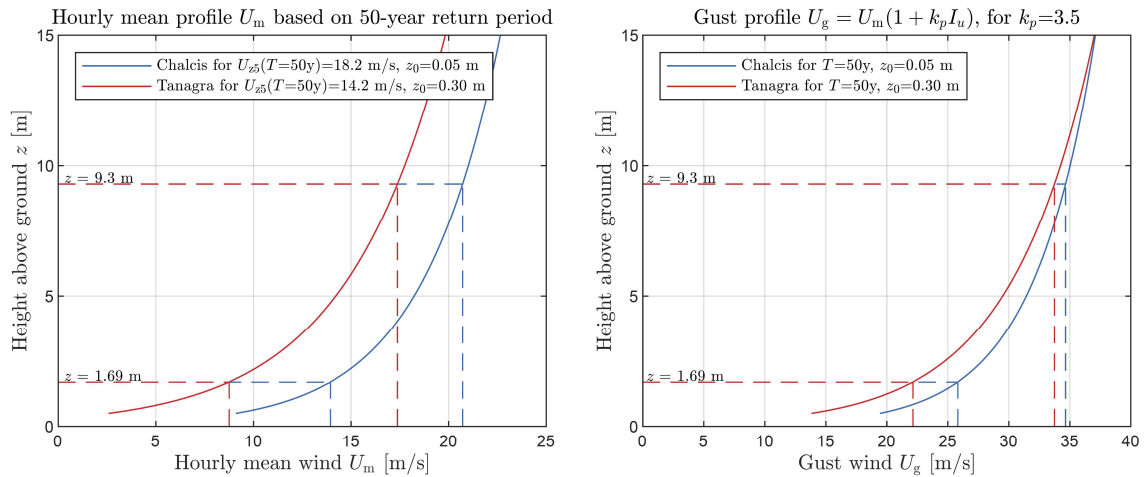


Fig. A5:3. Boundary layer of hourly mean (left) and gust wind speed (right) for a return period of $T=100$ years. The dashed lines indicate the lowest and highest elevations of the (reconstructed) roof of the LK-T building.

The *wind loading pressure* acting on a structure is directly related to the *wind velocity pressure* due to the wind. We can calculate a mean velocity and a gust velocity pressure, depending on the wind speed that we use. The peak velocity pressure, which is the most relevant parameter for calculating the loading pressures acting on the structure, can be calculated based on the peak wind velocity as:

$$q_p = \frac{1}{2} \rho (k U_g)^2,$$

where ρ is the density of the fluid (in our case, air density $\rho = 1.2$ kg/m³). When designing a structure, we commonly work with the 10-minute pressures that we translate into forces; therefore, we use a factor of $k = 1.06$ to convert the hourly mean velocity into a 10-minute velocity. Fig. A5:4 depicts the mean velocity pressure profile (left) and the peak velocity pressure profile (right), respectively, for the Tanagra and Chalcis stations, and the corresponding values at the lowest and highest elevations of the (reconstructed) roof of the LK-T building.

Our analysis determines the wind hazard on site based on meteorological data. Since, however, the usual design practice in engineering is to rely on specifications contained in building codes, which are typically more general and conservative, we have also calculated the code-based wind velocity pressures based on the Greek national annex of Eurocode 1 (EN 1991-1-4). Therein, two main zones for wind hazards are specified: coastal and inland zones. Euboea is considered coastal; therefore, the ‘basic’ (mean) wind velocity is 33 m/s at a 10-metre height and the associated velocity pressure is 0.68 kPa. These values may be reduced to account for the orography and seasonality; however, we will not take these factors into account. Assuming a roughness of $z_0 = 0.05$ m, i.e. that of Chalcis (*supra*) for reasons that will be clarified presently, we have calculated and shown on Fig. A5:4, the mean velocity pressure profile (see Eurocode 1 (EN 1991-1-4), Sections 4.2 and 4.3 for details) (Fig. A5:4 left) and the peak velocity pressure profile (see Eurocode 1 (EN 1991-1-4), Sections 4.4 and 4.5 for details) (Fig. A5:4 right), as well as the corresponding values at the lowest and highest elevations of the (reconstructed) roof of the LK-T building.

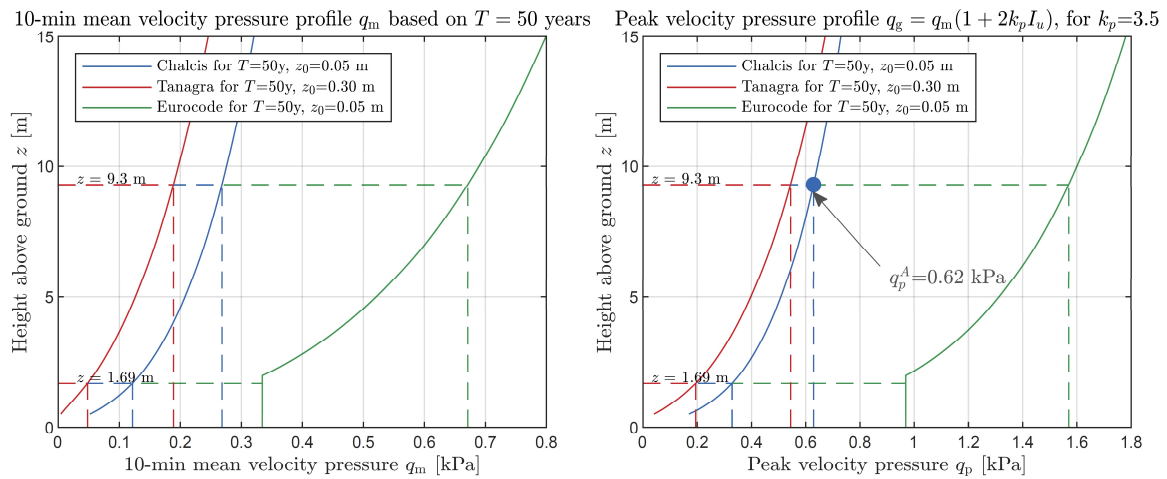


Fig. A5.4. Boundary layer of 10-min mean (left) and peak velocity pressure (right) for a return period of $T=50$ years. The dashed lines indicate the lowest and highest elevation of the (reconstructed) roof of the LK-T building. The peak action velocity pressure q_p^A is taken as a governing action.

While we could consider different peak velocity pressures at different heights of the roof when later calculating the loading pressure on the building, Eurocode 1 (EN 1991-1-4) stipulates to consider the velocity pressure at the top when looking at the roof. This is a simplification, which takes into account the correlation of the wind gusts as well as how much of the gust is ‘admitted’ to the roof. In the case of the meteorological data, we have two values for the peak velocity pressures at the top of the (reconstructed) roof of the LK-T building: 0.62 kPa for Chalcis and 0.54 kPa for Tanagra. Although quite similar, these two values differ from each other probably due to terrain effects, as the Tanagra station is located at an airport near the town, while the Chalcis station is located on a hill. We will base our analysis on the Chalcis peak velocity pressure, since we assume that there were fewer human-made obstacles at the LK-T site in ancient times. We will consider this velocity as the governing ‘action’, i.e. the *peak action velocity pressure* that needs to be resisted:

$$q_p^A = 0.62 \text{ kPa} \approx 62 \text{ kg/m}^2.$$

We will keep this value as a reference of the action and later we will discuss what it means. The Eurocode 1 peak velocity pressure results in a significantly higher value of 1.55 kPa. Eurocode 1 is probably conservative, since there is one general value for the complete coastal area of Greece (e.g. similar wind speed on Crete and Euboea), and the effects of orography are not taken into account. We will base our forensic analysis on the meteorological data, while however keeping in mind the much higher peak velocity pressures that a structural engineer would use to design a building.

These are the values that describe the wind hazard and the ‘action’ of the wind on the LK-T site. All that remains now is to determine the ‘capacity’ of our structure to resist this type of action.

II. Aerodynamic Analysis and Potential Causes of Wind-induced Damage to the Building

Having established the peak velocity pressure, we can now determine the pressure coefficients c_p based on the geometry of the LK-T building to calculate the peak *capacity velocity pressures* (i.e. how much of the velocity pressure is admitted as loading pressure) and compare them to the action on site.

The wind velocity pressure can act on both the external and internal surfaces of buildings. Loosely speaking, wind pressure can enter a building through any openings (such as doors, windows, or eaves gaps), and these together with overhangs and verandas can further increase the chance that the roof will be lifted upwards and off. The values of the pressure coefficients for a particular building geometry can be determined i) experimentally at full scale or wind tunnel model scale; ii) computationally, using various Computational Fluid Dynamics codes, and iii) from building code recommendations. We shall use the latter, as the geometry of the LK-T building is fairly regular and for such geometry there are plenty of experimental data, while the computational methods have their disadvantages, especially when it comes to correctly modelling peak gust effects rather than long-term averages.

The values of the pressure coefficients c_p are well codified for simple building geometries in building codes. Eurocode 1 (EN 1991-1-4) contains pressure coefficients c_p for a broad range of building geometries.

These are the embodiment of many years of research, backed by monitoring the results of their use in design practice. However, the set of geometries cannot be exhaustive, and there is no codified example that exactly matches the geometry of our building.

We consider the external pressure coefficients c_p that relate to the wind pressures experienced on the outer surface of the LK-T building. The closest matching geometry is a duo-pitch roof with roof slope $\alpha = 45\text{deg}$, according to the reconstruction of the building proposed here (main article, Fig. 7). Coefficients are tabulated for wind incident perpendicular to the long side (lateral direction, $\theta = 0\text{deg}$) (Eurocode 1 (EN 1991-1-4), table 7.4a) and to the short ends (longitudinal direction, $\theta = 90\text{deg}$) (Eurocode 1 (EN 1991-1-4), table 7.4b) of a building with two gable ends. We have examined these two cases, taking the incident wind to the short end to be perpendicular to the east, gable end of the LK-T building. The two cases are sketched in Fig. A5:5, considering a representative part of the building for each case (shown in grey in the figure).

Note that for the winds perpendicular to the building's long side (lateral winds), the pressure coefficients are comparatively mild, around $+0.65$ on the windward slope and around -0.25 on the leeward slope, that is, the windward pressures are exerted downwards and the smaller, leeward pressures are trying to cause an uplift (Fig. A5:5 bottom). The comparative mildness of these values can be gauged by comparing them with a duo-pitch roof with roof slope $\alpha = 30\text{deg}$: whilst the downward pressures are similar to the 45-degree case, there are uplift coefficients of -1.5 which should be applied when designing small areas on the windward slope. The immediate conclusion is that a 45-degree roof pitch is a far better design than a 30-degree roof pitch.

For the 45-degree roof pitch, it is the $\theta = 90\text{deg}$ winds that blow perpendicular to the short end and along the length of the building (longitudinal winds) that are more problematic for the roof construction itself: there is uplift across the whole or the representative part of the roof, with high upward pressures at the upwind end of the building, where pressure coefficients vary from -1.6 to -0.5 on elements that support large areas of the roof (of more than 1 m^2) or, even more extreme, from -2.0 to -0.5 , on elements that support small areas of the roof (of around 1 m^2) (Fig. A5:5 top).

Further, internal pressure coefficients from various openings (such as a gable opening, which was probably not yet closed and a wide entrance opening at the façade), a large roof overhang over the Porch, and a veranda roof built as an extension of the main roof of the building¹³ would have increased the uplifting pressure. We will not consider them presently; however, a note will be made where these can influence our analysis.

We can now proceed to calculate the resistance of the LK-T timber structure by hypothesising three potential damage mechanisms, i.e. (1) uplift of the roof, (2) lateral bending and overturning of the frame, and (3) breaking of the rafters, and commenting on how probable they are. We characterise the resistance by the *peak capacity velocity pressure* q_p^R at the top of the roof, which can be obtained based on the resistance forces for each damage mechanism. In order for damage or failure not to occur, this pressure needs to be higher than the *peak action velocity pressure* $q_p^A = 0.62\text{ kPa}$ for the Chalcis station (*supra*). Simple hand calculations are used to argue the likely causes for potential damage.

¹³ Reconstructed dimensions of gable opening at the east end of the building: height = 4.016 m; base = 8.034 m (see main article, Fig. 8). Entrance opening at the east end of the building: width = 5.175 m (cf. Popham et al. 1993, 10: 'nearly 5 m wide'); (reconstructed) height = 4.27 m (main article, Figs 3, 8). Roof overhang at the gabled eastern end of the roof, over the Porch: (reconstructed) width = 1.82 m (main article, Fig. 6); this is much larger than the recommended roof overhang of $<0.45\text{-}0.50\text{ m}$ (see, e.g., Lotay 2015, 40, 44-45, 52, 57-58). Veranda roof built as an extension of the main roof of the building: see main article, Figs 7-9.

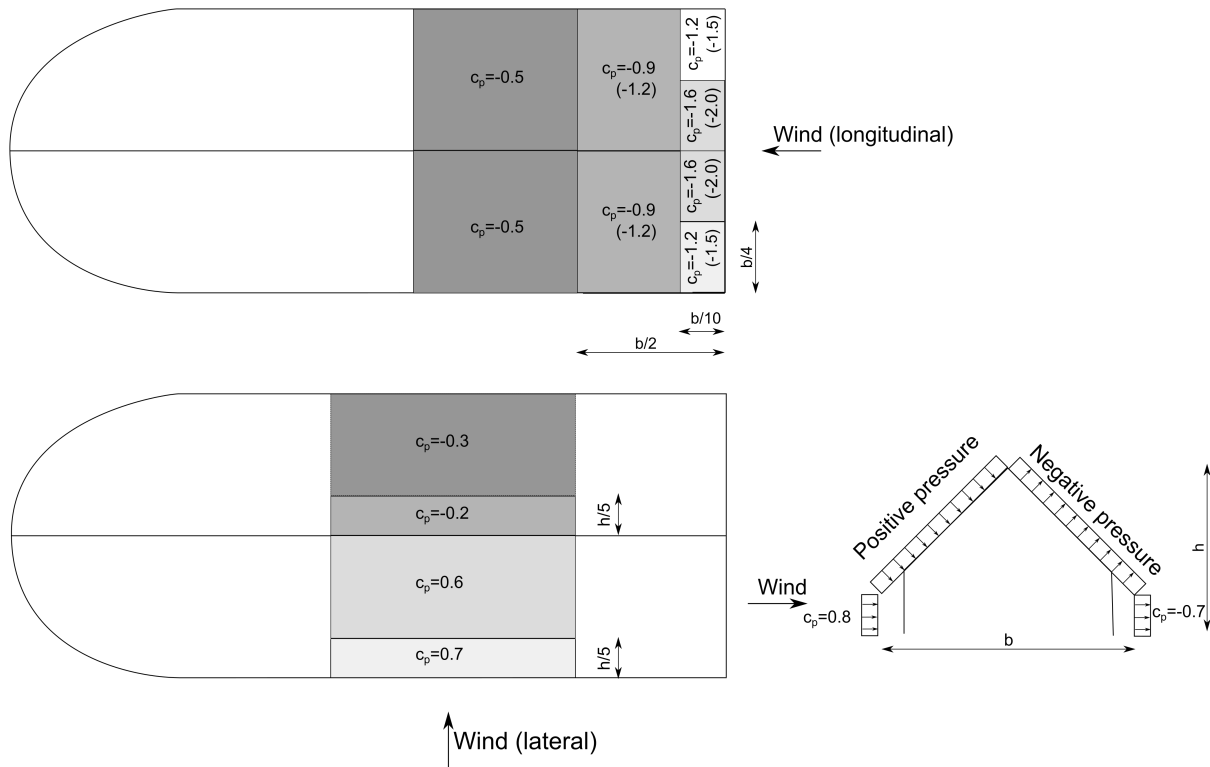


Fig. A5:5. External pressure coefficients according to Eurocode 1 for wind perpendicular to the short end of the LK-T building (top) and to the long end of the building (bottom). The values outside of brackets are for elements with an area of 10m^2 , while the values inside brackets are for elements of 1m^2 . Drawings not to scale.

a. Uplift of the roof

Even before any detailed calculations commence, it can be discerned that wind uplift may prove problematic: in Europe, it is common to design buildings to withstand wind pressures of the order of 1kPa , and with even higher values possible in local areas, near the corners of the buildings. For the LK-T building, the self-weight of the thatch, made of reeds, is estimated to be $q_t = 50\text{ kg/m}^2$ (Hall 1988, 10) measured along the slope, which is around 0.71 kPa downward on a horizontal plane.

We examine three possible scenarios of uplift damage for a representative (typical) 3.00-metre segment of the roof between centre posts:¹⁴ (a) damage to an area of 1 m^2 and uplifting of the thatch; (b) uplifting of the roof; and (c) uplifting of the entire timber frame.

For $\theta = 90\text{deg}$, the area up near the ridge line above the windward gable, the minimum external pressure coefficient is -2.0 when considering the effect of correlation over small areas (see Fig. A5:5 top, values in brackets). This is the smoking gun. The self-weight of the thatch over the horizontal area being equal to $c.0.71\text{ kPa}$ (*supra*), the peak capacity velocity pressure is:

$$q_p^R = 0.71 / 2.0 = 0.355\text{ kPa}.$$

The peak action velocity pressure $q_p^A = 0.62\text{ kPa}$ for the Chalcis station (*supra*) is almost double this value. This is more than enough to overcome the self-weight of the thatch and cause the ties attaching the thatch to the battens and the battens to the rafters to break.

In the unlikely event that the ties attaching the thatch to the roof frame did not break, we can calculate the uplift capacity velocity pressure that the roof could have sustained, assuming that connections between the roof and the posts were not sufficiently tight to resist the pressure.¹⁵ The capacity loading pressure q_l of the first roof segment due to uplift is obtained by scaling the capacity velocity pressure with the external pressure coefficients and corresponding regions per unit area based on a segment of $3.00\text{ m} \times 14.40\text{ m}$ (see Fig. A5:5 top, values outside brackets):

¹⁴ See Introduction.

¹⁵ According to the reconstruction of the building put forward here, the roof was simply supported: while the king posts would be tenoned into the crossbeams, there would be no actual connections between the rafters and the ridge beam(s) over the centre posts or between the rafters and the plates over the wall- and veranda posts, as is common practice in timber-framed buildings using squared timbers connected by means of carved joints, (without use of lashings) and relying on the self-weight of the roof elements (see main article, with Figs 7, 8, 9, 11, 12; Appendix 1, *passim*; Appendix 3: III, IV).

$$q_l = q_p^R \times \frac{2 \times \left(\frac{14.4}{4} \times \frac{14.4}{10} \times 1.2 + \frac{14.4}{4} \times \frac{14.4}{10} \times 1.6 + \left(3 - \frac{14.4}{10} \right) \times \frac{14.4}{2} \times 0.9 \right)}{14.4 \times 3} = 1.14 q_p^R.$$

The total weight per unit area, consisting of thatch, battens, ridge beam, and rafters, is:

$$q_w^r = \underbrace{\frac{0.5}{\cos(45^\circ)}}_{\text{thatch}} + \underbrace{\frac{3}{0.5} \times \frac{0.075 \times 0.15 \times 5.3 \times \frac{14.4}{\cos(45^\circ)}}{14.4 \times 3}}_{\text{rafters}} + \underbrace{\frac{0.1 \times 0.2 \times 5.3 \times 3}{14.4 \times 3}}_{\text{ridge beam}} + \underbrace{\frac{14.4}{0.3} \times \frac{0.025^2 \times 3.14 \times 5.3 \times 3}{4 \times 14.4 \times 3}}_{\text{battens}},$$

$$q_w^r = 0.89 \text{ kPa.}$$

The peak capacity velocity pressure that the weight of the roof provides is:

$$q_p^R = \frac{q_w^r}{q_l} = \frac{0.89}{1.14} = 0.78 \text{ kPa.}$$

Although this value is higher than the 50-year peak action velocity pressure $q_p^A=0.62$ kPa recorded in the Chalcis station, it is still very close. Today, in garages, the roof is typically tied down to the foundations to counter such uplift.

Let us now calculate the capacity velocity pressure that is required to hold the complete timber frame down. If we assume that the soil friction of the posts is not significant, only the remaining weight of the posts needs to be added to the roof weight q_w^r to calculate the total weight q_w^t per unit area that counters the lift:

$$q_w^t = \underbrace{q_w^r}_{\text{roof}} + \underbrace{\frac{0.22^2 \times \pi \times 5.3 \times (9.0 + 1.44)}{4 \times 14.4 \times 3}}_{\text{centre post}} + 2 \times 2 \times \frac{0.22 \times 0.72 \times 5.3}{14.4 \times 3} \left(\underbrace{\frac{4.35 + 0.58}{\text{wall posts}}}_{\text{wall posts}} + \underbrace{\frac{1.95 + 0.58}{\text{veranda posts}}}_{\text{veranda posts}} \right)$$

$$q_w^t = 1.00 \text{ kPa.}$$

The action stays the same, so the capacity velocity pressure that the total weight of the timber frame provides is:

$$q_p^R = \frac{q_w^t}{q_l} = \frac{1.00}{1.14} = 0.88 \text{ kPa.}$$

This is more than what was obtained for the peak action velocity pressure recorded in the Chalcis station ($q_p^A=0.62$ kPa). However, it is still very close, because in typical design situations, we would use a partial safety factor of 1.5 to increase the peak action velocity pressure to cater for the uncertainties in the wind load, which could come from various sources – both epistemic and aleatoric.

All three of these cases can somehow be considered as a non-conservative estimate since we have not even taken into account the potential internal pressure coefficients. As already mentioned, a gable opening probably not yet closed, a wide entrance opening and a large roof overhang at the façade of the building, as well as the veranda would have created additional uplift forces due to the internal pressures. Moreover, such uplift forces would have intensified if there was an additional hole in the thatch due to local failure. This would make an even stronger case of the uplift of the roof as a failure or damage mechanism.

In summary, the external pressure coefficients alone provide ample evidence in favour of the hypothesis that wind uplift would have presented a severe problem for the timber structure of the LK-T building.

b. Lateral bending and overturning of the frame

As pointed out by Calladine,¹⁶ the resistance of the LK-T timber frame to lateral wind forces comes entirely from the posts, which are buried in the ground and act as pile foundations. It may seem strange that the wall- and veranda posts are in the form of ‘planks’ set parallel to the exterior walls; they might be rather too flexible in bending under forces (Fig. A5:6 left) produced by the wind.¹⁷ However, this orientation is useful from the point of view of a ‘spade’ stuck into the ground: the width of the blade enables the earth to provide a good resistance to overturning. Calladine poses the following question: ‘Suppose the force F was increased steadily.

¹⁶ C. R. Calladine, pers. comm. (see Coucouzeli 1994, 304-5).

¹⁷ For such objections, see Fageström 1988, 60; Popham et al. 1993, 47. Planks 0.025m thick and 0.15 m wide were used for lateral posts in houses at Neolithic Anza IV in central Balkans (Treuil 1983, 249 n. 6 with refs.).

Would the ‘plank’ break at X-X or would the ‘plank’ stay intact while the soil failed causing the ‘plank’ to overturn?.

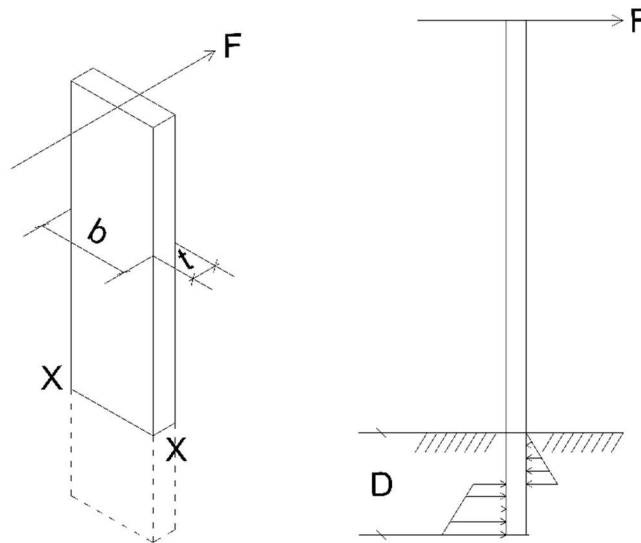


Fig. A5:6. Lateral wind forces acting on a buried plank-like post (left) and soil pressure as a reaction to lateral wind force acting at the top of a plank-like post (right) (based on drawings kindly provided by C. R. Calladine)

Here, we revisit Calladine’s calculation with our updated dimensions and assumptions on the material and discuss three possible scenarios for damage to the pile foundations: (a) bending failure; (b) overturning without temporary wall surfaces; and (c) overturning with temporary wall surfaces. By ‘temporary wall surfaces’ we mean a temporary cover placed between the wall posts prior to the construction of the exterior walls.

Starting with bending failure (scenario (a), *supra*), elementary Soil Mechanics shows that the pressures exerted by the soil on the ‘plank’ are proportional to the distance below the ground surface. They act in the directions shown in Fig. A5:6 (right) in order to provide a moment to resist the lever effect of force F .

The lateral soil pressure is equal to 3 (when the angle of internal friction = 30°) times the vertical stress in the soil due to its own weight.

The overturning moment-capacity M_s of a plank-like post of width b_p buried to depth D is given by:

$$M_s = 60D^3b_p,$$

where the dimensions are in metres.

The bending strength capacity M_b of the plank-like, rectangular post is given by

$$M_b = \frac{\sigma b_p t_p^2}{6},$$

where σ is the yield strength of the wood and t_p is the thickness of the post. A circular post, such as a centre post on the long axis of the building, has a slightly different bending strength, depending on the diameter d_p :

$$M_b = \frac{\sigma \pi d_p^3}{32}.$$

Thus, we obtain:

Moment overturning capacity of a post:

- for the wall- and veranda posts: $M_s = 0.58^3 \times 0.22 \times 60 = 2.56$ kNm

- for the centre posts: $M_s = 1.44^3 \times 0.22 \times 60 = 39.42$ kNm.

Bending strength capacity of a post:

- for the wall- and veranda posts: $M_b = 20,000 \times 0.22 \times 0.072^2 / 6 = 3.08$ kNm

- for the centre posts: $M_b = 20,000 \times 3.14 \times 0.22^3 / 32 = 20.90$ kNm.

We proceed with the calculation of the total capacity force due to bending and overturning. The capacity force F provided by the soil is given by:

$$F = \frac{M}{h_p},$$

where h_p is the height of a post above ground. To calculate the total capacity force that can be resisted by the frame when the wind is acting only on the posts without the roof, we consider the typical 3.00-metre segment across the timber frame (*supra*) as a ‘module’ repeated all along the building. Thus, we obtain the total capacity force by superimposing the capacity forces of 1 centre post and 4 wall posts and 4 veranda posts.

In case of overturning, the capacity force is:

$$F_s = \underbrace{\frac{39.42}{9.0}}_{\text{centre post}} + 4 \times \underbrace{\frac{2.56}{4.35}}_{\text{wall posts}} + 4 \times \underbrace{\frac{2.56}{1.95}}_{\text{veranda posts}} = 12.03 \text{ kN},$$

and in case of bending, the capacity force is:

$$F_b = \underbrace{\frac{20.90}{9.0}}_{\text{centre post}} + 4 \times \underbrace{\frac{3.08}{4.35}}_{\text{wall posts}} + 4 \times \underbrace{\frac{3.08}{1.95}}_{\text{veranda posts}} = 13.61 \text{ kN}.$$

A lower overturning capacity compared to the bending capacity indicates that the principal threat to the timber frame would arise from lateral wind forces sufficient to cause the soil to fail, and not from snapping of any posts. Although we made necessary assumptions on the soil properties and the bending strength of the timber,¹⁸ this is a noteworthy result since it makes sense of the curious (to the modern eye) longitudinal orientation of the wall- and veranda posts: it was in context correct to orient them ‘spade’-wise to maximise resistance to soil failure, rather than perpendicular to the long axis of the building to resist snapping.

It is interesting to remark how much strength, F , against soil failure is contributed by the veranda posts. This shows that, from an engineering point of view in this building, it was appropriate to provide the veranda posts with a depth below ground as great as that for the wall posts, rather than, as one might intuitively suppose, a similar depth: height-above-ground ratio. Even a small increase in the depth of the veranda posts would have had a greater impact on the overall structural strength of the timber frame than the same increase would have had if applied to the wall posts (because these last were taller); it is thus clear that, in order to add extra stability to a given structure of this general design, the thing to increase is the post depth of the veranda posts, which is not immediately obvious.¹⁹ Furthermore, the veranda acted as side aisles to the building and was used as yet another method of ensuring the structural equilibrium of the frame and its resistance to wind forces (see Appendix 1: A.2, Fig. A1:6a). As a solution to the problems of resistance to wind loads and of structural strength and balance of a large-scale timber frame, the veranda arrangement thus has much to recommend it. Therefore, the veranda of the LK-T building, which is a forerunner of the peristyle of Greek temples, was a vital structural component of the timber frame and was not purely present for reasons of protection against the rain or the sun, or even for reasons of aesthetics, impressiveness, or prestige. Of course, our analysis follows a simplified approach, since it is considered that all posts contribute equally to the resistance to the lateral wind force, despite having different bending stiffness; however, it is deemed sufficient for our discussion.

Next, we determine the peak capacity velocity pressure q_p^R as for the uplift previously, based on total capacity force F_s . First, we consider the case of overturning without temporary wall surfaces (scenario (b), *supra*). This means that the open spaces between the wall posts were not temporarily covered, and the wind could blow through them, and therefore the only surface on which the wind acted was the roof.

To do so, we calculate the wind force acting on the roof as a function of the peak capacity pressure. The wind is blowing laterally to the building. As previously, the horizontal wind force is obtained by multiplying the capacity velocity pressure with the pressure coefficients (see Fig. A5:5 at $\theta = 90\text{deg}$) and their

¹⁸ The assumed C20 timber class has a characteristic bending strength of 20 MPa (i.e. 5% of the C20 samples tested have a strength of less than 20 MPa).

¹⁹ This section is based on information kindly provided by C. R. Calladine (see Coucouzeli 1994, 305-6).

corresponding projected areas. The total wind force acting on a 3.00-metre segment of the roof, which is 14.40 m wide, is:

$$F_l^{roof} = q_p^R \times 3 \times \left(\underbrace{\frac{9.0}{5} \times 0.7 + \left(\frac{14.4}{2} - \frac{9.0}{5} \right) \times 0.6}_{\text{windward side}} + \underbrace{\frac{9.0}{5} \times 0.2 + \left(\frac{14.4}{2} - \frac{9.0}{5} \right) \times 0.3}_{\text{leeward side}} \right)$$

$$F_l^{roof} = 19.44 q_p^R.$$

The capacity velocity pressure provided by the resistance of the piles due to overturning is:

$$q_p^R = \frac{F_s}{F_l^{roof}} = \frac{12.03}{19.44} = 0.62 \text{ kPa},$$

which is less than the 50-year action velocity pressure recorded at the Chalcis station ($q_p^A=0.62$ kPa) – we discuss the implications of this at the end of this section. It is, of course, impossible to say whether the open areas between the wall posts were temporarily covered during construction before the stone-and-mudbrick walls were built. It is however noted that not having any cover on the sides of the timber frame would introduce further uplift pressure, making the uplift of the roof construction even more critical.

Let us now consider the case in which there were temporary wall surfaces in the open spaces between the wall posts before the construction of the exterior walls (scenario (c), *supra*). We calculate the wind force acting on the 3.00-metre segment of the vertical temporary wall surface, with a representative height equal to the lowest point of the roof, i.e. 1.69 m. Eurocode 1 (EN 1991-1-4) indicates a pressure coefficient of 0.8 for windward walls and 0.7 for leeward walls (see Fig. A5:5). The wind force on the temporary wall surfaces acting at half of the representative height is:

$$F_l^{wall} = \frac{q_p^R}{1.95} \times 3 \times 1.65 \times \left(\underbrace{0.8}_{\text{windward side}} + \underbrace{0.7}_{\text{leeward side}} \right) = 3.78 q_p^R.$$

Here, we reduced our capacity velocity pressure q_p^R – at the top of the building – by a factor of 1.96 to obtain the force based on the velocity pressure at the top of the temporary wall surfaces (as indicated by Eurocode 1). We can obtain this factor from the velocity pressure boundary layer in Fig. A5:4 by simply dividing the velocity pressure at 9.3 metres by the velocity pressure at 1.69 metres (in our case, for the Chalcis station). Thus, we obtain the total wind loading force acting at the top of the ‘planks’:

$$F_l^t = \frac{1.69}{\underbrace{1.95}_{\text{moment factor}}} \times F_l^{wall} + F_l^r = 21.21 q_p^R,$$

where we used a moment factor since our overturning moment capacity M_s is calculated for a force acting at the top of the ‘plank’, i.e. 1.95 metres above ground, whilst the resultant wall force F_l^{wall} acts at mid-height of the temporary wall surface, i.e. 1.69/2 metres above the ground.

Finally, the capacity velocity pressure to counter the overturning of the piles is

$$q_p^R = \frac{12.03}{21.04} = 0.57 \text{ kPa},$$

which is slightly lower than the case without temporary wall surfaces, i.e. with open areas.

Both capacity velocity pressures due to overturning, considering temporary wall surfaces or not, are lower than the action velocity pressure for Chalcis $q_p^A=0.62$ kPa. While this could potentially mean that the wind could overturn the frame, it is crucial to note that we are conservative when calculating the capacity. We considered only a 3.00-metre segment of our roof, without any diagonal bracing elements, such as those connected with the reconstructed crossbeams inside the building (see main article, Figs 4, 8 and 9), which would have significantly helped in transferring the wind load to the foundation. Moreover, we did not include any exterior stone-and-mudbrick walls, which would have increased lateral stiffness, even if the posts only leaned on them under the action of a lateral wind. This is the reason why the capacity velocity pressures due to overturning are considered less critical than the ones due to the uplift of the roof or the entire frame, despite the former having lower values.

c. Breaking of the rafters

The interdisciplinary team from the University of Notre Dame (*supra*, Introduction) has considered the breaking of the rafters as a potential failure mechanism. The wind pressure on the windward side, the weight of the thatch and the battens transfer loads to the rafters in addition to their self-weight. The rafters between the centre posts and the wall posts are the critical beam-like elements, since they have the largest span (c.6.2 metres – Appendix 3: III) compared to the rafters between the wall- and veranda posts. These rafters also have a significantly smaller span and smaller cross-sectional dimensions compared to the ridge beam. Thus, there was a potential for them to break due to bending either in the middle or at the connection with the adjacent structural elements, depending on how the joints were made.

Let us consider the two archetypical cases. First, if the joints are free to rotate with respect to the elements adjacent to the rafter, they are termed ‘simply supported’ as they can transfer only vertical and horizontal forces, but not moments. Second, if the joints are completely restrained and do not allow for differential rotation with the connecting elements, they are called ‘fixed’. The true behaviour is somewhere in the middle. Based on the reconstruction of birdsmouth joints for the sitting of the rafters on the ridge beam and the plates, as well as of simple lap joints for the joining of two adjacent rafters on the ridge beam and the plates (by means of a wooden peg) without use of lashings (see main article, Figs 7, 8, 9, 11, 12; Fig. A3:1), it is reasonable to assume that our case is closer to the ‘simply supported’ type of joint behaviour.²⁰

The moment capacity M_b of a rafter due to bending depends on the width b_r , the height t_r , and the tensile strength, as for the ‘planks’, and is:

$$M_b = \sigma \frac{b_r t_r^3}{6} = 20000 \times \frac{0.075 \times 0.15^2}{6} = 5.62 \text{ kNm.}$$

The uniformly distributed load p_l per unit length acting on each rafter (the distance between rafters being reconstructed, in a typical section across the timber frame as equal to 0.5 metres – *supra*, Introduction; Appendix 3: III; main article, Fig. 5), which is based on the resistance velocity pressure q_p^R with the corresponding pressure coefficient (0.6, see Fig. A5:5), and the weight of the battens, thatch and rafters projected normally to the rafter’s axis, is:

$$p_l = \left(\underbrace{0.075 \times 0.15 \times 5.3}_{\text{rafter}} + \underbrace{0.5 \times 0.5}_{\text{thatch}} \right) \times \cos 45^\circ + \underbrace{q_p^R \times 0.6 \times 0.5}_{\text{wind pressure}} + \underbrace{\frac{0.025^2 \times 3.14 \times 0.5 \times 5.3}{4 \times 0.3}}_{\text{battens}} \times \cos 45^\circ,$$

$$p_l = 0.22 + 0.3q_p^R.$$

If the joints of the rafters were fixed, the loading moment at the connection of the rafter to the adjacent elements would be critical. For the uniformly distributed load, this moment is:

$$M_l = \frac{p_l L_r^2}{12} = \frac{(0.22 + 0.3q_p^R) \times 6.36^2}{12} = 0.75 + 1.01q_p^R.$$

The capacity velocity pressure of the rafter based on the moment capacity is:

$$q_p^R = \frac{5.62 - 0.75}{1.01} = 4.81 \text{ kPa.}$$

If the rafters’ joints were simply supported, the loading moment in the middle of the rafter would be critical. For the uniformly distributed load, this moment is:

$$M_l = \frac{p_l L_r^2}{8} = \frac{(0.22 + 0.3q_p^R) \times 6.36^2}{8} = 1.12 + 1.52q_p^R.$$

The corresponding capacity velocity pressure to break the rafter is:

²⁰ See also note 15.

$$q_p^R = \frac{5.62 - 1.12}{1.52} = 2.96 \text{ kPa.}$$

The capacity velocity pressures for both cases are higher than the action velocity pressure $q_p^A = 0.62$ kPa for Chalcis. They are also substantially lower compared to the capacity velocity pressures for the previous damage mechanisms. This means that the rafters would be more resilient to breaking than the uplifting and/or overturning of the roof. Of course, there is still the possibility of the breaking of the carved joints; however, it is difficult to calculate this, in the absence of evidence on the exact details of these joints.

III. Additional Structural Considerations and Other Potential Damage Mechanisms

Apart from wind, we consider earthquake as another natural hazard that could induce damage to the LK-T building, since Lefkandi is located in a region with high seismicity. Therefore, we conducted a seismic analysis to compare the seismic response with the aerodynamic response of the building's timber frame. Additionally, in this section, we examine the possibility of buckling of the centre posts, which was considered by Herdt (2015, 207-8) to be a critical damage mechanism, at least with respect to the centre post C4.

a. Seismic analysis

Greece is a seismic region lying between the Eurasian and African tectonic plates, which makes earthquakes a natural hazard that can cause significant damage to structures. Lefkandi is situated within the Gulf of Evia Rift system, the most notable of which being the Atalanti Fault, inside the North Gulf of Evia Rift (Fig. A5:7).²¹ Lefkandi itself lies on an active fault 27 km long, on the northern side of the South Gulf of Evia Rift. This fault is near another, important active fault 31 km long on the southern side of the South Gulf of Evia Rift.²² Unfortunately, the earthquake record for ancient Greece only begins in the fifth century BCE, but it nevertheless shows that the island of Euboea experienced several earthquakes since ancient times, which also affected the Lefkandi region.²³ In Late Antiquity, Strabo wrote: *The whole of Eubœa is subject to earthquakes, especially the part near the strait* (10.1.9), the 'strait' being the Straits of Chalcis (8 km north-west of Lefkandi).

As already mentioned (*supra*, Introduction), typically, lightweight structures such as timber frames are less prone to earthquake damage than to wind, because earthquakes are directly proportional to the structure's mass. While this 'dynamic' component of the structural response is also present in the case of wind action, it can be of less importance compared to wind pressures. We will consider the seismic action, in order to give a perspective of its relative magnitude to the wind action.

²¹ See also Papazachos and Papazachou 1989, figs 10.3, 11.1; Ganas and Papoulia 2000, figs 7-11.

²² J. Jackson, pers. comm.

²³ The written sources record three earthquakes that affected Euboea during ancient times. The first one, probably strong ($M_L = 6.0$) earthquake, occurred in the autumn or winter of 427/426 BCE; its epicentre was seemingly Orchomenos (Boeotia) and it also affected Euboea and Athens. The second one, apparently major ($M_L = 7.0$) earthquake occurred in the late summer (October/November in the Athenian calendar) of 426 BCE; its epicentre was in Skarpheia (Maliac Gulf, Phthiotis) and, together with its associated seismic sea wave, was very destructive, affecting both sides of the Euboean, Maliac and Oreus Gulfs and causing serious damages, including the collapse of the sea wall and 700 houses at Oreus in northern Euboea. The third recorded earthquake was strong (apparent magnitude $M_L = 6.4$), it occurred c.198 BCE and affected the Cyclades and Euboea, especially Chalcis and the Lelantine Plain, where Lefkandi is located; Strabo (1.3.16) writes about this event: *'the fountains of Arethusa, a spring in Chalcis, were completely obstructed, and after some time forced for themselves another opening, and the whole island ceased not to experience shocks until a chasm was rent open in the earth in the plain of Lelanto, from which poured a river of burning mud.'* (transl. by H. C. Hamilton and W. Falconer, 1912). (For these three earthquakes, see: Thucydides 3.87.4 and 3.89; Diodorus Siculus 12.59; Strabo 1.3.16 and 1.3.20; Papazachos and Papazachou 1989, 113, 222-3, fig. 12.1; Ambraseys and Jackson 1998, table 1; Ambraseys 2009, 83-4; Katsetsiadou 2011, map 75; *Permanent Regional Seismological Network operated by the Aristotle University of Thessaloniki*). In later years, two further earthquakes, with magnitudes $M_L = 6.2$ and $M_L = 5.0$, respectively, occurred in the Lefkandi region in 1694 AD and in 1915 AD. Finally, two strong earthquakes, with magnitudes $M_L = 6.3$ and $M_L = 6.5$, which destroyed Thebes in 1853 AD, also caused great damage in Euboea, including Chalcis. (For these three earthquakes, see Katsetsiadou 2011, 124, map 75; *Permanent Regional Seismological Network operated by the Aristotle University of Thessaloniki*).

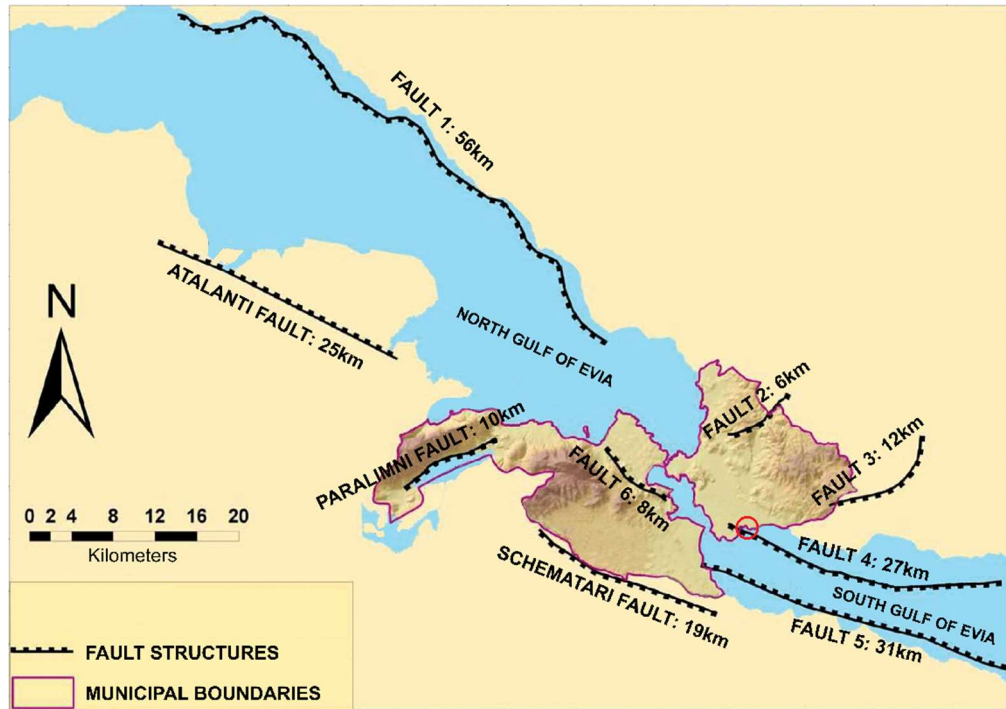


Fig. A5:7. Map of fault structures in the municipality of Chalcis (Euboea) and beyond. The red circle marks the region of Lefkandi (adapted and reproduced with kind permission from Katsetsiadou 2011, map 74).

As with the wind, we first need to quantify the earthquake hazard. The metric that describes earthquake hazard is the peak *action ground acceleration* a_{gR} on very stiff soil for a certain return period T_R . Building codes stipulate this acceleration based on past nearby earthquakes through so-called seismic hazard maps. For our purposes, we will use a seismic hazard map (Fig. A5:8) based on the 2020 European Seismic Hazard model (Danciu et al. 2021), which was developed by the European Facilities for Earthquake Hazard and Risk (EFEHR) consortium of European institutes. To have a comparable risk level with the wind hazard (*supra*), we again use a return period of 50 years. Fig. A5:8 shows the peak action ground acceleration for the region of Lefkandi based on the earth's ground acceleration $g = 9.81 \text{ m/s}^2$. The map indicates a peak ground acceleration a_{gR} between 0.075 and 0.1 of the ground acceleration; for our region, we select $a_{gR} = 0.09 \times g = 0.88 \text{ m/s}^2$.

We now need to transfer the peak action ground acceleration, in the form of a force, through the soil on the LK-T structure. For easier calculation, building codes typically assume the structure in a form of an equivalent lumped mass on a stick (also as an equivalent spring-mass system), where the stick represents the 'stiffness' of the structure. The simple method to calculate the total force is to follow Newton's second law, and factor in the flexibility of the mass-stick model. This is the basis of the Lateral Force method used in used in Eurocode 8 (EN 1998-8-1). The total force F_b , also called base shear, admitted to the structure is:

$$F_b = S_e m,$$

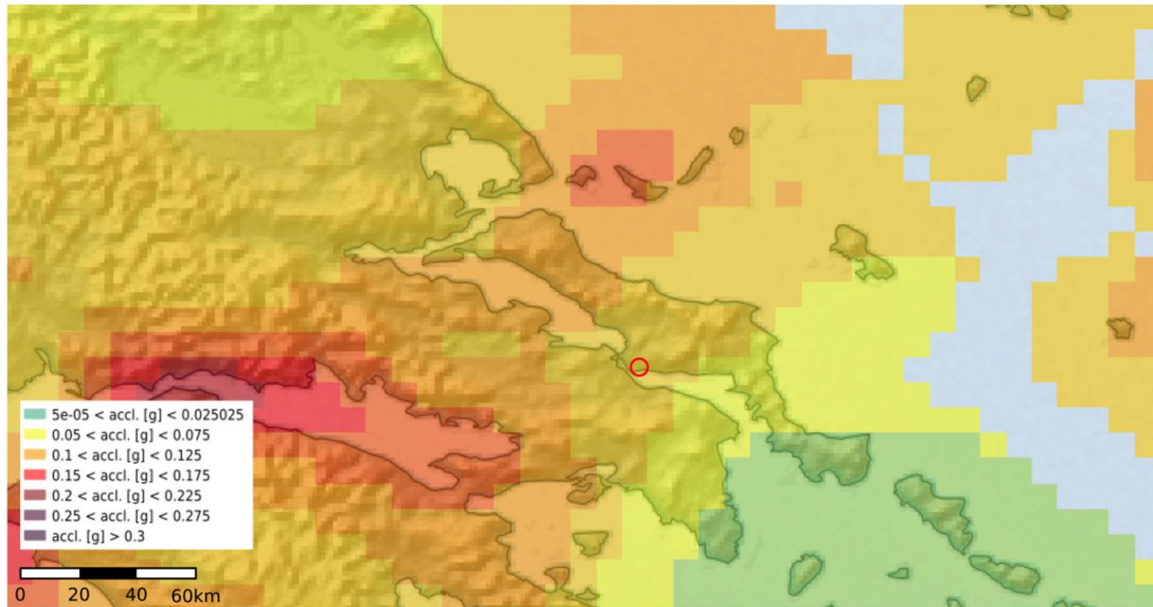


Fig. A5:8. Seismic hazard map of expected horizontal peak ground acceleration; the probability of a building constructed on rocky subsoil experiencing this is 2 % in 1 year (statistical return period of 50 years). The map shows ground motion values for a homogeneous reference rock with a v_{s30} of 800ms-1. The red circle marks the region of Lefkandi.

where m is the total mass of the structure, and $S_e = S_e(T, a_{gR})$ is the peak elastic spectral acceleration, which is based on the oscillation period of the mass-stick model T , the peak action ground acceleration a_{gR} , and the soil characteristics. As previously for the wind calculations concerning overturning, we consider the earthquake force acting on a 3.00-metre segment of the timber frame with a width of 14.40 m. The total mass for this segment is:

$$\begin{aligned}
 m = & \left(\underbrace{\frac{14.4 \times 3 \times 0.5}{\cos(45^\circ)}}_{\text{thatch}} + \underbrace{\frac{3}{0.5} \times 0.075 \times 0.15 \times 5.3 \times \frac{14.4}{\cos(45^\circ)}}_{\text{rafters}} + \underbrace{\frac{0.1 \times 0.2 \times 5.3 \times 3}{\text{ridge beam}}}_{\text{ridge beam}} \right. \\
 & + \underbrace{\frac{14.4}{0.3} \times \frac{0.025^2 \times 3.14}{4} \times 5.3 \times 3}_{\text{battens}} + \underbrace{\frac{0.22^2 \times \pi \times 5.3 \times 9.0}{4}}_{\text{centre post}} \\
 & \left. + 2 \times 2 \times 0.22 \times 0.72 \times 5.3 \left(\underbrace{4.35}_{\text{wall posts}} + \underbrace{1.95}_{\text{veranda posts}} \right) \right) \times 10^{-1} \\
 m = & 4.24 \text{ t.}
 \end{aligned}$$

The elastic spectral acceleration S_e (i.e. spectrum) takes into account the way in which the ground acceleration is admitted or ‘felt’ by the structure. Based on the dynamic properties of the structure and the surrounding soil properties, the elastic acceleration spectrum is computed as an archetype of many different types of earthquakes. Eurocode 8 (EN 1998-8-1) suggests two types of spectra: Type 1, for surface-wave magnitude greater than 5.5, and Type 2 for surface-wave magnitude lower than 5.5. These spectra, representing the normalized peak spectral acceleration with respect to the ground acceleration (i.e. S_e/a_{gR}), are depicted in Fig. A5:9 for different types of soil (A to E, where A is a rock, D is a loose-to-medium cohesion soil, and E is a mixture between C, D and A).

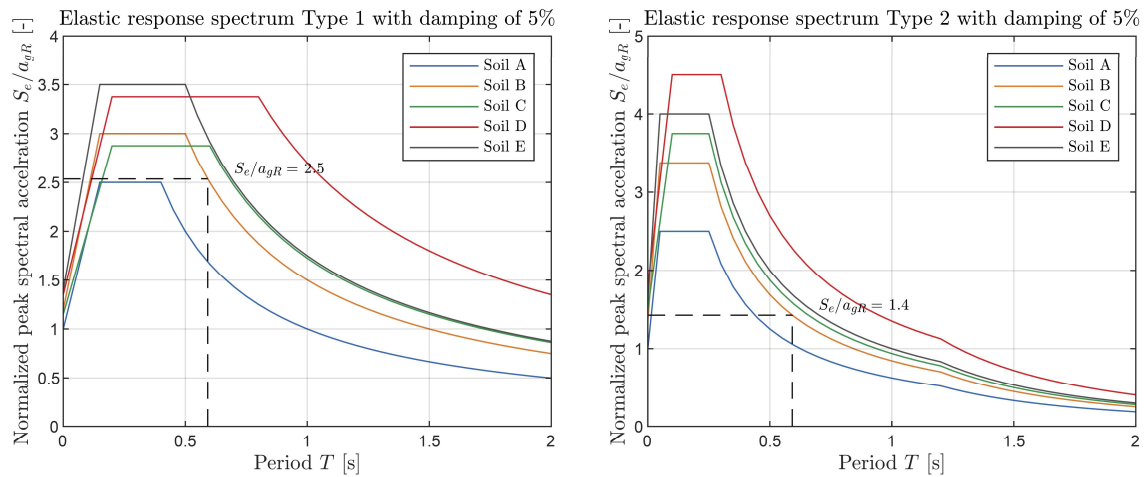


Fig. A5:9. Elastic response spectrum for 5% damping, based on Eurocode 8: Type 1 – surface-wave magnitude greater than 5.5 (left) and Type 2 – surface-wave magnitude lower than 5.5 (right).

To select the spectral acceleration specific to our structure, we need to calculate the period of oscillation T , which is one of the key values that describe the dynamics of the structures. This period can be imagined as a time needed for the mass-spring system to undergo a full back-and-forth oscillation cycle if displaced from its equilibrium condition. The period of oscillation is dependent on the mass m and stiffness of the system:

$$T = 2\pi \sqrt{\frac{m}{k}},$$

where k represents the stiffness of an equivalent spring. We obtain the stiffness based on the lateral bending stiffness of the posts in the 3.00-metre-long segment:

$$k = \sum \frac{12EI}{L^3}$$

$$= 9.5 \times 10^6 \times 12 \times \left(\underbrace{\frac{\pi \times \left(\frac{0.22}{2}\right)^4}{4 \times 9^3}}_{\text{centre post}} + 2 \times \underbrace{\frac{0.22 \times 0.072^3}{12 \times 4.35^3} \times \frac{3}{1.5}}_{\text{wall posts}} + 2 \times \underbrace{\frac{0.22 \times 0.072^3}{12 \times 1.95^3} \times \frac{3}{1.5}}_{\text{veranda posts}} \right)$$

$$k = 475.75 \text{ kN/m},$$

where the mean modulus of elasticity E was used, yielding a period of $T = 0.59$ seconds.

Since structural engineers typically use computer programs to calculate structures nowadays, the period of oscillation was also estimated numerically. To this effect, a 9.00-metre segment of the LK-T structure was modelled using the Finite Element Method, a typical method used for structural calculations, and the period of oscillation was estimated numerically. Fig. A5:10 shows the computer model (a), and two consecutive images (b-c) constituting half of an oscillation cycle (from minimum to maximum) with a period of oscillation $T = 0.63$ seconds. This shows that the simple calculations are very close to the numerical predictions, thereby verifying our analysis.

Now, all we need is the soil properties in order to select the peak spectral acceleration and obtain base shear force. The soil of LK-T is made up of a coarse conglomerate rock, quite loose and friable, ‘consisting mainly of a poorly compacted mixture of pebbles and sand’, under which is a layer of natural clay (Popham et al. 1993, 16-17, 26, 38-9). In the middle of the building, the layer of natural clay underlying the conglomerate was near the bottom of the southern burial shaft (depth of shaft: 2.63 m below the rock surface) – and therefore well below the level of the deepest post pits – while immediately below was a layer of extremely hard rock forming the floor of the tomb (Popham et al. 1993, 17-18, pl. 12). The post pits were dug in the soft conglomerate rock of the site and their filling material, which was tightly packed around the posts to stabilise them, consisted of pebbles and sand (conglomerate refill), earth, silt, clay, gravel and, in some cases, stones and mudbrick fragments (Popham et al. 1993, 10-11, 38, table 2 and *passim*).

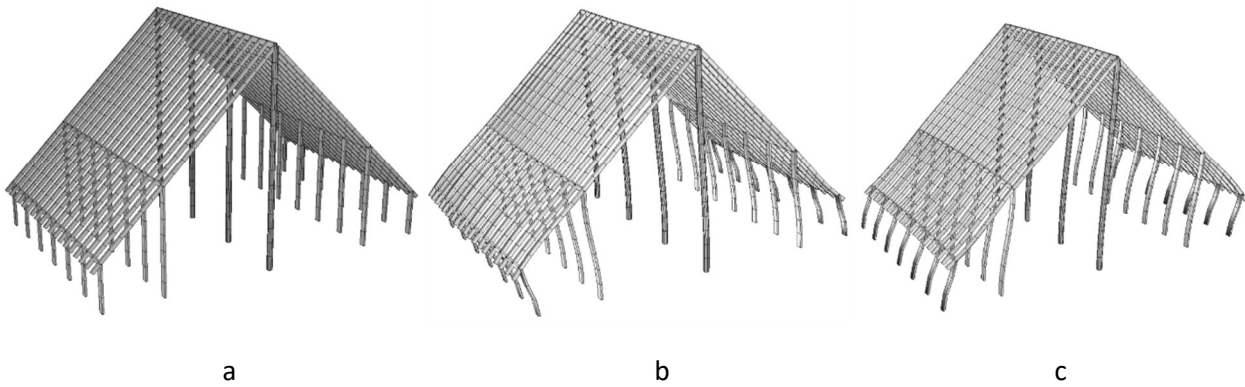


Fig. A5:10. (a) Finite Element Model of a 9.00-metre segment of the LK-T building; (b)-(c) Primary mode shape of oscillation in the lateral direction – minimum (b) to maximum (c) (i.e. half an oscillation cycle).

Although it is difficult to find an exact match between the excavators' soil descriptions and the soil types of Eurocode 8 (EN 1998-8-1), we will assume a Soil Type B, described as 'Deposits of very dense sand, gravel, or very stiff clay, at least several tens of metres in thickness, characterised by a gradual increase of mechanical properties with depth', although having a hard rock below $c.2.60$ m would probably be a Soil Type A (rock). The Type 1 spectrum yields higher peak ground acceleration for our period of 0.6 seconds, i.e. $S_e/a_{gR} = 2.53$. With this, the earthquake force acting on a 3.00-metre segment is:

$$F_b = 0.88 \times 2.53 \times 4.29 = 9.49 \text{ kN.}$$

Comparably, the total wind horizontal force that we obtained when considering pile overturning in the previous section is $F_w = 21.21q_p$. If we use Chalcis' peak action velocity pressure with a return period of 50 years, $q_p = q_p^A = 0.62$ kPa, we finally obtain a total wind force of $F_w = 13.15$ kN. The forces F_w and F_b represent the total horizontal forces exerted on the structure by wind or earthquake, respectively, both with a 2% chance of striking in any given year. Comparing both values, we can observe that the earthquake force is 38% lower than the wind. Even if we consider the worst case by opting for a Soil Type D, the peak ground acceleration would have been $S_e = 3.0$, yielding an earthquake force of $F_b = 12.78$ kN, which is still lower than the wind force for a hazard with a similar probability of occurrence.

The earthquake force would be redistributed through the LK-T structure proportionally to the mass distribution, i.e. the largest horizontal forces would be acting at the top of the posts. Therefore, we could assume that the earthquake force would act in a similar way to the horizontal wind pressure in terms of overturning the posts. As was the case with the wind overturning mechanism, any diagonal bracing elements would have significantly increased the capacity of the structure to resist earthquake forces.

In our seismic analysis, only the timber frame was considered, being the load-bearing structure. However, had the exterior stone-and-mudbrick walls been fully built, the behaviour of the structure would be changed, since they would have added further to the mass and stiffness of the building.

b. Buckling of the centre posts

Herdt (2015, 207-8) argued that the centre post C4, which has the smallest recorded diameter ($D = 0.18$ m) of all the (surviving) centre posts of the LK-T building (but see now Table A3:1; Appendix 2: Introduction), could not have reached a total height of 9.80 m (including its part buried in the ground), such as that reconstructed by the excavators (Popham et al. 1993, fig. 1) – which is also very close to the one reconstructed in this article – without buckling.²⁴ Here, we revisit the damage mechanism proposed by Herdt, using our reconstructed dimensions and hypotheses, and considering *Cupressus sempervirens* as the timber most likely to have been used in the building (see Appendix 2: I).

The buckling of the centre posts is affected by the axial force as a result of the weight of the roof transferred to the ground. Although there is differential pressure on the windward and leeward side of the roof due to wind perpendicular to the building, the wind action is mainly resisted by the overturning moment transferred to the wall- and veranda posts. For this reason, we will not take the wind into account when

²⁴ Herdt returned to this argument more recently (see Wilson Jones and Herdt 2022, 194-5).

obtaining the load. The load transferred through the centre post is then calculated as the sum of the thatch, battens, rafters, and ridge beam for the projected area of 3 x 4.5 metres corresponding to a single centre post:

$$F_l = \underbrace{0.5 \times 3 \times \frac{4.5}{\cos 45^\circ}}_{\text{thatch}} + \underbrace{\frac{3}{0.5} \times 0.075 \times 0.15 \times 5.3 \times \frac{4.5}{\cos 45^\circ}}_{\text{rafters}} + \underbrace{0.1 \times 0.2 \times 5.3 \times 3}_{\text{ridge beam}} + \underbrace{\frac{4.5}{0.3} \times \frac{0.025^2 \times 3.14}{4}}_{\text{battens}} \times 5.3 \times 3,$$

$$F_l = 12.26 \text{ kN.}$$

This gives us the ‘action’ force that is needed to be resisted by the centre post. We use Euler’s buckling theory to determine the critical capacity buckling load:

$$F^R = \frac{\pi^2 EI}{(KL)^2} = \frac{\pi^3 ED^4}{64(KL)^2},$$

where $D = 0.22$ m is the average centre post diameter, $E = 6400$ MPa is the characteristic modulus of elasticity, $L = 9.0$ m is the post length, and K is an effective length factor that depends on the ‘degree of fixity’ at the ends of the post, i.e. the fixity of the rotation and translation. Both ends of the post are fixed in translation. The bottom end of the post is fixed in rotation since it is embedded in the ground. Depending on the rotational fixity of the top joint, the effective length factor is either $K = 0.7$ for a ‘pinned’ top joint (i.e. allowing rotation) and $K = 0.5$ for a ‘fixed’ top joint (i.e. not allowing rotation). The real behaviour is somewhere in-between fixed and pinned conditions.²⁵

We will calculate the bounds of capacity, considering that the post is constrained. The buckling load for a fixed top joint is $F^R = 358.7$ kN and for a pinned top joint is $F^R = 183.0$ kN. Even if we consider the diameter of $D = 0.18$ m, these resistances are $F^R = 173.2$ kN and $F^R = 84.8$ kN, for a fixed and a pinned top joint, respectively. Thus, the buckling of a centre post of the LK-T timber frame in its reconstruction proposed here, is unlikely.

DISCUSSION

We conducted a structural analysis considering the timber frame of the LK-T building as fully load bearing and as standing alone prior to the construction of the walls. We do not see signs of significant structural damage (such as overturned posts and damaged post pits, broken posts, fallen timbers, etc.)²⁶ and there may not have been any. Dealing therefore with insufficient evidence of certain structural failures, we can only postulate hypotheses of potential damage and indicate the most probable ones.

If there has been structural damage to the timber frame, a wind uplift seems to be the most likely cause. This is consistent with the excavators’ hypothesis of a potential structural damage due to high wind and especially wind uplift forces (*supra*, Introduction). Depending on the gust intensity and the joints, the wind could have uplifted the thatch, the roof or even the whole timber frame, along with the roof. Internal pressures due to local damage or to openings (such as a gable opening likely not yet closed and a wide entrance opening at the façade), the veranda, and the roof overhang over the Porch, which have not been considered, could also have increased the uplift pressure.

The uplifting of the thatch appears to be the most likely scenario. The thatch could have flown away after the ties that attached it to the battens and probably also those that attached the battens to the rafters were broken. If the traces of thatch on the floor of the building (see main article: Introduction) are the result of a thatch uplift, the latter would have been partial; the remaining thatch would then have been brought down

²⁵ Herdt considers an effective length factor $K = 1$ based on the two joints of the post allowing rotations (i.e. pinned); however, we deem taking the bottom end of the post as pinned to be too conservative, since if the centre post was able to rotate, the wind would be a much more determining factor in structural integrity. The University of Notre Dame team (*supra*, Introduction) considered effective length factors of $K = 0.5$ and $K = 0.7$, similar to those used in the present work.

²⁶ The skewed or misaligned wall- and veranda posts at the east end of the building (see main article: Introduction), if not simply due to being pushed during the process of filling-in the building from the top of the ramps, may be due to warping (see Appendix 2: I).

during the filling operations of the building. Arguing for the other two scenarios, namely the uplifting of the roof or even the entire timber frame, is more difficult, due to the lack of evidence of structural failure of the posts and their pits. In addition, had the hipped roof over the west half of the Apse Room and the surrounding veranda been installed (see main article: I, III, Fig. 12), its aerodynamic shape would have made the western end of the building less prone to wind uplift than the eastern, gable end.

The overturning of the frame due to horizontal wind forces is another scenario of damage mechanism. If horizontal load transfer elements, such as diagonal bracings, were used, particularly in conjunction with the reconstructed crossbeams inside the building (*supra*), and if the hipped roof over the western, apsidal end, whose arc shape would have contributed additionally to horizontal load transfer, had been put in place, they would have made the frame more resistant to wind.

Considering the effect of an earthquake, the frame damaging mechanism would be somewhat similar to the overturning of the frame due to horizontal wind gusts. However, even if the damaging mechanism is similar, an earthquake with a similar return period as wind generates lower forces. As with the wind overturning mechanism, any diagonal bracing element would have increased the structure's ability to resist seismic forces. But there is no definitive evidence of either of these last two scenarios.

We note that if the exterior walls, consisting of a socle of unreinforced, rubble-filled masonry with a mudbrick superstructure, had been fully erected, in close juxtaposition with the frame, as would be the case in most of the building, the behaviour of the structure would have been altered. In the event of lateral wind forces, the walls would have increased the stiffness of the structure, even if the wall posts only leaned on them, therefore increasing the structural resistance. In the event of an earthquake, such walls would be prone to damage, as in-plane or out-of-plane mechanisms, since they are brittle and attract large earthquake forces, as seen in cases of unreinforced masonry (Vlachakis et al. 2020).

The other frame damaging mechanisms such as breaking of the rafters or buckling of the centre posts seem less likely. It is important to note that we did not deal extensively with the joints between the timber structural elements due to insufficient precise information required for such an analysis. Joints often serve as the weak link in the structure.

As regards the severe inclination of the north wall of the SR in two opposite directions on either side of the doorway (see main article: Introduction), if it is not due to the filling operations at the abandonment stage of the building or to the bulldozing over this area in modern times (*contra* Popham et al. 1993, 23-24, 98), it could have been caused by an earthquake. This wall was more vulnerable than the exterior walls. Its construction was 'rough' and 'worse' comprising smaller and less well-bonded stones. The foundation appears weaker, made of smaller stones and resting on a sloping rock platform rather than an even bedding. In addition, it lacks bonding to the side walls. An earthquake could also have caused disturbance and tilting of the wall after the building was abandoned; given that almost three millennia have passed since the building was buried, this scenario seems more plausible, but we will never know for sure. Regarding the lack of an inner face in the (west half of the) south wall of the NR (see main article: Introduction), it is less likely that this is due to wind damage.

Of course, this is a game of probabilities. Having a 2% chance a year does not mean that an earthquake or wind with a particular intensity would certainly occur within 50 years. It may be that such an earthquake or wind could not happen at all during the time of the building, or it could be that a much stronger event with, for instance, a 0.2% probability occurs and causes damage. However, as already mentioned, we do not have definitive evidence of collapse or significant structural failure.

REFERENCES

- Ambraseys, N.N. 2009. *Earthquakes in the Mediterranean and Middle East: a multidisciplinary study of seismicity up to 1900* (Cambridge).
- Ambraseys, N.N. and Jackson, J.A. 1990. 'Seismicity and associated strain of Central Greece between 1890 and 1988', *Geophysical Journal International* 101, 663–708.
- Ambraseys, N.N. and Jackson, J.A. 1998, 'Faulting associated with historical and recent earthquakes in the Eastern Mediterranean region', *Geophysical Journal International* 133, 390–406.
- Anastasiopoulou, M. and Gouigouis, A. 2018. 'Ποιοτικός έλεγχος δομικής ξυλείας πεύκου' (unpublished thesis, Department of Forestry, Wood Science & Design, University of Applied Sciences of Thessaly).
- Bayford, A. 2001. 'The Management and Conversion of Timber for Building', *Eavesdropper* 18, 11-14.
- British Standard BS EN 338:2003. *Structural timber — Strength classes*.
- Cook, N.J. 1982. 'Towards better estimation of extreme values', *Journal of Wind Engineering and Industrial Aerodynamics* 9, 295-

323.

- Coucouzeli, A. 1994. *The Lefkandi Toumba Building and Social Organisation in Early Iron Age Greece* (unpublished PhD thesis, University of Cambridge).
- Danciu, L., Nandan, S., Reyes, C., Basili, R., Weatherill, G., Beauval, C., Rovida, A., Vilanova, S., Sesetyan, K., Bard, P-Y., Cotton, F., Wiemer, S. and Giardini, D. 2021. *The 2020 update of the European Seismic Hazard Model: Model Overview*, EFEHR Technical Report 001, v1.0.0 (available online <<https://doi.org/10.12686/a15>> accessed June 2023).
- ESDU 85020, 2001. *Characteristics of atmospheric turbulence near the ground. Part II: Single point data for strong winds (neutral atmosphere)*.
- ESDU 82062, 2002. *Strong winds in the atmospheric boundary layer. Part 1: Hourly-mean wind speeds*.
- Hall, N. 1988. *Thatching: A Handbook* (London).
- Eurocode 1 (EN 1991). *Action on Structures – Part 1-4: General actions – Wind actions*.
- Eurocode 5 (EN 1995). *Design of timber structures - Part 1-1: General - Common rules and rules for buildings*.
- Eurocode 8 (EN 1998). *Design of structures for earthquake resistance – Part 8-1: General rules, seismic actions and rules for buildings*.
- Fageström, K. 1988. *Greek Iron Age Architecture: Developments through changing times* (Studies in Mediterranean Archaeology 81; Göteborg).
- Ganas, A. and Papoulia, I. 2000. 'High-resolution, Digital Mapping of the Seismic Hazard within the Gulf of Evia Rift, Central Greece Using Normal Fault Segments as Line Sources', *Natural Hazards* 22, 203–23.
- Herdt, G. 2015. 'On the Architecture of the Toumba Building at Lefkandi', *BSA* 110, 203-12.
- Ismail, M.F.M., Ghorab, S.A.S. and Abbas, M.M. 2018. 'Biomass and some Mechanical Properties for Cupressus sempervirens and Corymbia citriodora Planted in Serabium Sewage Station', *Journal of Plant Production* 9.8, 637-40.
- Katsesiadou, A.-N. 2011. *Μελέτη Κινδύνου από Φυσικές Καταστροφές – Δήμος Χαλκιδέων* (unpublished thesis, University of Athens).
- Kouris, L.A.S. and Kappos, A.J. 2012. 'Detailed and simplified non-linear models for timber-framed masonry structures', *Journal of Cultural Heritage* 13.1, 47-58.
- Lagouvardos, K., Kotroni, V., Bezes, A., Koletsis, I., Kopania, T., Lykoudis, S., Mazarakis, N., Papagiannaki, K. and Vougioukas, S. 2017. 'The automatic weather stations NOANN network of the National Observatory of Athens: operation and database', *Geoscience Data Journal* 4.1, 4-16 (available online <<https://rmts.onlinelibrary.wiley.com/doi/full/10.1002/gdj3.44>> accessed December 2022).
- Lotay, Y. 2015. 'Wind Induced Damage to Roofs and Mitigations: A Comparative Study on Roofs in Bhutan and Japan' (Report presented to the Asian Disaster Reduction Center) (available online <https://www.adrc.asia/aboutus/vrdata/finalreport/2014B_BTN_fr.pdf> accessed October 2023).
- Mirski, R., Dziurka, D., Chuda-Kowalska, M., Wieruszewski, M., Kawalerczyk, J. and Trociński, A. 2020. 'The Usefulness of Pine Timber (Pinus sylvestris L.) for the Production of Structural Elements. Part I: Evaluation of the Quality of the Pine Timber in the Bending Test', *Materials* 13, 3957.
- Papazachos, V. and Papazachou, K. 1989. *Οι σεισμοί της Ελλάδας* (Thessaloniki).
- Permanent Regional Seismological Network operated by the Aristotle University of Thessaloniki*, doi:10.7914/SN/HT; available online <<http://geophysics.geo.auth.gr/ss/CATALOGS/seiscat.dat>> accessed June 2023).
- Popham, M.R., Calligas, P.G., and Sackett, L.H. (eds) 1993. *Lefkandi II. The Protogeometric Building at Toumba. Part 2: The Excavation, Architecture and Finds* (London).
- Porcu, M.C. 2017. 'Ductile Behavior of Timber Structures under Strong Dynamic Loads', in Concu, G. (ed.), *Wood in Civil Engineering* (London), 173-96.
- Treuil, R. 1983. *Le Néolithique et le Bronze Ancien Egéens* (Athens and Paris).
- Tsakanika, E. 2017. 'Minoan structural systems: earthquake-resistant characteristics. The role of timber', in S. Jusseret and M. Sintubin (eds), *Minoan Earthquakes. Breaking the Myth through Interdisciplinarity* (Leuven), 267-304.
- Tsakanika, E. 2018. 'Timber-framed structures in Greece and their earthquake performance. Timber frames reinforced by masonry? Or timber reinforcements of masonry?', *ICOMOS Inter-ISC Meeting & Colloquium 'Anti-seismic Vernacular Heritage of Anatolia and Beyond'*, 10-13 July 2018, Kastamonu, Turkey (Istanbul), 116-29.
- Vlachakis, G., Vlachaki, E. and Lourenço, P. 2020. 'Learning from failure: Damage and failure of masonry structures, after the 2017 Lesvos earthquake (Greece)', *Engineering Failure Analysis* 117, 104803 (available online <<https://doi.org/10.1016/j.engfailanal.2020.104803>> accessed June 2023).
- Wilson Jones, M. and Herdt, G. 2022. 'Virtual Collapse? Considerations of Structure in Reconstructing Greek Architecture', in D. Borbonus and E.A. Dumser (eds), *Building the Classical World* (Oxford), 189-217.